



**HAL**  
open science

# Minimum BER Receiver Filters with Block Memory for Uplink DS-CDMA Systems

Are Hjørungnes, Merouane Debbah

► **To cite this version:**

Are Hjørungnes, Merouane Debbah. Minimum BER Receiver Filters with Block Memory for Uplink DS-CDMA Systems. EURASIP Journal on Wireless Communications and Networking, 2008, 2008 (4), 12 p. hal-00353196

**HAL Id: hal-00353196**

**<https://centralesupelec.hal.science/hal-00353196>**

Submitted on 14 Jan 2009

**HAL** is a multi-disciplinary open access archive for the deposit and dissemination of scientific research documents, whether they are published or not. The documents may come from teaching and research institutions in France or abroad, or from public or private research centers.

L'archive ouverte pluridisciplinaire **HAL**, est destinée au dépôt et à la diffusion de documents scientifiques de niveau recherche, publiés ou non, émanant des établissements d'enseignement et de recherche français ou étrangers, des laboratoires publics ou privés.

## Research Article

# Minimum BER Receiver Filters with Block Memory for Uplink DS-CDMA Systems

Are Hjørungnes<sup>1</sup> and Mérouane Debbah<sup>2</sup>

<sup>1</sup> UNIK - University Graduate Center, University of Oslo, Instituttveien 25, P.O. Box 70, 2027 Kjeller, Norway

<sup>2</sup> Alcatel-Lucent Chair on Flexible Radio, École Supérieure d'Électricité, Plateau de Moulon, 3 Rue Joliot-Curie, 91192 Gif-sur-Yvette Cedex, France

Correspondence should be addressed to Are Hjørungnes, arehj@unik.no

Received 24 September 2007; Revised 28 January 2008; Accepted 10 March 2008

Recommended by Tongtong Li

The problem of synchronous multiuser receiver design in the case of direct-sequence single-antenna code division multiple access (DS-CDMA) uplink networks is studied over frequency selective fading channels. An exact expression for the bit error rate (BER) is derived in the case of BPSK signaling. Moreover, an algorithm is proposed for finding the finite impulse response (FIR) receiver filters with block memory such that the exact BER of the active users is minimized. Several properties of the minimum BER FIR filters with block memory are identified. The algorithm performance is found for scenarios with different channel qualities, spreading code lengths, receiver block memory size, near-far effects, and channel mismatch. For the BPSK constellation, the proposed FIR receiver structure with block memory has significant better BER with respect to  $E_b/N_0$  and near-far resistance than the corresponding minimum mean square error (MMSE) filters with block memory.

Copyright © 2008 A. Hjørungnes and M. Debbah. This is an open access article distributed under the Creative Commons Attribution License, which permits unrestricted use, distribution, and reproduction in any medium, provided the original work is properly cited.

## 1. INTRODUCTION

CDMA is a multiple access technique where the user separation is done neither in frequency, nor in time, but rather through the use of codes. However, the frequency selective fading channel destroys in many cases the codes separation capability and equalization is needed at the receiver. Since the beginning of the nineties, multiuser detection [1–3] has provided multiuser receivers with different performance/complexity tradeoffs. Usual target metrics concern either maximizing the likelihood, the spectral efficiency, or minimizing the mean square error. In many cases, analytical expressions of the multiuser receivers performance can be obtained which depend mainly on the noise structure, the channel impulse response, the nature of the codes, and the receiver parameters [4–7].

In the present work, minimum BER is used as a target metric for designing the DS-CDMA FIR receiver filters for BPSK signaling, where the receiver has one FIR multiple-input single-output (MISO) filter with block memory for each user. It is assumed that the system is synchronized. Various works (see, e.g., [8–10]), have minimized BER with

respect to the receiver parameters in a perfect synchronized system when the receiver is modeled by a *memoryless* block receiver filter. In [11], they have studied minimum BER receiver filter for single-user SISO systems and no transmitter filter was considered. An adaptive algorithm for finding minimum BER filters *without* block memory in the receiver filters was proposed in [12]. The case of receiver filters with block memory of a DS-CDMA system has been studied for blind equalization in [13], and the problem of CDMA receiver design has also been studied in [14], however, the problem of *minimum BER* receiver filter design for multiuser CDMA systems has to the best of our knowledge not been treated in the literature for communication over frequency selective channels.

In this contribution, a general framework based on the discrete-time equivalent low-pass representation of signals is provided. In particular, (i) exact BER expressions are derived for an uplink multiuser DS-CDMA system using *FIR receiver filters with block memory*; (ii) the significant performance improvements achieved using receiver filters with block memory are assessed; (iii) an iterative numerical algorithm is proposed based on the BER expression for finding the

complex-valued minimum BER FIR MISO receiver filters with block memory, for given spreading codes and known channel impulse responses. Note that the additive noise on the channel is complex-valued and it might be colored. Finally, (iv) several properties of the minimum BER filters with block memory are identified.

The rest of this paper is organized as follows. Section 2 introduces the DS-CDMA model and formulates the DS-CDMA receiver optimization problem mathematically. Section 3 presents the proposed solution, and Section 4 summarizes the proposed numerical optimization algorithm. In Section 5, numerical results obtained with the proposed algorithm are presented and comparisons are made against the MMSE receiver with block memory. Conclusions are drawn in Section 6. Finally, three appendices contain proofs and tools used in the article throughout.

## 2. DS-CDMA MODEL

### 2.1. Special notations

In this contribution, receiver filters with finite block memory are used in a DS-CDMA system for communication over frequency selective FIR channels. For helping the reader to keep track of the special notations, Table 1 summarizes the most important quantities used in this paper, and gives the size of these symbols. The special notation is introduced in order to solve the FIR DS-CDMA receiver filter design problem in a compact manner when the filters have finite block memory.

In this article, all the indexing begins with 0. Let  $\mathbf{A}(z) = \sum_{i=0}^{\eta} \mathbf{A}(i)z^{-i}$  be an FIR MIMO filter of order  $\eta$  and size  $M_0 \times M_1$ , such that the block memory of the filter is  $\eta$ . The matrix  $\mathbf{A}(i)$  is the  $i$ th coefficient (note that the argument indicates whether the matrix is in the time domain  $\mathbf{A}(i)$  or in the Z-domain  $\mathbf{A}(z)$ . We want to consequently use uppercase bold symbols for matrices and lowercase boldface symbols for vectors, and that is the reason why we have chosen this convention.) of the FIR MIMO filter  $\mathbf{A}(z)$  and it has size  $M_0 \times M_1$ . The *row-expanded* matrix  $\mathbf{A}_-$  obtained from the FIR MIMO filter  $\mathbf{A}(z)$  is an  $M_0 \times (\eta + 1)M_1$  matrix given by  $\mathbf{A}_- = [\mathbf{A}(0), \mathbf{A}(1), \dots, \mathbf{A}(\eta)]$ .

Let  $q$  be a nonnegative integer. The *row-diagonal-expanded* matrix  $\mathbf{A}_-^{(q)}$  of the FIR MIMO filter  $\mathbf{A}(z)$  of order  $q$  is a  $(q + 1)M_0 \times (\eta + q + 1)M_1$  block Toeplitz matrix given by:

$$\mathbf{A}_-^{(q)} = \begin{bmatrix} \mathbf{A}(0) & \cdots & \mathbf{A}(\eta) & \cdots & \mathbf{0} \\ \vdots & \ddots & \ddots & \ddots & \vdots \\ \mathbf{0} & \mathbf{A}(0) & \cdots & \cdots & \mathbf{A}(\eta) \end{bmatrix}. \quad (1)$$

Let  $\nu$  be a nonnegative integer. The symbol  $n$  is used as a time index in this article and  $n$  is an integer. Let  $\mathbf{y}(n)$  be a vector time-series of size  $M \times 1$ . The column expansion of  $\mathbf{y}(n)$  of order  $\nu$  has size  $(\nu + 1)M \times 1$  and is defined as  $\mathbf{y}(n)_-^{(\nu)} = [\mathbf{y}^T(n), \mathbf{y}^T(n - 1), \dots, \mathbf{y}^T(n - \nu)]^T$ , where the operator  $(\cdot)^T$  denotes transposition.

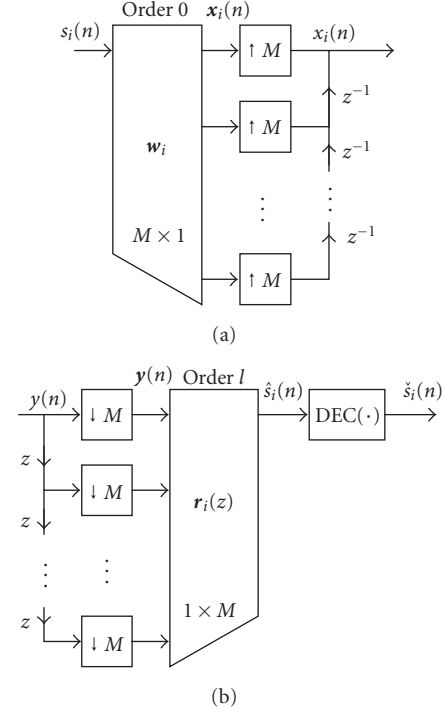

FIGURE 1: (a) DS-CDMA transmitter number  $i$ . (b) DS-CDMA receiver part designed for decoding user number  $i$ .

### 2.2. Transmission model for user number $i$

Let the number of users be  $N$ . It is assumed that the sequence of equally likely BPSK information bits  $s_i(n) \in \{-1, 1\}$  sent by user number  $i \in \{0, 1, \dots, N - 1\}$  is an independent and identically distributed time-series, uncorrelated with the additive channel noise and the data sequences sent by the other users.  $s_i(n)$  are spread with a spreading code having spreading factor  $M$ . Let the vector  $\mathbf{w}_i$  be an  $M \times 1$  vector containing the spreading code for user number  $i$ . The vector  $\mathbf{w}_i$  is an FIR single-input multiple-output (SIMO) filter without block memory that increases the sampling rate of the original signal by the factor  $M$ . It is assumed that the receiver knows the values of all the vectors  $\mathbf{w}_i$ , and they can be chosen arbitrarily, that is,  $\mathbf{w}_i \in \mathbb{C}^{M \times 1}$ , where  $\mathbb{C}$  denotes the set of complex numbers, such that any complex-valued (or real-valued) spreading code might be used. Figure 1(a) shows the  $i$ th transmitter of the DS-CDMA system and the DS-CDMA receiver part that is designed to decode user number  $i$  is shown by Figure 1(b). In Figure 1,  $z^{-1}$  is the delay element,  $z$  is the advance element,  $\uparrow M$  is expansion with factor  $M$  meaning that  $M - 1$  zeros are inserted between each sample, and  $\downarrow M$  is decimation by  $M$ ; see [15]. The input sequence  $x_i(n)$  to the  $i$ th channel, see Figure 1(a), is stacked into an  $M \times 1$  vector  $\mathbf{x}_i(n)$  according to  $\mathbf{x}_i(n) = [x_i(Mn), x_i(Mn + 1), \dots, x_i(Mn + M - 1)]^T$ . The spreading operation may be written as  $\mathbf{x}_i(n) = \mathbf{w}_i s_i(n)$ . In order to produce the  $M \times 1$  vector  $\mathbf{y}(n)$  from a scalar time-series  $y(n)$ , see Figure 1(b), the following blocking structure is used:  $\mathbf{y}(n) = [y(nM), y(nM + 1), \dots, y(nM + M - 1)]^T$ .

Let  $p$  be a nonnegative integer. Using the previously introduced notations, the  $(p+1)M \times 1$  vector  $\mathbf{x}_i(n)_1^{(p)}$  can be expressed as  $\mathbf{x}_i(n)_1^{(p)} = \mathbf{w}_i^{(p)} s_i(n)_1^{(p)}$ , where (note that boldface is not used for the symbol  $s_i(n)_1^{(p)}$ , since this is interpreted as column-expansion operator working on the scalar time-series  $s_i(n)$ ; see also the notation introduced in Section 2.1)  $\mathbf{w}_i^{(p)} = \mathbf{I}_{p+1} \otimes \mathbf{w}_i$  has size  $(p+1)M \times (p+1)$ , where  $\mathbf{I}_{p+1}$  represents the  $(p+1) \times (p+1)$  identity matrix,  $\otimes$  is the Kronecker product, and  $s_i(n)_1^{(p)} = [s_i(n), s_i(n-1), \dots, s_i(n-p)]^T$  has size  $(p+1) \times 1$ .

The  $i$ th user has the following scalar multipath channel transfer function:  $H_i(z) = \sum_{k=0}^L h_i(k)z^{-k}$ . The maximum order of all  $N$  channels is  $L$ . It is assumed that  $L \leq M$ . When  $L \leq M$ , it is shown in [16] that the equivalent FIR MIMO channel filter  $\mathbf{C}_i(z)$  of size  $M \times M$  has order  $q = 1$ , when the blocking and unblocking operations in Figure 1 are used.  $\mathbf{C}_i(z)$  is given by  $\mathbf{C}_i(z) = \mathbf{C}_i(0) + \mathbf{C}_i(1)z^{-1}$ , where the two matrix channel coefficients are given by

$$\mathbf{C}_i(0) = \begin{pmatrix} h_i(0) & 0 & 0 & \cdots & 0 \\ \vdots & h_i(0) & 0 & \cdots & 0 \\ h_i(L) & \cdots & \ddots & \cdots & \vdots \\ \vdots & \ddots & \cdots & \ddots & 0 \\ 0 & \cdots & h_i(L) & \cdots & h_i(0) \end{pmatrix}, \quad (2)$$

$$\mathbf{C}_i(1) = \begin{pmatrix} 0 & \cdots & h_i(L) & \cdots & h_i(1) \\ \vdots & \ddots & 0 & \ddots & \vdots \\ 0 & \cdots & \ddots & \cdots & h_i(L) \\ \vdots & \vdots & \vdots & \ddots & \vdots \\ 0 & \cdots & 0 & \cdots & 0 \end{pmatrix}.$$

The channel is assumed to be corrupted by zero-mean additive Gaussian complex-valued circularly symmetric noise, denoted by  $v(n)$ , which is independent of the transmitted signals. The additive channel noise vector  $\mathbf{v}(n)$  of size  $M \times 1$  can be expressed as  $\mathbf{v}(n) = [v(Mn), v(Mn+1), \dots, v(Mn+M-1)]^T$ . The channel noise is assumed to have known second-order statistics, which might be colored in general. The autocorrelation matrix of size  $(l+1)M \times (l+1)M$  of the  $(l+1)M \times 1$  vector  $\mathbf{v}(n)_1^{(l)}$  is defined as  $\Phi_{\mathbf{v}}^{(l,M)} \triangleq \mathbb{E}[\mathbf{v}(n)_1^{(l)} (\mathbf{v}(n)_1^{(l)})^H]$ , where the operator  $(\cdot)^H$  denotes conjugate transpose. Let the variance of the components of the complex-valued Gaussian circularly symmetric additive channel noise  $\mathbf{v}(n)$  be given by  $N_0 = 1/M \text{Tr}\{\Phi_{\mathbf{v}}^{(0,M)}\}$ , where  $\text{Tr}\{\cdot\}$  is the trace operator.  $N_0$  and  $\Phi_{\mathbf{v}}^{(l,M)}$  are assumed to be known in the receiver. The average energy per bit  $E_b$  at the input of the channels is given by  $E_b = 1/N \sum_{i=0}^{N-1} \mathbb{E}[\mathbf{x}_i^H(n) \mathbf{x}_i(n)] = 1/N \sum_{i=0}^{N-1} \mathbf{w}_i^H \mathbf{w}_i$ . Let the *channel condition* be defined as the value of the energy per bit-to-noise ratio (i.e.,  $E_b/N_0$ ).

There is one receiver filter for each of the  $N$  users. Receiver filter number  $i$  takes the  $M \times 1$  input vector  $\mathbf{y}(n)$  and produces a scalar as its output; see Figure 1(b). The size of the  $i$ th receiver filter is  $1 \times M$ , and its transfer function  $\mathbf{r}_i(z)$  is given by

$$\mathbf{r}_i(z) = \sum_{k=0}^l \mathbf{r}_i(k)z^{-k}, \quad (3)$$

where  $\mathbf{r}_i(k)$ , of size  $1 \times M$ , is the filter coefficient number  $k$  of the receiver filter number  $i$ . The block memory  $l$  is assumed to be fixed and known. The developed theory is valid for any nonnegative number  $l$ , and it will be demonstrated in Section 5 that a significant gain can be achieved by using filters with memory, that is,  $l > 0$ , compared to memoryless filters, that is,  $l = 0$ . The desired signal at the output of the receiver filter number  $i$  is  $d_i(n) = s_i(n - \delta)$ , where  $\delta \in \{0, 1, \dots, l+1\}$  denotes the decision delay, and  $\delta$  is the same for all  $N$  users. Since uplink is considered, the receiver is trying to estimate the original information bits from all of the  $N$  users by means of  $N$  MISO receiver filters with block memory. At the output of the MISO receiver filter  $\mathbf{r}_i(z)$ , a decision device is used to recover the original data information bits. The blocks denoted by  $\text{DEC}(\cdot)$  estimate the information bits and its output is denoted by  $\hat{s}_i(n)$ . These estimates are found by taking the real value of a complex-valued sequence  $\hat{s}_i(n)$  and then a hard decision is made returning  $+1$  if  $\hat{s}_i(n)$  is nonnegative and  $-1$  if  $\hat{s}_i(n)$  is negative. The used memoryless decisions units are suboptimal and better performance can be obtained if more advanced soft decoding techniques are employed.

### 2.3. Block description and input-output relationship

A block description of the whole DS-CDMA system is shown in Figure 2. All the input signals of the system are assumed to be jointly wide sense stationary (WSS) (Table 1 summarizes the sizes of quantities widely used in this paper).

The row-expanded FIR filter, of size  $1 \times (l+2)$ , from the input of transmitter number  $i$  to the output of the receiver filter number  $i$  is given by  $\mathbf{r}_i \mathbf{C}_i^{(l)} \mathbf{w}_i^{(l+1)}$ . The received signal vector  $\mathbf{y}(n)$  can be expressed as

$$\mathbf{y}(n) = \sum_{i=0}^{N-1} \mathbf{C}_i \mathbf{w}_i^{(1)} s_i(n)_1^{(1)} + \mathbf{v}(n). \quad (4)$$

The vector  $s_i(n)_1^{(l+1)}$  has size  $(l+2) \times 1$ .

Let the  $(l+2)N \times 1$  vector  $\mathbf{s}^{(i)}(n)$  be defined as  $\mathbf{s}^{(i)}(n) = \mathbf{s}(n)_{(l+2)i+\delta} = \mathbf{s}(n) s_i(n - \delta)$ , where the operator  $(\cdot)_{i+\delta}$  denotes component number  $k$  of the vector it is applied to, and where the vectors  $\mathbf{s}(n)$  have size  $(l+2)N \times 1$  and are defined as

$$\mathbf{s}(n) = \left[ (s_0(n)_1^{(l+1)})^T, (s_1(n)_1^{(l+1)})^T, \dots, (s_{N-1}(n)_1^{(l+1)})^T \right]^T. \quad (5)$$

There exist  $2^{N(l+2)}$  different realizations for the vector  $\mathbf{s}(n)$  since each component of  $\mathbf{s}(n)$  is either  $-1$  or  $+1$ . Let  $\mathbf{s}_k(n)$

TABLE 1: Symbols, sizes, and descriptions of widely used quantities.

Matrix or vector symbol	Size	Description
$\mathbf{w}_i$	$M \times 1$	Spreading code for user $i$
$\mathbf{w}_{i\gamma}^{(\nu)}$	$(\nu + 1)M \times (\nu + 1)$	Row-diagonal-expanded spreading code of user $i$
$\mathbf{C}_i(z)$	$M \times M$	FIR MIMO channel filter for user $i$
$\mathbf{C}_{i\gamma}$	$M \times 2M$	Row-expanded channel filter number $i$
$\mathbf{C}_{i\gamma}^{(l)}$	$(l + 1)M \times (l + 2)M$	Row-diagonal-expanded channel filter number $i$
$\mathbf{r}_i(z)$	$1 \times M$	Receiver filter number $i$
$\mathbf{r}_{i\gamma}$	$1 \times (l + 1)M$	Row-expanded receiver filter number $i$
$s_i(n)$	$1 \times 1$	Bits sent from user $i$
$s_i(n)_ ^{(p)}$	$(p + 1) \times 1$	Column expansion of bits from user $i$
$\hat{s}_i(n)$	$1 \times 1$	Output of receiver filter $i$
$\check{s}_i(n)$	$1 \times 1$	Output of receiver $i$ after decision
$d_i(n)$	$1 \times 1$	Desired output signal of receiver $i$
$\mathbf{s}(n), \mathbf{s}_k(n)$	$(l + 2)N \times 1$	Different vectors depending on sent bits
$\mathbf{s}_k^{(i)}(n), \mathbf{s}^{(i)}(n)$	$(l + 2)N \times 1$	Different vectors depending on sent bits
$\mathbf{y}(n)$	$M \times 1$	Channel output vector
$x_i(n)$	$1 \times 1$	$i$ th channel scalar input
$\mathbf{x}_i(n)$	$M \times 1$	$i$ th channel vector input
$\mathbf{x}_i(n)_ ^{(p)}$	$(p + 1)M \times 1$	Column expansion of $i$ th channel vector input
$v(n)$	$1 \times 1$	Channel noise sample
$\mathbf{v}(n)$	$M \times 1$	Channel noise vector
$\mathbf{v}(n)_ ^{(l)}$	$(l + 1)M \times 1$	Column expansion of channel noise
$\mathbf{t}_k^{(i)}(n)_ ^{(l)}, \mathbf{t}^{(i)}(n)_ ^{(l)}$	$(l + 1)M \times 1$	Column expansion of noise-free channel output
$\Phi_{\mathbf{v}}^{(l,M)}$	$(l + 1)M \times (l + 1)M$	Noise autocorrelation matrix

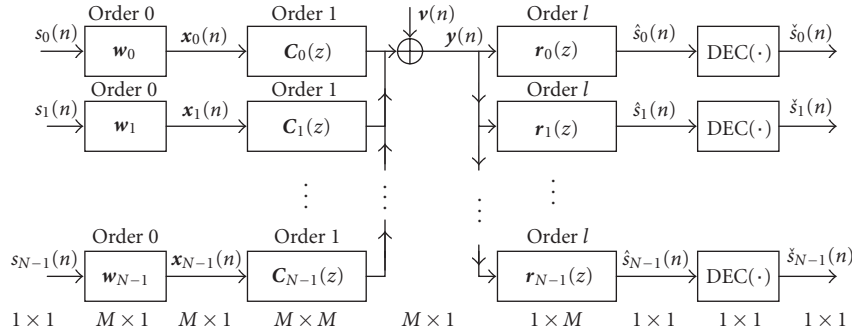
FIGURE 2: Block model of the  $N$  users DS-CDMA system.

be one of these vectors  $\mathbf{s}(n)$ , where  $k \in \{0, 1, \dots, 2^{N(l+2)} - 1\}$ , and define the  $(l + 2)N \times 1$  vector  $\mathbf{s}_k^{(i)}(n)$  as  $\mathbf{s}_k^{(i)}(n) \triangleq \mathbf{s}_k(n)(\mathbf{s}_k(n))_{(l+2)i+\delta}$ . Whenever the index  $k$  is not required,  $\mathbf{s}^{(i)}(n)$  might be used to denote one of the  $\mathbf{s}_k^{(i)}(n)$  vectors. Since  $(\mathbf{s}_k(n))_k \in \{-1, 1\}$ , the vector  $\mathbf{s}^{(i)}(n)$  will always contain  $+1$  in the vector component number  $(l + 2)i + \delta$ . Therefore, there exists a total of

$$K \triangleq 2^{(l+2)N-1} \quad (6)$$

different  $\mathbf{s}^{(i)}(n)$  vectors.

The convolution of the zero block memory SIMO filter  $\mathbf{w}_i$  and the first-order MIMO channel transfer function  $\mathbf{C}_i(z)$  is denoted by  $\mathbf{b}_i(z)$ , and  $\mathbf{b}_i(z)$  has size  $M \times 1$  and order 1. The row expansion of  $\mathbf{b}_i(z)$  is given by  $\mathbf{b}_{i\gamma} = \mathbf{C}_{i\gamma} \mathbf{w}_{i\gamma}^{(1)}$ , and  $\mathbf{b}_{i\gamma}$ ,  $\mathbf{C}_{i\gamma}$ ,

and  $\mathbf{w}_{i\gamma}^{(1)}$  have sizes  $M \times 2$ ,  $M \times 2M$ , and  $2M \times 2$ , respectively. The row-diagonal expansion of  $\mathbf{b}_i(z)$  of order  $l$  is given by  $\mathbf{b}_{i\gamma}^{(l)} = \mathbf{C}_{i\gamma}^{(l)} \mathbf{w}_{i\gamma}^{(l+1)}$ , and  $\mathbf{b}_{i\gamma}^{(l)}$ ,  $\mathbf{C}_{i\gamma}^{(l)}$ , and  $\mathbf{w}_{i\gamma}^{(l+1)}$  have sizes  $(l + 1)M \times (l + 2)$ ,  $(l + 1)M \times (l + 2)M$ , and  $(l + 2)M \times (l + 2)$ , respectively. Let the matrix  $\mathbf{T}$  be defined as  $\mathbf{T} \triangleq [\mathbf{b}_{0\gamma}^{(l)}, \mathbf{b}_{1\gamma}^{(l)}, \dots, \mathbf{b}_{N-1\gamma}^{(l)}]$ , and it has size  $(l + 1)M \times (l + 2)N$ .

The output of the  $i$ th receiver filter at time instance  $n$  is denoted by  $\hat{s}_i(n)$  and it is given by  $\hat{s}_i(n) = \mathbf{r}_{i\gamma} \mathbf{y}(n)_|^{(l)}$ . It follows from (4) that  $\mathbf{y}(n)_|^{(l)}$  is given by  $\mathbf{y}(n)_|^{(l)} = \sum_{k=0}^{N-1} \mathbf{C}_{k\gamma}^{(l)} \mathbf{w}_{k\gamma}^{(l+1)} s_k(n)_|^{(l+1)} + \mathbf{v}(n)_|^{(l)}$ . The overall expression for the output signal of the receiver filter number  $i$  can be written as

$$\hat{s}_i(n) = \mathbf{r}_{i\gamma} \mathbf{T} \mathbf{s}(n) + \mathbf{r}_{i\gamma} \mathbf{v}(n)_|^{(l)}. \quad (7)$$

## 2.4. MMSE receiver

The average mean square error (MSE) over all the  $N$  users is defined as  $\text{MSE} = 1/N \sum_{i=0}^{N-1} \text{MSE}_i$ , where  $\text{MSE}_i$  is the MSE of the  $i$ th user:  $\text{MSE}_i = \mathbb{E}[|\hat{s}_i(n) - d_i(n)|^2]$ . It can be shown that  $\text{MSE}_i$  is given by

$$\text{MSE}_i = \mathbf{r}_{i-} \Phi_{\mathbf{v}}^{(l,M)} (\mathbf{r}_{i-})^H + 1 - \mathbf{r}_{i-} \mathbf{T} \mathbf{e}_{(l+2)+\delta} + (\mathbf{e}_{(l+2)+\delta})^H \mathbf{T}^H (\mathbf{r}_{i-})^H + \mathbf{r}_{i-} \mathbf{T} \mathbf{T}^H (\mathbf{r}_{i-})^H, \quad (8)$$

where  $\mathbf{e}_k$  is the unit vector of size  $(l+2)N \times 1$  with +1 in position number  $k$  and zeros elsewhere. By calculating the derivative with respect to  $\mathbf{r}_{i-}^*$ , where  $(\cdot)^*$  means complex conjugation, the MMSE receiver filter (the MMSE filters are called Wiener filters; see for example [17]) number  $i$  is given by

$$\mathbf{r}_{i-} = (\mathbf{e}_{(l+2)+\delta})^T \mathbf{T}^H [\mathbf{T} \mathbf{T}^H + \Phi_{\mathbf{v}}^{(l,M)}]^{-1}. \quad (9)$$

## 2.5. Definitions

For the DS-CDMA receiver optimization, the following inner product will be used: for  $\mathbf{b}_i \in \mathbb{C}^{1 \times (l+1)M}$  a complex-valued row vector, then the *receiver inner product* is defined as

$$\langle \mathbf{b}_0, \mathbf{b}_1 \rangle_{\Phi_{\mathbf{v}}^{(l,M)}} = \mathbf{b}_0 \Phi_{\mathbf{v}}^{(l,M)} \mathbf{b}_1^H. \quad (10)$$

It can be shown that the following inequality is valid:

$$\text{Re}\{\langle \mathbf{b}_0, \mathbf{b}_1 \rangle_{\Phi_{\mathbf{v}}^{(l,M)}}\} \leq \|\mathbf{b}_0\|_{\Phi_{\mathbf{v}}^{(l,M)}} \|\mathbf{b}_1\|_{\Phi_{\mathbf{v}}^{(l,M)}}, \quad (11)$$

with equality holding if and only if  $\mathbf{b}_0 = \beta \mathbf{b}_1$  for an arbitrary positive constant  $\beta$ . The *receiver norm* is defined by

$$\|\mathbf{b}_0\|_{\Phi_{\mathbf{v}}^{(l,M)}} = \sqrt{\langle \mathbf{b}_0, \mathbf{b}_0 \rangle_{\Phi_{\mathbf{v}}^{(l,M)}}}. \quad (12)$$

Let  $\Phi_{\mathbf{v}}^{(l,M)} = \text{Re}\{\Phi_{\mathbf{v}}^{(l,M)}\} + j \text{Im}\{\Phi_{\mathbf{v}}^{(l,M)}\}$ , where the operators  $\text{Re}\{\cdot\}$  and  $\text{Im}\{\cdot\}$  denote the real and imaginary parts of the matrix they are applied to and  $j = \sqrt{-1}$  is the imaginary unit. It can be shown that the real-valued matrix  $\text{Re}\{\Phi_{\mathbf{v}}^{(l,M)}\}$  is symmetric and that the real-valued matrix  $\text{Im}\{\Phi_{\mathbf{v}}^{(l,M)}\}$  is skew-symmetric. Let also the real matrix  $\Phi \in \mathbb{R}^{2(l+1)M \times 2(l+1)M}$  be defined as

$$\Phi = \begin{bmatrix} \text{Re}\{\Phi_{\mathbf{v}}^{(l,M)}\} & \text{Im}\{\Phi_{\mathbf{v}}^{(l,M)}\} \\ -\text{Im}\{\Phi_{\mathbf{v}}^{(l,M)}\} & \text{Re}\{\Phi_{\mathbf{v}}^{(l,M)}\} \end{bmatrix}. \quad (13)$$

It can be shown that the matrix  $\Phi$  is symmetric. Since

$$\begin{aligned} \text{Re}\{\langle \mathbf{b}_0, \mathbf{b}_1 \rangle_{\Phi_{\mathbf{v}}^{(l,M)}}\} &= [\text{Re}\{\mathbf{b}_0\} \text{Im}\{\mathbf{b}_0\}] \Phi [\text{Re}\{\mathbf{b}_1^t\} \text{Im}\{\mathbf{b}_1^t\}]^t \\ &\triangleq \langle [\text{Re}\{\mathbf{b}_0\} \text{Im}\{\mathbf{b}_0\}], [\text{Re}\{\mathbf{b}_1\} \text{Im}\{\mathbf{b}_1\}] \rangle_{\Phi}, \end{aligned} \quad (14)$$

the value of  $\text{Re}\{\langle \mathbf{b}_0, \mathbf{b}_1 \rangle_{\Phi_{\mathbf{v}}^{(l,M)}}\}$  can be interpreted as an inner product between two vectors in  $\mathbb{R}^{1 \times 2(l+1)M}$ .

Let the symbol  $\mathbf{t}_k^{(i)}(n)_l^{(l)}$  denoting the  $k$ th vector of size  $(l+1)M \times 1$  be defined as  $\mathbf{t}_k^{(i)}(n)_l^{(l)} \triangleq \mathbf{T} \mathbf{s}_k^{(i)}(n)$ . As seen from the right-hand side of (7),  $\mathbf{t}_k^{(i)}(n)_l^{(l)}$  is the column vector expansion of order  $l$  of the noise-free input vector to the receiver, of size  $(l+1)M \times 1$ , when the vector  $\mathbf{s}_k^{(i)}(n)$  was sent from the transmitters. Furthermore, let  $\mathbf{t}^{(i)}(n)_l^{(l)} = \mathbf{T} \mathbf{s}^{(i)}(n)$ . The vector  $(\mathbf{t}_k^{(i)}(n)_l^{(l)})^H [\Phi_{\mathbf{v}}^{(l,M)}]^{-1}$  has size  $1 \times (l+1)M$ , and this vector is named a *receiver-signal vector*.

It is assumed that the system is synchronized such that the noise-free eye diagrams are in the middle of their analogue counterparts. The positive part of the  $i$ th noise-free eye diagram at time instant  $n$  is defined as the real part of the noise-free signal at the output of the receiver filter  $\mathbf{r}_i(z)$  at time  $n$  when the desired signal is  $d_i(n) = s_i(n-\delta) = +1$ . From (7) and Figure 2, it can be seen that  $\text{Re}\{\mathbf{r}_{i-} \mathbf{T} \mathbf{s}^{(i)}(n)\}$  is the real part of the output of the  $i$ th MISO receiver filter  $\mathbf{r}_i(z)$  at time  $n$  when the vector given by  $\mathbf{s}^{(i)}(n)$  was transmitted with no channel noise. At time  $n$ , the  $i$ th receiver filter  $\mathbf{r}_{i-}$  is trying to estimate the value of the desired signal  $d_i(n) = s_i(n-\delta)$ . In the vector  $\mathbf{s}^{(i)}(n)$ , the value corresponding to  $s_i(n-\delta)$  is equal to +1 due to the definition of  $\mathbf{s}^{(i)}(n)$ . The positive part of the  $i$ th noise-free eye diagram can be expressed as

$$\text{Re}\{\mathbf{r}_{i-} \mathbf{T} \mathbf{s}_k^{(i)}(n)\} = \text{Re}\left\{ \left\langle \mathbf{r}_{i-}, (\mathbf{t}_k^{(i)}(n)_l^{(l)})^H [\Phi_{\mathbf{v}}^{(l,M)}]^{-1} \right\rangle_{\Phi_{\mathbf{v}}^{(l,M)}} \right\}, \quad (15)$$

where  $i \in \{0, 1, \dots, N-1\}$  and  $k \in \{0, 1, \dots, K-1\}$ . If the system has an open noise-free eye diagram at the output of the  $i$ th receiver filter, then the expressions in (15) must be positive for all  $k \in \{0, 1, \dots, K-1\}$ .

*Definition 1.* Let user number  $i$  have spreading code of length  $M$  given by  $\mathbf{w}_i$  and let the  $M \times M$  channel block transfer matrices  $\mathbf{C}_i(z)$  be given. These channels are said to be  $(l, \delta)$  *linear FIR equalizable* if there exist  $N$  linear FIR MISO receiver filters  $\mathbf{r}_i(z)$  with size  $1 \times M$  and block memory  $l$ , see (3), such that all the  $N$  noise-free eye diagrams are open when the delay through the system is  $\delta$ .

Note that there exist channels that are not linear FIR equalizable for  $(l, \delta) = (0, 0)$ , but the same channels might be linear FIR equalizable for larger values of  $l$  or  $\delta$ . There exist *scalar channels* that are not linear FIR equalizable for some values of  $N$  and  $M$ , but if these values are sufficiently increased, then the communication system becomes linear FIR equalizable.

Definition 1 is similar to [11, Definition 1], where an equalizable SISO channel for the single user case was defined, without spreading codes and with no signal expansion, that is,  $M = 1$ .

*Definition 2.* The  $i$ th *receiver-signal set*  $\mathcal{R}_i$  is defined as

$$\mathcal{R}_i = \left\{ \sum_{k=0}^{K-1} g_k (\mathbf{t}_k^{(i)}(n)_l^{(l)})^H [\Phi_{\mathbf{v}}^{(l,M)}]^{-1} \mid g_k > 0 \right\}. \quad (16)$$

For linear FIR equalizable channels, it is seen from the equality in (15) that there exists at least one set of

receiver filters  $\mathbf{r}_l$  that has a positive real part of the receiver inner product with all the receiver-signal vectors. Since the receiver-signal vectors generate the set  $\mathcal{R}_i$ , see (16), the set  $\mathcal{R}_i$  is a cone when the channels are linear FIR equalizable. The sets in (16) are called *receiver-cone*, when the channels are linear FIR equalizable.

In general, for linear FIR equalizable channels, only *subsets* of the receiver-signal cones will result in open noise-free eye diagrams. From (15), it is seen that for linear FIR equalizable channels, the  $i$ th noise-free eye diagram is open if the following condition is satisfied: the vector  $\mathbf{r}_l$  lies inside the *subset* of  $\mathcal{R}_i$  that has a positive real part of receiver inner product with all the receiver-signal vectors.

Definition 2 is an extension of [11, Definition 2], because the problem considered there was for SISO single user case without spreading codes in the transmitters and without signal expansion, that is,  $M = 1$ . In the above definition, complex vectors are assumed even though the coefficients  $g_k$  are real in (16).

If the channel noise is approaching zero for linear FIR equalizable channels, then it is asymptotically optimal that all the noise-free eyes are open since this leads to a BER that approaches zero. All systems operating on equalizable channels having open noise-free eye diagrams have identical input and output signals when the original signal is in the set  $\{-1, +1\}$  and the noise is approaching zero. If the noise level is increased, then the proposed solution can be applied.

## 2.6. Exact expression of the BER

The total average BER for the system given in Figure 2 can be expressed as

$$\text{BER} = \frac{1}{N} \sum_{i=0}^{N-1} \text{BER}_i. \quad (17)$$

$\text{BER}_i$  is the BER of vector component number  $i$  of the output vector  $\check{\mathbf{s}}(n) \triangleq [\check{s}_0(n), \check{s}_1(n), \dots, \check{s}_{N-1}(n)]^T$ , and it can be expressed as

$$\begin{aligned} \text{BER}_i &= \Pr \{ \check{s}_i(n) \neq s_i(n - \delta) \} = \Pr \{ \text{Re} \{ \hat{s}_i(n) \} s_i(n - \delta) < 0 \} \\ &= \Pr \{ \text{Re} \{ \mathbf{r}_l \mathbf{T} \mathbf{s}(n) + \mathbf{r}_l \mathbf{v}(n) \} s_i(n - \delta) < 0 \} \\ &= \Pr \{ \text{Re} \{ \mathbf{r}_l \mathbf{T} \mathbf{s}^{(i)}(n) + \mathbf{r}_l \mathbf{v}(n) \} s_i(n - \delta) < 0 \} \\ &= \Pr \{ -\text{Re} \{ \mathbf{r}_l \mathbf{v}(n) \} s_i(n - \delta) > \text{Re} \{ \mathbf{r}_l \mathbf{t}^{(i)}(n) \} \} \\ &= \mathbb{E} [ \Pr \{ -\text{Re} \{ \mathbf{r}_l \mathbf{v}(n) \} s_i(n - \delta) \\ &\quad > \text{Re} \{ \mathbf{r}_l \mathbf{t}^{(i)}(n) \} \mid \mathbf{s}(n) \} ], \end{aligned} \quad (18)$$

where  $\Pr\{\cdot\}$  is the probability operator and  $\Pr\{A\} = \mathbb{E}[\Pr\{A \mid B\}]$  with the expected value taken with respect to  $B$ . In (18),  $s_i(n - \delta) = (\mathbf{s}(n))_{(l+2)i+\delta}$  and the definition of  $\mathbf{t}_k^{(i)}(n)$  were used. In order to simplify further the expression above, it is important to realize that the left-hand side of the last

inequality is a real Gaussian stochastic variable with mean and variance

$$\begin{aligned} \mathbb{E} [ -\text{Re} \{ \mathbf{r}_l \mathbf{v}(n) \} s_i(n - \delta) ] &= 0, \\ \mathbb{E} [ \text{Re}^2 \{ \mathbf{r}_l \mathbf{v}(n) \} s_i(n - \delta) ] &= \frac{1}{2} \|\mathbf{r}_l\|_{\Phi_v^{(l,M)}}^2, \end{aligned} \quad (19)$$

where  $\text{Re}^2\{\cdot\}$  denotes the *squared* value of the real part of the argument. By utilizing the distribution of the vectors  $\mathbf{s}(n)$  and  $\mathbf{s}_k^{(i)}(n)$ , the definition of the Q-function together with the results from (19), it is seen that (18) can be rewritten as

$$\begin{aligned} \text{BER}_i &= \mathbb{E} \left[ Q \left( \frac{\sqrt{2} \text{Re} \{ \mathbf{r}_l \mathbf{t}^{(i)}(n) \}}{\|\mathbf{r}_l\|_{\Phi_v^{(l,M)}}} \right) \right] \\ &= \frac{1}{K} \sum_{k=0}^{K-1} Q \left( \frac{\sqrt{2} \text{Re} \left\{ \left\langle \mathbf{r}_l, (\mathbf{t}_k^{(i)}(n)) \right\rangle^H [\Phi_v^{(l,M)}]^{-1} \right\}}{\|\mathbf{r}_l\|_{\Phi_v^{(l,M)}}} \right), \end{aligned} \quad (20)$$

where (15) was used, and where  $K$  is given by (6). The expression for BER is an extension of [9, equation (3)] to include complex variables and for the case where  $l > 0$ . For  $l = 0$ , the expression is also in accordance with [12, equation (20)], although the expression in [12] contains twice as many terms for each sum over  $k$ . The reason is that in [12], it has not been considered that the vectors  $\mathbf{s}_k^{(i)}(n)$  contain  $+1$  in vector component number  $(l+2)i + \delta$ , independently of  $k$ . Experiments show that there is an excellent match between the theoretical performance given in (17) and performance achieved by Monte Carlo simulations.

## 2.7. Receiver filter normalization and problem formulation

From (17) and (20), it can be deduced that the exact value of the BER is independent of the receiver inner product norm of the vectors  $\mathbf{r}_l$ . Therefore, there is no loss of optimality by choosing

$$\|\mathbf{r}_l\|_{\Phi_v^{(l,M)}}^2 = \mathbf{r}_l \Phi_v^{(l,M)} \mathbf{r}_l^H = 1. \quad (21)$$

The robust receiver design problem can be therefore formulated as

$$\text{Problem 1: } \min_{\{\mathbf{r}_0(z), \mathbf{r}_1(z), \dots, \mathbf{r}_{N-1}(z)\}} \text{BER}. \quad (22)$$

## 3. MINIMUM BER RECEIVER FILTER DESIGN WITH BLOCK MEMORY

### 3.1. Property of the minimum BER receiver filters

The following lemma states the importance of the receiver-signal cones when designing optimal receiver MISO filters for linear FIR equalizable channels.

**Lemma 1.** *If the channels are linear FIR equalizable, then the minimum BER  $i$ th receiver  $\mathbf{r}_l$  lies in  $\mathcal{R}_i$ .*

*Proof.* The proof of this lemma is given in Appendix A.  $\square$

### 3.2. Numerical optimization algorithm

The necessary conditions for optimality of the  $i$ th receiver filter can be expressed as  $(\partial/\partial \mathbf{r}_{i-}^*) \text{BER} = \mathbf{0}_{1 \times (l+1)M}$ . The following two conjugate derivatives will be useful:

$$\begin{aligned} \frac{\partial}{\partial \mathbf{r}_{i-}^*} \text{Re} \left\{ \mathbf{r}_{i-} \mathbf{t}_k^{(i)}(n) \right\} &= \frac{1}{2} \left( \mathbf{t}_k^{(i)}(n) \right)^H, \\ \frac{\partial}{\partial \mathbf{r}_{i-}^*} \frac{1}{\|\mathbf{r}_{i-}\|_{\Phi_{\mathbf{v}}^{(l,M)}}} &= \frac{-1}{2\|\mathbf{r}_{i-}\|_{\Phi_{\mathbf{v}}^{(l,M)}}^3} \mathbf{r}_{i-} \Phi_{\mathbf{v}}^{(l,M)}. \end{aligned} \quad (23)$$

By means of (17), (20), and the definition of the  $Q$ -function, the necessary conditions for optimality can be reformulated as

$$\begin{aligned} &\sum_{k=0}^{K-1} e^{-\text{Re}^2 \{ \mathbf{r}_{i-} \mathbf{t}_k^{(i)}(n) \} / \|\mathbf{r}_{i-}\|_{\Phi_{\mathbf{v}}^{(l,M)}}^2} \\ &\times \left\{ \text{Re} \left\{ \mathbf{r}_{i-} \mathbf{t}_k^{(i)}(n) \right\} \frac{\partial}{\partial \mathbf{r}_{i-}^*} \|\mathbf{r}_{i-}\|_{\Phi_{\mathbf{v}}^{(l,M)}}^{-1} \right. \\ &\left. + \frac{1}{\|\mathbf{r}_{i-}\|_{\Phi_{\mathbf{v}}^{(l,M)}}} \frac{\partial}{\partial \mathbf{r}_{i-}^*} \text{Re} \left\{ \mathbf{r}_{i-} \mathbf{t}_k^{(i)}(n) \right\} \right\} = \mathbf{0}_{1 \times (l+1)M}. \end{aligned} \quad (24)$$

By introducing the results from (23) into (24) and using the normalization in (21), then (25) can be rewritten as

$$\mathbf{r}_i = \frac{\sum_{k_1=0}^{K-1} e^{-\text{Re}^2 \{ \mathbf{r}_{i-} \mathbf{t}_{k_1}^{(i)}(n) \} } \left( \mathbf{t}_{k_1}^{(i)}(n) \right)^H [\Phi_{\mathbf{v}}^{(l,M)}]^{-1}}{\sum_{k_0=0}^{K-1} e^{-\text{Re}^2 \{ \mathbf{r}_{i-} \mathbf{t}_{k_0}^{(i)}(n) \} } \text{Re} \left\{ \mathbf{r}_{i-} \mathbf{t}_{k_0}^{(i)}(n) \right\}}. \quad (25)$$

Note that the solution is not explicit in  $\mathbf{r}_{i-}$ . The following result now follows immediately.

**Theorem 1.** *Assume that the channels are linear FIR equalizable and that the normalization in (21) is used, then the optimal receiver filter number  $i$  satisfies (25) and it lies in  $\mathcal{R}_i$ .*

Equation (25) reduces to [11, equation (12)] when  $N = M = 1$ , the matrix  $\Phi_{\mathbf{v}}^{(l,M)}$  is proportional to the identity matrix, and only real filters and signals are present.

The steepest decent method is used in the optimization of the  $i$ th receiver filter with memory. It can be shown that the following result holds:

$$\begin{aligned} \frac{\partial}{\partial \mathbf{r}_{i-}^*} \text{BER} &= \frac{-1}{2\sqrt{\pi}KN} \frac{1}{\|\mathbf{r}_{i-}\|_{\Phi_{\mathbf{v}}^{(l,M)}}} \sum_{k=0}^{K-1} e^{-\text{Re}^2 \{ \mathbf{r}_{i-} \mathbf{t}_k^{(i)}(n) \} / \|\mathbf{r}_{i-}\|_{\Phi_{\mathbf{v}}^{(l,M)}}^2} \\ &\times \left\{ \left( \mathbf{t}_k^{(i)}(n) \right)^H - \frac{\text{Re} \left\{ \mathbf{r}_{i-} \mathbf{t}_k^{(i)}(n) \right\}}{\|\mathbf{r}_{i-}\|_{\Phi_{\mathbf{v}}^{(l,M)}}^2} \mathbf{r}_{i-} \Phi_{\mathbf{v}}^{(l,M)} \right\}. \end{aligned} \quad (26)$$

This result is an extension [12, equation (23)] to the case of complex signals, colored circularly symmetric noise, and receiver filters with length  $(l+1)M$ , that is, block memory  $l$ . For real variables, the above equation reduces to [12, Equation (23)], except for a factor 2 which exists due to the distinct definition of the derivative used here when working

with complex variables; see [18, Appendix B]. When using the normalization in (21), then (26) can be simplified to

$$\begin{aligned} \frac{\partial}{\partial \mathbf{r}_{i-}^*} \text{BER} &= \frac{-1}{2\sqrt{\pi}KN} \sum_{k=0}^{K-1} e^{-\text{Re}^2 \{ \mathbf{r}_{i-} \mathbf{t}_k^{(i)}(n) \} } \\ &\times \left\{ \left( \mathbf{t}_k^{(i)}(n) \right)^H - \text{Re} \left\{ \mathbf{r}_{i-} \mathbf{t}_k^{(i)}(n) \right\} \mathbf{r}_{i-} \Phi_{\mathbf{v}}^{(l,M)} \right\}. \end{aligned} \quad (27)$$

### 3.3. Low $E_b/N_0$ regime

When the channel conditions are getting worse, that is,  $E_b/N_0 \rightarrow 0^+$ , one can obtain explicit expression of the minimum BER receiver. Indeed, the real fraction  $\sqrt{2} \text{Re} \{ \mathbf{r}_{i-} \mathbf{t}_k^{(i)}(n) \} / \|\mathbf{r}_{i-}\|_{\Phi_{\mathbf{v}}^{(l,M)}}$  will approach zero and then the last approximation in (B.2), in Appendix B, can be used to simplify the expression for BER <sub>$i$</sub>  as

$$\begin{aligned} \text{BER}_i &= \frac{1}{K} \sum_{k=0}^{K-1} Q \left( \frac{\sqrt{2} \text{Re} \left\{ \mathbf{r}_{i-} \mathbf{t}_k^{(i)}(n) \right\}}{\|\mathbf{r}_{i-}\|_{\Phi_{\mathbf{v}}^{(l,M)}}} \right) \approx \frac{1}{2} - \frac{1}{\sqrt{\pi} \|\mathbf{r}_{i-}\|_{\Phi_{\mathbf{v}}^{(l,M)}}} \\ &\times \text{Re} \left\{ \left\langle \mathbf{r}_{i-}, \frac{1}{K} \sum_{k=0}^{K-1} \left( \mathbf{t}_k^{(i)}(n) \right)^H [\Phi_{\mathbf{v}}^{(l,M)}]^{-1} \right\rangle_{\Phi_{\mathbf{v}}^{(l,M)}} \right\}. \end{aligned} \quad (28)$$

By means of the inequality in (11), for bad channel conditions ( $E_b/N_0 \rightarrow 0^+$ ) the optimal  $i$ th receiver filter can be designed such that

$$\begin{aligned} \mathbf{r}_{i-} &= \frac{\beta}{K} \sum_{k=0}^{K-1} \left( \mathbf{t}_k^{(i)}(n) \right)^H [\Phi_{\mathbf{v}}^{(l,M)}]^{-1} \\ &= \beta (\mathbf{e}_{(l+2)i+\delta})^T \mathbf{T}^H [\Phi_{\mathbf{v}}^{(l,M)}]^{-1}, \end{aligned} \quad (29)$$

where  $\beta$  is a positive constant chosen such that (21) is satisfied. The result in (29) is an extension to the MISO case of the *average matched receiver filter* that is found in [19]. From (29), it follows that the optimal receiver filter number  $i$  for bad channel conditions lies in the  $i$ th receiver-signal set  $\mathcal{R}_i$  given by (16). Equation (29) could also be derived by letting the fraction  $\sqrt{2} \text{Re} \{ \mathbf{r}_{i-} \mathbf{t}_k^{(i)}(n) \} / \|\mathbf{r}_{i-}\|_{\Phi_{\mathbf{v}}^{(l,M)}}$  approach zero in (24). If the channel noise is very high, it is seen from (9) that MMSE receiver number  $i$  is proportional to the result in (29).

### 3.4. High $E_b/N_0$ regime

**Proposition 1.** *If  $\text{BER} < 1/2K$ , then all the  $N$  noise-free eye diagrams are open.*

*Proof.* The proof of this proposition can be found in Appendix C.  $\square$

**Proposition 2.** *Assume that the channels are linear FIR equalizable. If the receiver FIR MISO filters are constrained to belong to the sets that have open noise-free eye diagrams and each of the receiver filters  $\mathbf{r}_{i-}$  satisfies (25), then the optimized receiver is a global minimum.*



```

Step 1: Initialization
  Choose values for  $N, M, l, q = 1, \delta, \mathbf{w}_i$ , and  $\mathbf{C}_i(z)$ , which is assumed to be known
   $\epsilon$  is chosen as the termination scalar
  Estimate the noise correlation matrix  $\Phi_v^{(l,M)}$ 
  Initialize the receiver MISO filters with memory

Step 2: DS-CDMA receiver filter optimization
  for each  $i \in \{0, 1, \dots, N-1\}$  do:
     $p = 0$ 
    repeat
       $\boldsymbol{\eta}_i^{(p)} = \frac{\partial}{\partial \mathbf{r}_{i-}^*} \text{BER} \Big|_{\mathbf{r}_{i-} = \mathbf{r}_{i-}^{(p)}} \quad (\text{use (27)})$ 
       $\lambda_p = \arg \min_{\lambda > 0} \text{BER} \Big|_{\mathbf{r}_{i-} = \mathbf{r}_{i-}^{(p)} - \lambda \boldsymbol{\eta}_i^{(p)}}$ 
       $\mathbf{r}_{i-}^{(p+1)} = \mathbf{r}_{i-}^{(p)} - \lambda_p \boldsymbol{\eta}_i^{(p)}$ 
       $\mathbf{r}_{i-}^{(p+1)} = \frac{\mathbf{r}_{i-}^{(p+1)}}{\|\mathbf{r}_{i-}^{(p+1)}\|_{\Phi_v^{(l,M)}}}$ 
       $p = p + 1$ 
    until  $\|\mathbf{r}_{i-}^{(p)} - \mathbf{r}_{i-}^{(p-1)}\|_{\Phi_v^{(l,M)}} < \epsilon$ 
  end

```

ALGORITHM 1: Pseudocode of the numerical optimization algorithm.

Only a sketch of proof is given: the receiver filters can be shown to be global optima following the same procedure that was used in [11, proof of Theorem 1] or of [8, Proposition 1] for each of the  $N$  MISO receiver filters with block memory.

When the channel condition improves, the ratio  $\sqrt{2} \text{Re}\{\mathbf{r}_{i-} \mathbf{t}_k^{(i)}(n)\} / \|\mathbf{r}_{i-}\|_{\Phi_v^{(l,M)}}$  approaches infinity. Since the function  $Q(x)$  approaches zero very fast when  $x$  approaches infinity, the following approximation of the  $\text{BER}_i$  expression can be done:

$$\begin{aligned}
 \text{BER}_i &= \frac{1}{K} \sum_{k=0}^{K-1} Q\left(\frac{\sqrt{2} \text{Re}\{\mathbf{r}_{i-} \mathbf{t}_k^{(i)}(n)\}}{\|\mathbf{r}_{i-}\|_{\Phi_v^{(l,M)}}}\right) \\
 &\approx \frac{\hat{k}}{K} Q\left(\frac{\sqrt{2} \min_{0 \leq k \leq K-1} \text{Re}\{\langle \mathbf{r}_{i-}, \mathbf{t}_k^{(i)}(n) \rangle_{\Phi_v^{(l,M)}^{-1}}\}}{\|\mathbf{r}_{i-}\|_{\Phi_v^{(l,M)}}}\right), \quad (30)
 \end{aligned}$$

where the integer  $\hat{k} \in \{1, 2, \dots, K\}$  is the number of branches in the  $i$ th noise-free eye diagram that achieve the minimum eye opening. Therefore from the first approximation in (B.2), it is seen that the optimal  $i$ th receiver filter should be designed such that the expression  $\min_{0 \leq k \leq K-1} \text{Re}\{\langle \mathbf{r}_{i-}, \mathbf{t}_k^{(i)}(n) \rangle_{\Phi_v^{(l,M)}^{-1}}\} / \|\mathbf{r}_{i-}\|_{\Phi_v^{(l,M)}}$  is maximized. This can equivalently be stated as follows: under the constraint  $\|\mathbf{r}_{i-}\|_{\Phi_v^{(l,M)}} = 1$ , maximize the expression  $\min_{0 \leq k \leq K-1} \text{Re}\{\langle \mathbf{r}_{i-}, \mathbf{t}_k^{(i)}(n) \rangle_{\Phi_v^{(l,M)}^{-1}}\}$ . In [19], an algorithm is developed to solve a problem similar to this optimization problem, but for the real SISO single user case. This algorithm can be generalized to include receiver MISO

complex multiuser case with block memory that is treated in this article, but this is not presented here due to space limitations. Since the algorithm maximizes the minimum noise-free eye diagram opening, it follows that the resulting receiver number  $i$  lies in  $\mathcal{R}_i$  for equalizable channels.

Convergence problems might occur with the steepest descent numerical optimization when the channel noise is extraordinarily small, that is, when  $E_b/N_0 \rightarrow \infty$ . The reason for this are the small values of the norm of the derivative  $\boldsymbol{\eta}_i^{(p)}$ ; see Algorithm 1. This convergence problem can be avoided by deriving a similar algorithm as the one derived in [19] for the case of good channel conditions ( $E_b/N_0 \rightarrow \infty$ ).

#### 4. NUMERICAL OPTIMIZATION ALGORITHM

The proposed way of optimizing the DS-CDMA receiver MISO filters with memory through the steepest descent method [20] is summarized with pseudocode in Algorithm 1. The whole system can be optimized for the different possible values of the delay  $\delta$ . The initial value for the MISO receiver filter coefficients with memory should be chosen appropriately. One possibility is to use filter coefficients from filters of the same block memory size, where the filters are optimized according to the MMSE criterion for a low value of  $E_b/N_0$ ; see Section 3.3. When the minimum BER receiver MISO filters with memory have been found for a certain channel condition  $E_b/N_0$ , these values can be used as initial values for other channel conditions which are close to the one already optimized.

As a termination criterion for the steepest descent method, the receiver norm of the difference between the values of receiver MISO filter number  $i$  with memory in two consecutive iterations is used, but another convergence criterion could be used as well.

The one-dimensional (1D) optimization performed in Step 2 for finding  $\lambda_p$  speeds up the convergence considerably in comparison to the use of a constant value for  $\lambda_p$ . The 1D search is done by brute force, that is, an exponentially increasing spaced grid is chosen with a strictly positive starting value from the current point in the direction of the negative derivative ( $-\eta_i^{(p)}$ ). The range of chosen values for  $\lambda$  depends on the channel quality  $E_b/N_0$  and it was chosen from a small positive number up to  $100E_b/N_0$ , where  $E_b/N_0$  is expressed in linear scale.

The proposed minimum BER filter algorithm with block memory is guaranteed to converge at least to a local minimum since at each step, the objective function is decreased and the objective function is lower bounded by zero. An alternative way to show that the proposed algorithm is guaranteed to converge is to use the global convergence theorem [20].

*Remark 1.* Note that the derivation of the linear receiver filter coefficients is performed once for each realization of the channel, but not for every symbol. The complexity of the filter optimization grows exponentially with respect to  $l$  and  $N$ ; see (6). However, the complexity of the filter *implementation* within one realization of the channel is linear. This is in contrast to the maximum likelihood detector, which has an exponential complexity for every new received symbol even though the channel stays constant.

## 5. RESULTS AND COMPARISONS

We have proposed exact average BER expressions for given channels for the DS-CDMA system, see (17) and (20), and, therefore, the BER results presented in this section is found by averaging these exact BER expressions for different channel realizations for both the proposed minimum BER receiver filters and the alternative MMSE filters presented in Section 2.4.

Let the  $(L+1) \times 1$  vector  $\mathbf{h}_i \triangleq [h_i(0), h_i(1), \dots, h_i(L)]^T$ . The channel impulse response coefficients  $h_i(k)$  were taken from a white complex Gaussian random process with zero mean and variance  $1/L+1$ . Real normalized gold codes [21] were used as spreading codes  $\mathbf{w}_i$ , the delay was chosen as  $\delta = \lfloor l+1/2 \rfloor$ , and  $v(n)$  was white.

The BER versus  $E_b/N_0$  performances of the MMSE and the minimum BER DS-CDMA systems are shown in Figure 3 for different number of users  $N$ . From Figure 3, it is seen that when  $N=1$ , the performances of the MMSE and minimum BER systems are almost the same for all values of  $E_b/N_0$ . When  $N$  is increased, the overall performance of the system is worse, however, as seen from Figure 3, there is a significant gain by using the minimum BER system compared to the minimum BER system. When the number of users are increased, the overall BER versus  $E_b/N_0$  performance of the system is worse because of multiuser interference (MUI). It is seen that the proposed system is less sensitive to MUI than the MMSE system. From Figure 3, it is seen that for example for BER =  $10^{-10}$  and  $N=5$ , about 16.5 dB in  $E_b/N_0$  can be gained by the proposed minimum BER system over the MMSE system. The proposed minimum BER system and

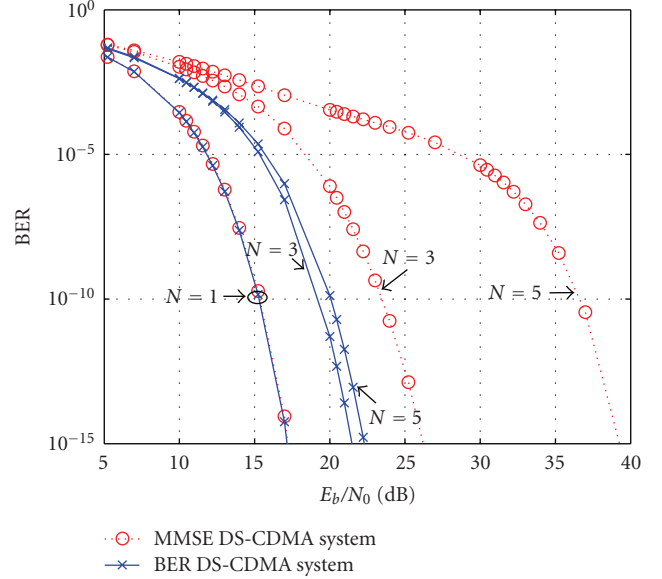

FIGURE 3: BER versus  $E_b/N_0$  performances of the MMSE DS-CDMA system ( $\cdots \circ \cdots$ ) and the proposed minimum BER DS-CDMA system ( $- \times -$ ) for different number of users  $N \in \{1, 3, 5\}$ , when  $M = 7$ ,  $L = 5$ , and  $l = 0$ . When  $N$  increases, then the performance curves move upwards.

the MMSE system have the same number of receiver filter coefficients in all the filters when equal values of  $M$ ,  $N$ ,  $L$ ,  $\delta$ , and  $l$  are used. The transmitter filters in both systems are identical. The proposed system is more complicated to design than the MMSE system, but after the filters are found, the MMSE and minimum BER filters have the same complexity. The proposed method is iterative, and when finding the minimum BER filters, several sums of  $K$  elements must be found, so the *design* complexity of the proposed algorithm is significantly higher than the closed form MMSE design complexity; see (9). However, the significant gain of the proposed system might justify the increase in design complexity, and, in addition, the proposed method can be used to find linear filters with block memory which has the minimum BER versus  $E_b/N_0$  performance.

Figure 4 shows the BER versus  $E_b/N_0$  performance for different number of users  $N$  of the proposed minimum BER DS-CDMA system and the MMSE DS-CDMA system when  $M = 31$ ,  $L = 5$ , and  $l = 0$ . Notice that the ranges of the axis of Figures 3 and 4 are different. It is seen from Figure 4 that the difference between the MMSE and minimum BER systems is very small when  $M = 31$ . It is seen that the overall performances of the systems are improved when  $M$  increases since more bandwidth is used, that is, more redundancy is introduced when  $M$  is increased. In this case, the small improvement of performance between the MMSE and the minimum BER receiver filters does not justify the increase of design complexity introduced by the proposed minimum BER receiver. These observations are in agreement with earlier publications where minimum BER and MMSE filters are compared where it is shown that when the filter length is increased in the receiver filter, the difference between the

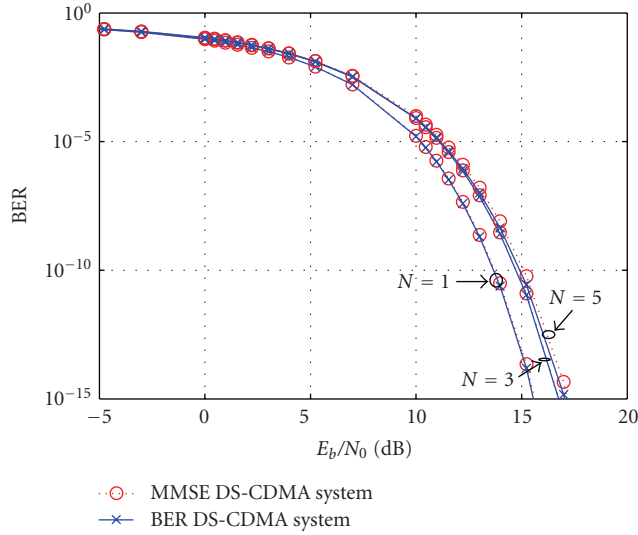

FIGURE 4: BER versus  $E_b/N_0$  performances of the MMSE DS-CDMA system ( $\cdots \circ \cdots$ ) and the proposed minimum BER DS-CDMA system ( $- \times -$ ) for different number of users  $N \in \{1, 3, 5\}$ , when  $M = 7$ ,  $L = 5$ , and  $l = 0$ . When  $N$  increases, then the performance curves move upward.

MMSE and minimum BER filters is small; see for example [11].

Figure 5 shows the BER versus  $E_b/N_0$  performances of the MMSE and the proposed minimum BER systems when  $M = 7$ ,  $L = 5$ , and  $N = 3$  and  $l \in \{0, 1, 2\}$ . When  $l$  increases, the performance of the two systems improves. From Figure 5, it is seen that a significant improvement can be achieved by increasing  $l$  from 0 to 1 in this example, however, there is only a small improvement in performance when  $l$  increases from 1 to 2. This shows that there is a significant advantage to introduce receiver filters with memory in DS-CDMA uplink communication systems.

### 5.1. Effect of channel estimation errors

It was assumed that the receiver knows exactly all the channel coefficients. This is not realistic in all practical situations. Assume that the receiver is optimized for the channel transfer functions  $C_i(z)$ , however, due to channel estimation errors, the channel coefficients used in the communication system are  $\hat{C}_i(z)$ , where the transfer functions  $C_i(z)$  and  $\hat{C}_i(z)$  have the same order and size. Let  $\hat{\mathbf{h}}_i$  contain the  $L + 1$  scalar channel coefficients corresponding to  $\hat{C}_i(z)$ . As a measure of the mismatch (MM) between the actual channels  $\hat{\mathbf{h}}_i$  and the channels used in the optimization  $\mathbf{h}_i$ ,  $MM = 1/N \sum_{i=0}^{N-1} \|\hat{\mathbf{h}}_i - \mathbf{h}_i\|^2$  is used. To generate the actual transfer function, the relation  $\hat{\mathbf{h}}_i = \mathbf{h}_i + \mathbf{q}_i$  was used, where  $\mathbf{q}_i$  has size  $(L + 1) \times 1$  and it is white complex Gaussian distributed with equal variance for each component where the variance depends on the current value of MM. It is assumed that the statistics of the error vector ( $\mathbf{q}_i$ ) stays constant for all the  $N$  channels

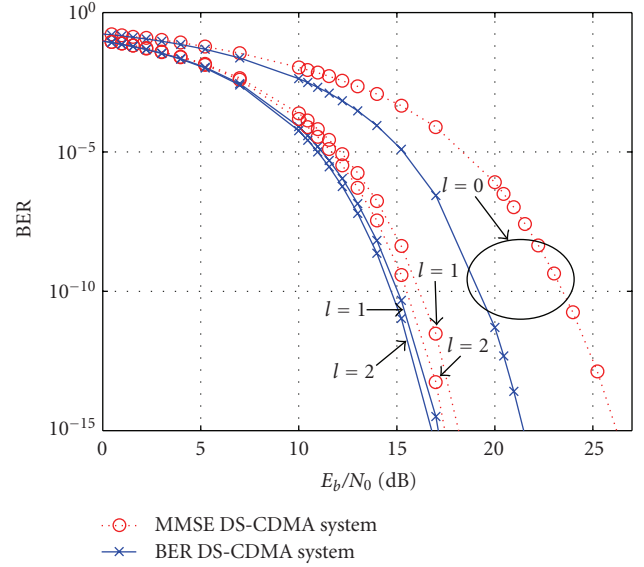

FIGURE 5: BER versus  $E_b/N_0$  performances of the MMSE DS-CDMA system ( $\cdots \circ \cdots$ ) and the proposed minimum BER DS-CDMA system ( $- \times -$ ) for different values of receiver filter memory  $l \in \{0, 1, 2\}$ , when  $M = 7$ ,  $L = 5$ , and  $N = 3$ . When  $l$  increases, then the performance curves move downward.

for a given value of the MM. When interpreting the size of MM it is important to remember that  $\mathbb{E}[\mathbf{h}_i^H \mathbf{h}_i] = 1$ . Figure 6 shows the BER versus MM performances of the MMSE and minimum BER systems. Since the value of MM depends on the realization of  $\hat{\mathbf{h}}_i$ , Monte Carlo simulations were used. 10000 realizations of the actual channels  $\hat{\mathbf{h}}_i$  were generated for each value of MM and then the BER, in (17), was averaged for all these realizations. Figure 6 gives an indication of the sensitivity of the MMSE and minimum BER receiver to errors in the channel coefficients. It is seen that the proposed minimum BER receiver is more robust against channel estimation errors than the MMSE receiver.

### 5.2. Near-far resistance effect

Let  $\mathbf{u}_i(n)$  be the noise-free  $M \times 1$  vector time-series that is the output of channel  $C_i(z)$ ; see Figure 2. Let  $P_i$  be the received signal power from user number  $i$ .  $P_i$  can be found as  $P_i = \mathbb{E}[\|\mathbf{u}_i(n)\|^2] = \text{Tr}\{C_i [\mathbf{I}_2 \otimes \mathbf{w}_i \mathbf{w}_i^H] C_i^H\}$ . Let the channel impulse responses be scaled such that all  $P_i = P$  for  $i \in \{1, 2, \dots, N - 1\}$ . The received signal power  $P_0$  from user number 0 can be different from the other received powers. The near-far ratio (NFR) in dB is defined as  $\text{NFR} = 10 \log_{10} P_0 / P$ . In Figure 7, the  $\text{BER}_0$  versus NFR performance is shown for the DS-CDMA systems using MMSE receiver filters and the proposed minimum BER receiver filters. From (17) and (20), it can be deduced that receiver filter number  $i$  is chosen such that  $\text{BER}_i$  is minimized. Since the near-far resistance is measured as  $\text{BER}_0$  versus NFR, the proposed system has optimal near-far resistance among linear receivers with block memory following the block model in Figure 2.

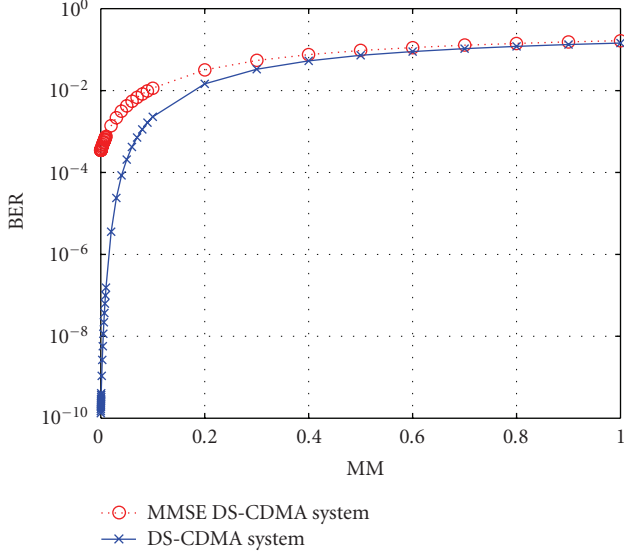

FIGURE 6: BER versus MM performances of the MMSE DS-CDMA system (· · · o · · ·) and the proposed DS-CDMA system (- × -), when  $l = 0, M = 7, L = 5, N = 5$ , and  $E_b/N_0 = 20$  dB in all cases.

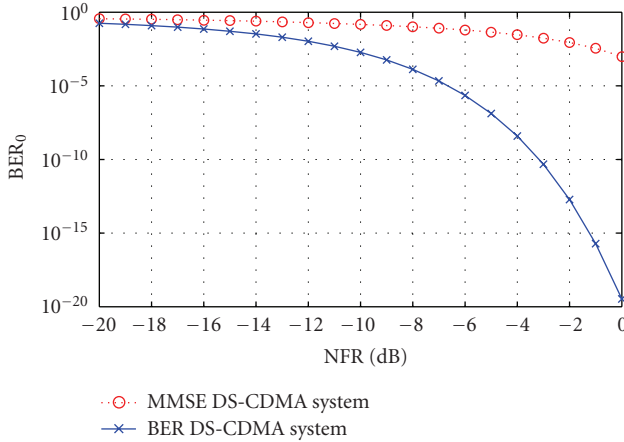

FIGURE 7:  $BER_0$  versus NFR performances of the MMSE DS-CDMA system (· · · o · · ·) and the proposed minimum BER DS-CDMA system (- × -), when  $l = 0, M = 7, L = 5, N = 5$ , and  $E_b/N_0 = 20$  dB in all cases.

**6. CONCLUSIONS**

Exact BER were derived for a DS-CDMA system using receiver filters with block memory. Based on this expression, a framework was developed for finding linear minimum BER receiver filters with block memory. A numerical iterative optimization algorithm was proposed that is able to converge to a locally optimal solution. The proposed receiver filters with block memory can be found through a numerical optimization procedure. Numerical examples showed that the proposed minimum BER receivers can perform significantly better than the MMSE receivers with the same filter memory. It was shown that by introducing memory into the receiver filters, that is, by allowing  $l > 0$ , a significant performance gain of the DS-CDMA system was

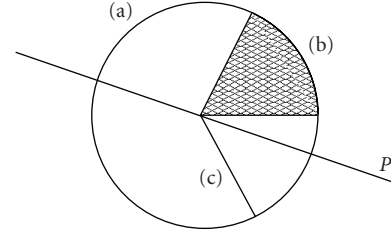

FIGURE 8: Illustration of the situation in the proof of Lemma 1. (a) represents the hypersphere in  $\mathbb{R}^{1 \times 2(l+1)M}$  with radius 1 and center at the origin. The shaded sector of (b) represents the part of the cone in  $\mathbb{R}^{1 \times 2(l+1)M}$  with vertex at the origin that is lying inside the hypersphere with respect to the receiver inner product. (c) represents the  $i$ th receiver that lies outside the cone in (b).  $P$  represents the hyperplane that lies between the cone and the  $i$ th receiver, passing through the origin, chosen such that the reflection of the  $i$  receiver using the receiver inner product about the hyperplane  $P$  lies inside the cone.

achieved. Several properties of the minimum BER filters with block memory were also identified. The results might be extended to regular constellations such as multilevel PAM, QAM, and PSK. These constellations will require a significantly larger number of vectors containing all possible sent signal combinations, such that the final SER expressions will contain a large number of terms.

**APPENDICES**

**A. PROOF OF LEMMA 1**

*Proof.* Observe first that if  $\mathbf{r}_{i-}$  has a component in the set  $\{\text{span}\{(\mathbf{t}_k^{(i)}(n))^H [\Phi_v^{(l,M)}]^{-1}\}\}^\perp$ , where the operator  $\perp$  means the orthogonal complement with respect to the receiver inner product of the set it is applied to, this component will not contribute anything to the expression of the BER, see (17) and (20), but it will reduce the length of  $\mathbf{r}_{i-}$  that can be used by  $i$ th receiver component that lies in  $\text{span}\{(\mathbf{t}_k^{(i)}(n))^H [\Phi_v^{(l,M)}]^{-1}\}$ . Therefore, the component of the optimal MISO receiver  $\mathbf{r}_{i-}$  filter that lies in  $\{\text{span}\{(\mathbf{t}_k^{(i)}(n))^H [\Phi_v^{(l,M)}]^{-1}\}\}^\perp$  is zero.

From the definition of linear FIR equalizable channels and due to the result in (14), it follows that the vectors  $[\text{Re}\{(\mathbf{t}_k^{(i)}(n))^H [\Phi_v^{(l,M)}]^{-1}\}, \text{Im}\{(\mathbf{t}_k^{(i)}(n))^H [\Phi_v^{(l,M)}]^{-1}\}] \in \mathbb{R}^{1 \times 2(l+1)M}$  form a cone whose vertex is at the origin. Assume that the optimal receiver  $[\text{Re}\{\mathbf{r}_{i-}\}, \text{Im}\{\mathbf{r}_{i-}\}]$  lies outside this cone, but on the hypersphere in  $\mathbb{R}^{1 \times 2(l+1)M}$  with radius 1 and center at the origin. Let  $P$  be a hyperplane in  $\mathbb{R}^{1 \times 2(l+1)M}$  that lies between the cone and the  $i$ th receiver, passing through the origin, chosen such that the reflection of the  $i$ th receiver with respect to the hyperplane  $P$  using the receiver inner product lies inside the cone. This situation is illustrated in Figure 8. The reflection of the receiver with respect to  $P$  using the receiver inner product then has a greater or equal receiver inner product with all the vectors that generate the cone compared to the original receiver outside the cone. Since

the  $Q$ -function is monotonic decreasing, it is clear that the BER using the reflection is smaller than when the  $i$ th receiver lies outside the cone. Since the receiver lying outside the cone and the index  $i$  were chosen arbitrarily, it is impossible that the optimal receiver filters lie outside the receiver-signal cones.  $\square$

## B. THE $Q$ -FUNCTION AND ITS APPROXIMATIONS

The  $Q$ -function is a positive monotonic decreasing function defined for real numbers  $x$  as follows:

$$Q(x) = \frac{1}{\sqrt{2\pi}} \int_x^{\infty} e^{-t^2/2} dt. \quad (\text{B.1})$$

This means that the function  $Q(x)$  is equal to the probability that a real zero-mean unit-variance Gaussian random variable is greater than the real number  $x$ . The following approximations are used [19]:

$$Q(x) \approx \begin{cases} \frac{1}{\sqrt{2\pi} x} e^{-x^2/2}, & \text{for large positive values of } x, \\ \frac{1}{2} - \frac{1}{\sqrt{2\pi}} x, & \text{for values of } x \text{ close to zero.} \end{cases} \quad (\text{B.2})$$

## C. PROOF OF PROPOSITION 1

*Proof.* Assume that not all the noise-free eyes are open. This means that there exists at least one noise-free eye that is closed, for example, the one with index number  $i$ , where  $i \in \{0, 1, \dots, N-1\}$ . From (20), it can be seen that  $\text{BER}_i \geq 1/2K$ , which implies that  $\text{BER} \geq 1/2K$ .  $\square$

## ACKNOWLEDGMENTS

The authors thank to Marius Sirbu for fruitful discussions related to this paper. Part of this work was presented in [22]. This work was supported by the Research Council of Norway project 176773/S10 called OptiMO and the Aurora project entitled "Communications under Uncertain Topologies." This work was supported by Alcatel-Lucent within the Alcatel-Lucent Chair on flexible radio at SUPELEC.

## REFERENCES

- [1] S. Verdú, "Minimum probability of error for asynchronous Gaussian multiple-access channels," *IEEE Transactions on Information Theory*, vol. 32, no. 1, pp. 85–96, 1986.
- [2] R. Lupas and S. Verdú, "Near-far resistance of multiuser detectors in asynchronous channels," *IEEE Transactions on Communications*, vol. 38, no. 4, pp. 497–507, 1990.
- [3] A. J. Viterbi, "Very low rate convolution codes for maximum theoretical performance of spread-spectrum multiple-access channels," *IEEE Journal on Selected Areas in Communications*, vol. 8, no. 4, pp. 641–649, 1990.
- [4] D. Guo and S. Verdú, "Multiuser detection and statistical mechanics," in *Communications, Information and Network Security*, V. Bhargava, H. V. Poor, V. Tarokh, and S. Yoon, Eds., pp. 229–277, chapter 13, Kluwer Academic Publishers, Dordrecht, The Netherlands, 2002.
- [5] S. Shamai and S. Verdú, "The impact of frequency-flat fading on the spectral efficiency of CDMA," *IEEE Transactions on Information Theory*, vol. 47, no. 4, pp. 1302–1327, 2001.
- [6] S. Verdú and S. Shamai, "Spectral efficiency of CDMA with random spreading," *IEEE Transactions on Information Theory*, vol. 45, no. 2, pp. 622–640, 1999.
- [7] D. Guo and S. Verdú, "Replica analysis of large-system CDMA," in *Proceedings of the IEEE Information Theory Workshop*, pp. 22–25, Paris, France, March–April 2003.
- [8] X. Wang, W.-S. Lu, and A. Antoniou, "Constrained minimum-BER multiuser detection," *IEEE Transactions on Signal Processing*, vol. 48, no. 10, pp. 2903–2909, 2000.
- [9] C.-C. Yeh, R. Lopes, and J. R. Barry, "Approximate minimum bit-error rate multiuser detection," in *Proceedings of the IEEE Global Telecommunications Conference (GLOBECOM '98)*, vol. 6, pp. 3590–3595, Sydney, Australia, November 1998.
- [10] I. N. Psaromiligkos, S. N. Batalama, and D. A. Pados, "On adaptive minimum probability of error linear filter receivers for DS-CDMA channels," *IEEE Transactions on Communications*, vol. 47, no. 7, pp. 1092–1102, 1999.
- [11] C.-C. Yeh and J. R. Barry, "Adaptive minimum bit-error rate equalization for binary signaling," *IEEE Transactions on Communications*, vol. 48, no. 7, pp. 1226–1235, 2000.
- [12] S. Chen, A. K. Samingan, B. Mulgrew, and L. Hanzo, "Adaptive minimum-BER linear multiuser detection for DS-CDMA signals in multipath channels," *IEEE Transactions on Signal Processing*, vol. 49, no. 6, pp. 1240–1247, 2001.
- [13] X. Wang and H. V. Poor, "Blind equalization and multiuser detection in dispersive CDMA channels," *IEEE Transactions on Communications*, vol. 46, no. 1, pp. 91–103, 1998.
- [14] G. B. Giannakis, Y. Hua, P. Stoica, and L. Tong, Eds., *Signal Processing Advances in Wireless and Mobile Communications*, vol. I-II, Prentice-Hall, Upper Saddle River, NJ, USA, 2001.
- [15] P. P. Vaidyanathan, *Multirate Systems and Filter Banks*, Prentice-Hall, Englewood Cliffs, NJ, USA, 1993.
- [16] A. Scaglione, G. B. Giannakis, and S. Barbarossa, "Redundant filterbank precoders and equalizers part I: unification and optimal designs," *IEEE Transactions on Signal Processing*, vol. 47, no. 7, pp. 1988–2006, 1999.
- [17] M. L. Honig, P. Crespo, and K. Steiglitz, "Suppression of near- and far-end crosstalk by linear pre- and post-filtering," *IEEE Journal on Selected Areas in Communications*, vol. 10, no. 3, pp. 614–629, 1992.
- [18] S. Haykin, *Adaptive Filter Theory*, Prentice-Hall, Englewood Cliffs, NJ, USA, 2nd edition, 1991.
- [19] P. Galko and S. Pasupathy, "Optimization of linear receivers for data communication signals," *IEEE Transactions on Information Theory*, vol. 34, no. 1, pp. 79–92, 1988.
- [20] D. G. Luenberger, *Linear and Nonlinear Programming*, Addison-Wesley, Reading, Mass, USA, 2nd edition, 1984.
- [21] D. V. Sarwate and M. B. Pursley, "Crosscorrelation properties of pseudorandom and related sequences," *Proceedings of the IEEE*, vol. 68, no. 5, pp. 593–619, 1980.
- [22] A. Hjørungnes and M. Debbah, "Minimum BER FIR receiver filters for DS-CDMA systems," in *Proceedings of the IEEE Global Telecommunications Conference (GLOBECOM '05)*, vol. 4, pp. 2287–2291, St. Louis, Mo, USA, November 2005.