



HAL
open science

Power Allocations in Minimum-Energy SER Constrained Cooperative Networks

Behrouz Maham, Are Hjorungnes, Merouane Debbah

► **To cite this version:**

Behrouz Maham, Are Hjorungnes, Merouane Debbah. Power Allocations in Minimum-Energy SER Constrained Cooperative Networks. *Annals of Telecommunications - annales des télécommunications*, 2009, 23 p. hal-00407936

HAL Id: hal-00407936

<https://centralesupelec.hal.science/hal-00407936>

Submitted on 28 Jul 2009

HAL is a multi-disciplinary open access archive for the deposit and dissemination of scientific research documents, whether they are published or not. The documents may come from teaching and research institutions in France or abroad, or from public or private research centers.

L'archive ouverte pluridisciplinaire **HAL**, est destinée au dépôt et à la diffusion de documents scientifiques de niveau recherche, publiés ou non, émanant des établissements d'enseignement et de recherche français ou étrangers, des laboratoires publics ou privés.

Power Allocations in Minimum-Energy SER Constrained Cooperative Networks

Behrouz Maham, Are Hjørungnes, and Mérouane Debbah

Abstract

In this paper, we propose minimum power allocation strategies for repetition-based amplify-and-forward (AF) relaying, given a required symbol error rate (SER) at the destination. We consider the scenario where one source and multiple relays cooperate to transmit messages to the destination. We derive the optimal power allocation strategy for two-hop AF cooperative network that minimizes the total relay power subject to the SER requirement at the destination. Two outstanding features of the proposed schemes are that the power coefficients have a simple solution and are independent of knowledge of instantaneous channel state information (CSI). We further extend the SER constraint minimum power allocation to the case of multi-branch, multihop network, and derive the closed-form solution for the power control coefficients. For the case of power-limited relays, we propose two iterative algorithms to find the power coefficients for the SER constraint minimum-energy cooperative networks. However, these power minimization strategy does not necessarily maximize the lifetime of battery-limited systems. Thus, we propose two other AF cooperative schemes which consider the residual battery energy, as well as the statistical CSI, for the purpose of lifetime maximization. Simulations show that the proposed minimum power allocation strategies could considerably save the total transmitted power compared to the equal transmit power scheme.

I. INTRODUCTION

Cooperative communications [1], [2] exploit the spatial diversity inherent in multiuser systems by allowing users with diverse channel qualities to cooperate and relay each other's

This work was supported by the Research Council of Norway through the project 176773/S10 entitled "Optimized Heterogeneous Multiuser MIMO Networks – OptiMO" and the AURORA project entitled "Communications under uncertain topologies". Preliminary version of a portion of this work is appeared in *Proc. IEEE Vehicular Technology Conference (VTC 2008-Spring)*. Behrouz Maham and Are Hjørungnes are with UNIK – University Graduate Center, University of Oslo, Norway. Behrouz Maham is currently a visiting scholar at Department of Electrical Engineering, Stanford University, USA. Mérouane Debbah is the Alcatel-Lucent Chair on Flexible Radio, SUPÉLEC, Gif-sur-Yvette, France. Emails: bmaham@stanford.edu, arehj@unik.no, merouane.debbah@supelec.fr.

messages to the destination. Each transmitted message is passed through multiple independent relay paths and, thus, the probability that the message fails to reach the destination is significantly reduced. Although each user may be equipped with only one antenna, their relays form a distributed antenna array to achieve the diversity gain of a MIMO system. Several cooperation strategies with different relaying techniques have been studied in [2], e.g., amplify-and-forward (AF), decode-and-forward (DF), selective relaying (SR), etc.. Distributed space-time codes (DSTC) have also been used to improve the bandwidth efficiency of cooperative transmissions (see, e.g., [3–5]).

Power efficiency is a critical design consideration for wireless networks such as ad-hoc and sensor networks, due to the limited transmission power of the nodes. Therefore, choosing the appropriate relays to forward the source data, as well as the transmit power levels of all the nodes become important design issues. Several power allocation strategies for relay networks were studied based on different cooperation strategies and network topologies in [6]. In [7], we proposed power allocation strategies for repetition-based cooperation that take both the statistical CSI and the residual energy information into account to prolong the network lifetime while meeting the BER QoS requirement of the destination. Distributed power allocation strategies for decode-and-forward cooperative systems are investigated in [8]. Power allocation in three-node models are discussed in [9] and [10], while multi-hop relay networks are studied in [11–13]. Recent works also discuss relay selection algorithms for networks with multiple relays, which result in power efficient transmission strategies. Recently proposed practical relay selection strategies include pre-select one relay [14], best-select relay [14], blind-selection-algorithm [15], informed-selection-algorithm [15], and cooperative relay selection [16]. In [17], an opportunistic relaying scheme is introduced. According to opportunistic relaying, a single relay among a set of R relay nodes is selected, depending on which relay provides for the *best* end-to-end path between source and destination. All of these proposed methods result in power efficient transmission strategies. However, the common theme is that, the implementation of these algorithms which are based on minimizing the received SNR require substantial feedback for estimating the instantaneous CSI of communication channels. To overcome the obstacles of these methods, average symbol error rate (SER) of the received signal can be used to design the power coefficients, which depends on the statistical CSI of channels and SER is also a more reliable criterion compared to the received SNR. Recently, in [18], a power allocation scheme was proposed based on minimizing the average SER at the destination for a single relay case. However, the achieved

SER is a function of complicated gamma functions. In contrast, in this work our objective is minimizing the transmit power given a constraint on the required SER at the destination. The asymptotic SER expression used in this paper leads to simple and efficient power allocation strategies.

In sensor networks, where the replacement of batteries is prohibitive, the problem of lifetime maximization has become increasingly important and has been extensively studied in this context (see, e.g., [19–21]). Most of the existing work in power allocation in relay networks do *not* consider the residual battery energy at each node. Without balanced energy consumption among nodes, some parts of the network may run out of battery and rapidly become nonfunctional while other parts may still have a large amount of remaining energy. To extend the network lifetime, the selection strategies based on the instantaneous CSI were used in [21] and [22]. With these strategies, the network lifetime can be extended considerably when compared to the power allocation that depends only on the channel conditions. However, in these strategies, instantaneous CSI should be available in the relays. In the sensor network literature, the network lifetime is mostly defined as the duration of time for which all sensors are active. This may not be a suitable definition since the operability of the system is not governed by the life/death of a single sensor. In the context of our interest, the network is said to be "dead" if the target SER QoS at the destination *cannot* be achieved. In this case, the death of a user due to energy depletion will cause a loss in diversity and robustness, but the system may still maintain the desired QoS.

In this paper, we propose power allocation strategies that take both the statistical CSI and the residual energy information into account to prolong the network lifetime while meeting the SER QoS requirement of the destination. In particular, we focus on the repetition-based AF cooperation scheme in an environment with one source transmitting to the destination through multiple relays that form a distributed antenna array employing the repetition-based cooperation [23]. In [21] and [22], the received instantaneous SNR at the destination is assumed as a required QoS. However, SER is a more meaningful metric to be considered as QoS. Moreover, our proposed power allocation scheme is independent of the knowledge of instantaneous CSI at the relay nodes. Thus, the proposed scheme can easily be employed in practical low-complex wireless relay networks, like sensor networks. In [23] and [24], uniform power allocation among the source and relays is assumed for a given SER constraint, which is not efficient in term of network lifetime maximization. Here, we propose algorithms that maximize the network lifetime with SER constraint in AF based cooperative networks given

in [23].

Our main contributions in this paper can be summarized as follows:

- 1) We derive the optimal power allocation strategy in AF cooperative network that minimizes the total relay power subject to the SER requirement at the destination.
- 2) We extend the SER constraint minimum power allocation scheme to the *multi-branch, multihop case*, and derive the corresponding closed-form power allocation.
- 3) We propose two iterative algorithms for finding the power control coefficients when we put an upper-bound threshold on the individual transmit power of each relay.
- 4) We propose power allocation strategies that maximize the network lifetime given a required SER constraint for energy-limited nodes in the cooperative network.

The remainder of this paper is organized as follows: In Section II, we consider power control optimization problems in multi-branch two-hop relay networks. The minimum power allocation strategies subject to the average SER requirement at the destination for multi-branch, multihop scenario are presented in Section III. In Section IV, power allocation strategies for network lifetime maximization are presented for two-hop multi-branch scheme. In Section V, the preference of the proposed schemes in terms of power minimization and lifetime maximization is demonstrated through numerical simulations. Some conclusions are presented in Section VI.

II. POWER ALLOCATION IN SER CONSTRAINT MULTI-BRANCH COOPERATIVE NETWORKS

In this section, we propose power control optimization problems in multi-branch two-hop relay networks (see Fig. 1). In the first scenario, the minimum power allocation subject to the SER constraint is considered. In the second scenario, we add another constraint on the individual power transmission from each relay.

A. System Model

We consider a wireless relay network with one source node s , one destination node d , and N passive nodes that have a capability of serving as a relay. Here, the term passive is used to show that these nodes do not have their own information to transmit and they can only be used as a relay to retransmit the source node messages. Similar assumptions are made in [25]. Each passive node is powered by a battery with E_{in} initial energy. It is assumed that each node is equipped with a single antenna. Note that by using the orthogonal

transmissions such as TDMA/OFDMA, the assumed setting can be turned into multiuser scenario. That is, in each time/frequency sub-channel, one node is considered as source and the remaining nodes act as relay nodes to retransmit the chosen source's data. Also, using the relay selection strategy based on [26], our derived power allocation schemes can be employed in networks with interference. In [26], the network is divided to relay zones (clusters). Inside each zone we can apply a two-phase cooperative scheme for a source and relays inside the relay zone. However, relays also receive interferences from the sources and relays outside of the relay zone. If the amount of signal-to-interference plus noise ratio (SINR) is higher than a certain threshold, a potential relay is selected as a relay. Then, by assuming the remaining interference as Gaussian noise, we can apply the power allocation studied in this paper to the source and relays inside each relay zone.

In [23], the amplification coefficients are chosen so that all stations in the network have the same transmit power. However, here, the optimum transmitted power from each relay will be calculated to minimize the total transmitted power subject to satisfying the required SER QoS at the destination. Using an appropriate relay selection strategy, R relays are selected among the N passive nodes in the network. Fig. 1 shows an example of a multi-branch network with R relays $\{r_1, r_2, \dots, r_R\}$. We assume that each link undergoes independent Rayleigh process. Assuming that the source and relay terminals transmit their signals through orthogonal channels, the destination terminal receives $R+1$ independent copies of the transmitted signal. Then, maximal ratio combining (MRC) is used to detect the transmitted symbols. With R relay terminals, the system SER at high signal to noise ratios is given by [27, Eq. (33)]

$$\bar{P}_e = \frac{C(R)}{k^{R+1}} \frac{1}{\gamma_{sd}} \prod_{r=1}^R \left(\frac{1}{\gamma_{sr}} + \frac{1}{\gamma_{rd}} \right), \quad (1)$$

where $C(R)$ is defined as

$$C(R) = \frac{\prod_{j=1}^{R+1} (2j-1)}{2(R+1)!},$$

k is a constant which depends on the type of modulation used (e.g., $k = 2 \sin^2(\pi/M)$ for M -PSK), and γ_{sd} , γ_{sr} , and γ_{rd} are the average signal-to-noise ratios of the source-to-destination, source-to- r th relay, and r th relay-to-destination links, respectively.

Without loss of generality, we are assuming that the additive noise has unit variance at the destination and the relays. Thus, with R relay terminals operating under amplify-and-forward

repetition based transmission, the SER in (1) can be rewritten as

$$\bar{P}_e = \frac{C(R)}{k^{R+1}} \frac{1}{\varepsilon_s \Omega_{sd}} \prod_{r=1}^R \left(\frac{1}{\varepsilon_s \Omega_{sr}} + \frac{1}{\varepsilon_r \Omega_{rd}} \right), \quad (2)$$

where ε_s and ε_r are the transmitted power from the source node and the r th relay, respectively. For any two nodes, p and q , $\Omega_{pq} = 1/d_{pq}^\nu$ is the path-loss coefficient, where $d_{p,q}$ is the distance between nodes p and q , and ν is the path-loss exponent, which typically lies in the range of $2 \leq \nu \leq 6$.

B. Minimum Power Allocation for SER Constrained Network

Unlike [23] and [24], in which uniform power allocation among the source and relays is assumed, we optimize the transmitted power by each relay by minimizing the total transmitted power from relays subject to the average SER requirement at the destination. Given the knowledge of the average channel coefficients, the power allocation problem can be formulated as

$$\begin{aligned} & \min_{\{\varepsilon_1, \dots, \varepsilon_R\}} \sum_{r=1}^R \varepsilon_r, \\ \text{s.t. } & \frac{C(R)}{k^{R+1}} \frac{1}{\varepsilon_s \Omega_{sd}} \prod_{r=1}^R \left(\frac{1}{\varepsilon_s \Omega_{sr}} + \frac{1}{\varepsilon_r \Omega_{rd}} \right) \leq \text{SER}, \\ & \varepsilon_r \geq 0, \text{ for } r = 1, \dots, R, \end{aligned} \quad (3)$$

where SER is the required QoS at the destination. Since the source node does not contribute in the second phase of the transmission, the summation in the objective function in (3) is done over the transmission power of the selected relays. Finding the optimum value of the source transmission power, ε_s , depends on the type of the multiple-access technique that select each node as a source for a given channel. Therefore, we assumed the fixed transmission power from the source node. Before deriving the optimal solution for the problem given in (3), the following theorem is presented.

Theorem 1: The optimum power allocation $\varepsilon_1, \dots, \varepsilon_R$ in the optimization problem stated in (3) is unique.

Proof: The objective function in (3) is a linear function of the power allocation parameters, and thus, it is a convex function. Hence, it is enough to prove that the first constraint in (3), i.e.,

$$f(\varepsilon_1, \dots, \varepsilon_R) = \frac{C(R)}{k^{R+1}} \frac{1}{\varepsilon_s \Omega_{sd}} \prod_{r=1}^R \left(\frac{1}{\varepsilon_s \Omega_{sr}} + \frac{1}{\varepsilon_r \Omega_{rd}} \right) - \text{SER}, \quad (4)$$

with $D_f = \{\varepsilon_r \in (0, \infty), r \in \{1, \dots, R\} \mid f(\varepsilon_1, \dots, \varepsilon_R) \leq 0\}$, $f : D_f \rightarrow \mathbb{R}$, $f(\varepsilon_1, \dots, \varepsilon_R)$ is a convex function. From [28], it can be verified that $f(\varepsilon_1, \dots, \varepsilon_R)$ is a *posynomial* function, which is a strict convex function. By showing (analytically) that the Hessian of f is positive semi-definite, it can be shown that the function is convex (on the nonnegative orthant). ■

The SER expression in (2) can be rewritten as

$$\bar{P}_e = \frac{C(R)}{k^{R+1}} \frac{1}{\varepsilon_s \Omega_{sd}} \prod_{r=1}^R g_r, \quad (5)$$

where functions g_r are defined as follows

$$g_r = \frac{1}{\varepsilon_s \Omega_{sr}} + \frac{1}{\varepsilon_r \Omega_{rd}}. \quad (6)$$

The solution of the optimal power allocation strategy in (3) is shown in the following theorem.

Theorem 2: For the set of selected relays in the network, the optimum power allocation $\varepsilon_1, \dots, \varepsilon_R$ in the optimization problem stated in (3) can be written as

$$\varepsilon_r = \frac{\varepsilon_s \Omega_{sr} C(R)}{\text{SER } k^{R+1} \varepsilon_s^2 \Omega_{sd} \Omega_{r,d} \Omega_{sr} - \Omega_{rd} C(R)} \prod_{\substack{i=1 \\ i \neq r}}^R g_i, \quad (7)$$

for $r = 1, \dots, R$.

Proof: The Lagrangian of the problem stated in (3) is

$$L(\varepsilon_1, \dots, \varepsilon_R) = \sum_{r=1}^R \varepsilon_r + \lambda f(\varepsilon_1, \dots, \varepsilon_R). \quad (8)$$

For nodes $r = 1, \dots, R$ with nonzero transmitter powers, the Kuhn-Tucker conditions are

$$\frac{\partial}{\partial \varepsilon_r} L(\varepsilon_1, \dots, \varepsilon_R) = 1 + \lambda \frac{\partial}{\partial \varepsilon_r} f(\varepsilon_1, \dots, \varepsilon_R) = 0, \quad (9)$$

where

$$\frac{\partial}{\partial \varepsilon_r} f(\varepsilon_1, \dots, \varepsilon_R) = -\frac{C(R)}{k^{R+1}} \frac{1}{\varepsilon_s \Omega_{sd}} \frac{1}{\varepsilon_r^2 \Omega_{rd}} \prod_{\substack{i=1 \\ i \neq r}}^R g_i. \quad (10)$$

Using (9) and (10), we have

$$\varepsilon_r^2 = \lambda \frac{C(R)}{k^{R+1}} \frac{1}{\varepsilon_s \Omega_{sd} \Omega_{rd}} \prod_{\substack{i=1 \\ i \neq r}}^R g_i, \quad (11)$$

for $r = 1, \dots, R$.

Since the strong duality condition [28, Eq. (5.48)] holds for convex optimization problems, we have $\lambda f(\varepsilon_1, \dots, \varepsilon_R) = 0$ for the optimum point. If we assume that the Lagrange multiplier λ has a positive value, we have $f(\varepsilon_1, \dots, \varepsilon_R) = 0$, which is equivalent to

$$\text{SER} = \frac{C(R)}{k^{R+1}} \frac{1}{\varepsilon_s \Omega_{sd}} \prod_{r=1}^R g_r. \quad (12)$$

Dividing both sides of equalities (11) and (12), we can find the Lagrange multiplier as

$$\lambda = \frac{\varepsilon_r^2}{\text{SER}} \left(\frac{\Omega_{rd}}{\varepsilon_s \Omega_{sr}} + \frac{1}{\varepsilon_r} \right). \quad (13)$$

Substituting λ from (13) into (11) we get (7).

It is important to note that ε_r in (7) is always positive. To show this, it is sufficient to show that the denominator in (7) is positive. Replacing SER from (12) in the denominator of (7), it can be verified that the inequality

$$\frac{\varepsilon_s \Omega_{sr}}{\varepsilon_r \Omega_{rd}} > 0,$$

which is always true by choosing some positive initial value for ε_r , is equivalent to the positivity of (7). Since the left side of the first constraint in (3) goes to infinity, as $\varepsilon_r \rightarrow 0$ for any r , all of the power coefficients of the optimization problem in (3) are non-zero. ■

The optimal power allocation scheme proposed in Theorem 2 can be easily solved with initializing some positive values for ε_r , $r = 1, \dots, R$, and using (7) in an iterative manner. By using Theorem 1, it is obvious that utilizing the mentioned approach leads to the optimum points of power allocation coefficients.

C. Minimum Power Allocation in SER and per Relay Power Constraint Cooperative Networks

Another scenario in SER constraint cooperative networks is that we put further constraint on the individual transmitted power from each relay. The underlying problem is more feasible compared to that studied in the previous subsection. The reason is that the limited-energy batteries usually have a certain bound on the transmitted power during each step. That is, we add the constraint $\varepsilon_r \leq P_0$ to the problem stated in (3), where P_0 is the threshold power for the largest possible value of the transmitted power from each relay. Hence, we reformulate the power optimization problem as

$$\begin{aligned} & \min_{\{\varepsilon_1, \dots, \varepsilon_R\}} \sum_{r=1}^R \varepsilon_r, \\ \text{s.t. } & \frac{C(R)}{k^{R+1}} \frac{1}{\varepsilon_s \Omega_{sd}} \prod_{r=1}^R \left(\frac{1}{\varepsilon_s \Omega_{sr}} + \frac{1}{\varepsilon_r \Omega_{rd}} \right) \leq \text{SER}, \\ & 0 \leq \varepsilon_r \leq P_0, \text{ for } r = 1, \dots, R, \end{aligned} \quad (14)$$

Although this problem is convex (due to the reasons explained in proof of Theorem 1), because of the power constraint on each relay, obtaining a closed-form solution is not possible. Thus, in the following we propose a simple algorithm to reach the optimum point in an

iterative manner. For solving this problem, we denote the set of active constraints by $\mathcal{R} = \{r \in \{1, 2, \dots, R\} \mid 0 \leq \varepsilon_r \leq P_0\}$. Thus, for those relays in \mathcal{R} , we can first use the solution derived for the problem stated in Theorem 2. In order to specify \mathcal{R} (i.e., find ε_r 's that are positive and less than P_0) we have to perform a search on λ similar to the well-known procedure for computing the capacity of parallel Gaussian channels (see, e.g., [29, page 252]).

After initializing ε_r 's, $r = 1, \dots, R$, with some small positive values, we can calculate the updated value of ε_r from (11) as a function of λ . That is $\varepsilon_r = \sqrt{\lambda} \alpha_r$, where α_r is a positive real value. Then, we use (6) and (12), and by replacing ε_r in g_r with $P_0 - (P_0 - \sqrt{\lambda} \alpha_r)^+$, we compute λ . Here $(x)^+$ denotes $(x)^+ = \max\{0, x\}$.

By repeating the procedure stated above, the optimum ε_r 's with desired accuracy is achieved. Table 1 summarizes the algorithm given above for solving (14). By observing Theorem 1, and since a set of linear constraints $\varepsilon_r \leq P_0$ are added to the problem stated in (3), the optimization problem (14) has a unique solution. This confirms that the algorithm explained in Table 1 converges to the global optimum point.

III. POWER ALLOCATION IN CONSTRAINT MULTI-BRANCH, MULTIHOP COOPERATIVE NETWORKS

In this section, we propose power control optimization problems in multi-branch, multihop networks (see Fig. 2). Here, we extend the the work done in Section II for the case that each branch has multihop transmissions.

Let us consider a cooperative system with $R + 1$ diversity branches $\{B_0, B_1, \dots, B_R\}$ as depicted in Fig. 2, where by convention the diversity branch B_0 corresponds to the direct path. Branch B_i , $i = 1, 2, \dots, R$, is composed of N_i relays $\{r_{i,1}, \dots, r_{i,N_i}\}$. The Rayleigh faded channel coefficients between the relays $r_{i,j}$ and $r_{i,j+1}$ of branch B_i are denoted by $f_{i,j}$, with $f_{i,0}$ being the channel coefficient between the source and the first relay in branch B_i and f_{i,N_i} being that between the last relay and the destination in branch B_i . Relying on the results of Subsection II-A, we are ready to obtain a power allocation of SER constrained multi-branch, multihop transmissions.

Here, without loss of generality, we are assuming the unit-variance additive noise at the destination and relays. Thus, with relay terminals operating under amplify-and-forward repetition based transmission, the system error probability (SEP) at high signal to noise ratios

that is derived in [23] can be rewritten as

$$\bar{P}_e = \frac{C(R)}{k^{R+1}} \frac{1}{\varepsilon_s \Omega_{sd}} \prod_{i=1}^R \left(\frac{1}{\varepsilon_s \Omega_{si}} + \sum_{n=1}^{N_i} \frac{1}{\varepsilon_{i,n} \Omega_{i,n}} \right), \quad (15)$$

where ε_s and $\varepsilon_{i,n}$ are the transmitted power from the source node and the n th relay in the i th branch B_i , respectively. Furthermore, $\Omega_{i,m}$ is the path-loss coefficients of the link between the relays $r_{i,m}$ and $r_{i,m+1}$ of branch B_i , with Ω_{i,N_i} being that between the last relay and the destination.

Here, we optimize the transmitted power from each relay by minimizing the total transmitted power from the relays subject to the average SER requirement at the destination. Given the knowledge of the average channel coefficients, i.e. path-loss coefficients, the optimal power allocation problem can be formulated as

$$\begin{aligned} & \min_{\varepsilon_{r,n}} \sum_{r=1}^R \sum_{n=1}^{N_r} \varepsilon_{r,n}, \\ & \text{s.t. } \frac{C(R)}{k^{R+1}} \frac{1}{\varepsilon_s \Omega_{sd}} \prod_{r=1}^R \left(\frac{1}{\varepsilon_s \Omega_{sr}} + \sum_{n=1}^{N_r} \frac{1}{\varepsilon_{r,n} \Omega_{r,n}} \right) \leq \text{SER}, \\ & \varepsilon_{r,n} \geq 0, \text{ for } n = 1, \dots, N_r, \quad r = 1, \dots, R. \end{aligned} \quad (16)$$

Before deriving the optimal solution for the problem given in (16), the following theorem is presented.

Theorem 3: The optimum power allocation $\varepsilon_{r,n}$ in the optimization problem stated in (16) is unique.

Proof: Proof of this theorem is similar to the proof of Theorem 1. ■

The SER expression in (15) can be rewritten as

$$\bar{P}_e = \frac{C(R)}{k^{R+1}} \frac{1}{\varepsilon_s \Omega_{sd}} \prod_{r=1}^R \psi_r, \quad (17)$$

where ψ_r is defined as follow

$$\psi_r = \frac{1}{\varepsilon_s \Omega_{sr}} + \sum_{n=1}^{N_r} \frac{1}{\varepsilon_{r,n} \Omega_{r,n}}. \quad (18)$$

The optimal power allocation strategy for the problem in (16) is shown in the theorem below.

Theorem 4: For the set of selected relays in the network, the optimum power allocation $\varepsilon_{r,n}$ in the optimization problem stated in (16) can be written as

$$\varepsilon_{r,n} = \frac{C(R)}{\text{SER} k^{R+1} \varepsilon_s \Omega_{sd} \Omega_{r,n} - \Omega_{r,n} C(R) \left(\frac{1}{\varepsilon_s \Omega_{sr}} + \sum_{\substack{i=1 \\ i \neq r}}^R \frac{1}{\varepsilon_{i,n} \Omega_{i,n}} \right) \prod_{\substack{i=1 \\ i \neq r}}^R \psi_r} \prod_{\substack{i=1 \\ i \neq r}}^R \psi_r \quad (19)$$

for $n = 1, \dots, N_r$, $r = 1, \dots, R$.

Proof: Similar to the procedure given in the proof of Theorem 2 to express the power control coefficients as a function of λ , we can evaluate $\varepsilon_{r,n}$ as

$$\varepsilon_{r,n}^2 = \lambda \frac{C(R)}{k^{R+1}} \frac{1}{\varepsilon_s \Omega_{sd} \Omega_{r,n}} \prod_{\substack{i=1 \\ i \neq r}}^R \psi_i, \quad (20)$$

for $r = 1, \dots, R$. Using (17) and (20), we can find λ as

$$\lambda = \frac{\varepsilon_{r,n}^2}{\text{SER}} \left(\frac{1}{\varepsilon_s \Omega_{sr}} + \sum_{\substack{i=1 \\ i \neq r}}^{N_r} \frac{1}{\varepsilon_{i,n} \Omega_{i,n}} \right). \quad (21)$$

Substituting λ from (21) into (20) we get (19). ■

In the case of relays with individual power constraint, the similar approach as the case of two-hop multi-branch cooperative network, which is discussed in Subsection II-C, can be employed. For the purpose of brevity, we avoid to explain the details. In Table 2, we present an algorithm for computing the power coefficients in an iterative manner. Note that $\beta_{r,n}$ in Table 2 is defined as

$$\beta_{r,n} = \sqrt{\frac{C(R)}{k^{R+1}} \frac{1}{\varepsilon_s \Omega_{sd} \Omega_{r,n}} \prod_{\substack{i=1 \\ i \neq r}}^R \psi_i}. \quad (22)$$

IV. POWER ALLOCATION STRATEGIES FOR NETWORK LIFETIME MAXIMIZATION

One important goal of power allocation in wireless networks is to prolong the lifetime of the battery-powered devices. The network lifetime is no longer maximized with the optimal power allocation strategy described in Section II. Therefore, we design adaptive cooperative schemes, in which after battery depletion of some of the nodes, the network could still operate. Most previous work on this subject defines the network lifetime as the time when one or several users are depleted with energy [21]. However, this definition does not accurately characterize the duration in which the network operates properly in a cooperative system. Another way of defining the lifetime of the network is when the target SER at the destination cannot be achieved with a certain probability. We consider the system consisting of R two-hop branches as shown in Fig. 1.

Two power allocation strategies, in which energy limitation of each relay is taken into account are given below.

A. Adaptive Power Maximal Residual Energy Strategy

Based on the power minimization in Section II, we will present a simple algorithm to maximize the duration for which the destination achieve the required SER.

First, all nodes are initialized by the potential transmit power equal to the source node, i.e., ε_s and the number of selected relays set to $R = N$. Then, the metrics g_{i_r} from (6) is calculated for all the non-depleted nodes in the network, where $i_r, r = 1, 2, \dots, R$ is the index of set of nodes that their residual energy is higher than the calculated transmitted power in the previous stage. Then, the optimum values of ε_{i_r} are calculated from the power allocation strategy presented in Section III. The residual battery energy of relays are represented by $E_{i_r}(n)$, $r = 1, 2, \dots, R$, where n is the time index. In fact, $E_{i_r}(n)$ denote the remaining energy of the i_r -th relay at the end of n -th data transmission. Note that, without loss of generality, the energy consumed in the transmitter circuitry is neglected. If the calculated transmitted power is less than the residual energy $E_{i_r}(n)$, the network can operate by the selected number of relays. In this manner, the required SER at the destination is fulfilled and, at the same time, the transmitted power from the energy-limited relays is minimized. If the residual energy at the i_r th relay, $E_{i_r}(n)$, becomes less than the estimated transmitted power coefficient ε_{i_r} , the depleted relay would be removed from the network. This procedure is iterated until the number of nodes which have residual energy longer than the required transmit power for achieving the given SER becomes zero. Table III shows the proposed maximal residual energy strategy to find the power control coefficients for maximizing the network lifetime.

B. Equal Power Maximal Residual Energy Strategy

In this scheme, equal power allocation across the source node and the selected relays is used. Therefore, the statistical knowledge of channel coefficients and the power allocation of other nodes are not required for computing the scaled factor of each relay. Note that, in the power allocation strategy proposed in Section II, calculating the optimum power coefficients ε_r requires the knowledge of all statistical channel information of the network as well as the updated value of the power coefficients of the other nodes. However, for increasing the network lifetime using the equal power strategy, a procedure similar to the algorithm proposed in Table I is employed. We define the h_i as

$$h_r = \frac{1}{\Omega_{sr}} + \frac{1}{\Omega_{rd}}. \quad (23)$$

Thus, the SER expression in (2) can be written as

$$\bar{P}_e = \frac{C(R)}{k^{R+1}} \frac{1}{\varepsilon_s^{R+1} \Omega_{sd}} \prod_{r=1}^R h_r. \quad (24)$$

The number of the relays is selected such that the calculated \bar{P}_e from (24) becomes less than the required SER at the destination. Table IV shows the proposed maximal residual energy strategy with equal power allocation to maximize the network lifetime.

V. SIMULATION RESULTS

In this section, the performances of the power allocation/relay selection strategies for maximizing the network lifetime are studied through Monte Carlo simulations. The AF model wireless relay network based on the repetition-based codes is considered. The transmitted symbols are modulated as BPSK. We fixed the transmitted power from the source node as ε_s . Assume that the relays and the destination have the zero-mean, unit-variance additive noise. The relays are located randomly in the network and all the corresponding links have Rayleigh flat fading with variance Ω_{pq} , where p and q are two nodes in the network. The source-to-destination link assumed to have a distance equal to 1, which implies $\Omega_{sd} = 1$. The QoS requirement for the SER at the destination is assumed to be 10^{-5} .

Fig. 3 compares the optimum power allocation scheme derived in Section II-B with the system with equal power allocation among selected relays and the source. In [24], this relay selection scheme introduced to select relays based on their positions to achieve a given SER. The number of the nodes that can be selected as relays is assumed to be $N = 14$. We assumed that d_{sr} is uniformly distributed between $1/4$ and $3/4$ in a line connecting the source to the destination, and path-loss exponent ν is equal to 2. It can be seen that the optimum power allocation scheme vastly preserve the power consumption in the network for achieving the given SER QoS at the destination. Fig. 3 demonstrates the average total transmitted power from the relays versus the transmitted power from the source. Increasing ε_s the average transmitted power from the relays decrease considerably for achieving the required SER at the destination. However, since in [24] it is assumed that the relays transmit the same value of power as the source, increasing the value of ε_s , the total transmission power from the relays increases, which is not desirable when relays have limited-energy supplies. Moreover, as it is shown in Fig. 3, at high SNR values, the number of selected relays are decreasing, which causes the well-located relays deplete fast and network becomes *dead*. Observing Fig. 3, it can also be seen that using the algorithm given in [24], the outage occurs with a ε_s

corresponding to 0 and 2 dB. That is, the equal power allocation with relay selection scheme in a network consisting of $N = 14$ nodes cannot achieve the required SER of 10^{-5} at low SNR values.

Fig. 4 compares the average consumed transmit power of each relay for different scenarios studied in Section II. We consider the the same assumptions as for Fig. 3. One can observe that by adding the upper-bound constraint on the transmit power of each relay, performance degradation in lower value of ε_s occurs for the case of $P_0 = 7\text{dB}$. Nevertheless, putting the upper-bound threshold on transmit power causes fairer distribution of power among nodes and augmenting the network lifetime. We have used the algorithm given in Table I for power-limited, minimum power scheme.

In Fig. 5, the average network lifetime with respect to the initial energy at each node is depicted versus the number of potential relays in the network. The initial battery energy of the relays is assumed to be equal, i.e., $E_r(0) = E_0$ for all r . Specifically, we take E_0 to be an integer multiple of ε_s , i.e., $E_0 = 100\varepsilon_s$. We compare the lifetime performance of adaptive power maximal residual energy strategy proposed in Subsection IV-A with minimal transmit power strategy derived in Section II for different values of ε_s . In both strategies the network lifetime increases with the number of relays due to the increased spatial diversity gain. The maximal residual energy strategy has a higher average lifetime in all cases.

We compare the lifetime performance of equal power allocation among nodes with equal power maximal residual energy strategy, which is given in Subsection IV-B, for different numbers of relays and a limited total battery energy at relays in Fig. 6. The average network lifetime of two schemes are examined for different values of ε_s . It can be seen that as ε_s decreases, it is more probable that outage occurs when the number of available potential relays (N) is small. In addition, it can be seen that using the maximal residual energy strategy with equal power allocation strategy, network lifetime increases with the number of relays. However, in the other scheme (dashed line) which allocates the equal power allocation among the selected nodes, the network would be dead if the selected well-located relays depleted.

Fig. 6 in fact is a subplot of Fig. 5, but to show more details, Fig. 6 is extracted out and shown by itself. Comparing Fig. 5 and Fig. 6 shows that using the proposed power allocation in this paper a substantial gain in term of network lifetime will be obtained comparing to equal power strategies.

In Fig. 7, we consider a multihop wireless network which takes into account the direct path from the source to the destination, as a network shown in Fig. 2. Fig. 7 shows the total

transmit power of a system described in Section III versus the number of relays for different source transmit powers and path-loss exponent ν . The required SER QoS at the destination is 10^{-3} . As it can be observed, by increasing the number of hops the total required transmit power from relays decreases. It is also obvious that as ε_s goes up, the relays can transmit less power.

VI. CONCLUSION

In this paper, we proposed power allocation strategies for AF cooperative networks that take both the statistical CSI and the residual energy information into account to prolong the network lifetime while meeting the SER QoS requirement of the destination. We derived iterative solutions for the minimum power allocation among relays in both multi-branch, two-hop and multi-branch, multihop topologies. Simulations demonstrated that the proposed minimum power allocation strategies could considerably save the total transmitted power comparing to the equal transmit power scheme. Furthermore, it is shown that using adaptive cooperative algorithms, the network lifetime increased comparing to the static cooperation schemes, in which the network could not operate after battery depletion of some of the nodes.

REFERENCES

- [1] A. Sendonaris, E. Erkip, and B. Aazhang, "User cooperation diversity. Part I. System description," *IEEE Trans. Commun.*, vol. 51, pp. 1927–1938, Nov. 2003.
- [2] J. N. Laneman, D. Tse, and G. Wornell, "Cooperative diversity in wireless networks: Efficient protocols and outage behavior," *IEEE Trans. Inform. Theory*, vol. 50, no. 12, pp. 3062–3080, Dec. 2004.
- [3] B. Maham and S. Nader-Esfahani, "Performance analysis of distributed space-time codes in amplify-and-forward mode," in *IEEE Workshop on Signal Processing Advances for Wireless Communications (SPAWC'07)*, (Helsinki, Finland), Jun. 2007.
- [4] B. Maham and A. Hjørungnes, "Power allocation in cooperative networks using differential space-time codes," in *IEEE Int. Symp. Information Theory (ISIT)*, (Nice, France), pp. 1916–1920, Jun. 2007.
- [5] B. Maham and A. Hjørungnes, "Distributed GABBA space-time codes in amplify-and-forward cooperation," in *Proc. IEEE Information Theory Workshop (ITW'07)*, (Bergen, Norway), pp. 189–193, Jul. 2007.
- [6] Y.-W. Hong, W.-J. Huang, F.-H. Chiu, and C.-C. J. Kuo, "Cooperative communications in resource-constrained wireless networks," *IEEE Signal Processing Magazine*, vol. 24, pp. 47–57, May 2007.
- [7] B. Maham and A. Hjørungnes, "Minimum power allocation in SER constrained amplify-and-forward cooperation," in *Proc. IEEE Vehicular Technology Conference (VTC 2008-Spring)*, (Singapore), pp. 2431–2435.
- [8] M. Chen, S. Serbetli, and A. Yener, "Distributed power allocation strategies for parallel relay networks," *IEEE Trans. Wireless Commun.*, vol. 7, no. 2, pp. 552–561, Feb. 2008.
- [9] A. Host-Madsen and J. Zhang, "Capacity bounds and power allocation for wireless relay channels," *IEEE Trans. Inform. Theory*, vol. 51, no. 6, pp. 2020–2040, Jun. 2005.

- [10] D. R. Brown, "Energy conserving routing in wireless adhoc networks," in *Proc. Asilomar Conf. Signals, Syst. Computers*, (Monterey, CA), Nov. 2004.
- [11] A. Reznik, S. R. Kulkarni, and S. Verdú, "Degraded gaussian multirelay channel: Capacity and optimal power allocation," *IEEE Trans. Inform. Theory*, vol. 50, no. 12, pp. 3037–3046, Dec. 2004.
- [12] M. O. Hasna and M.-S. Alouini, "Optimal power allocation for relayed transmissions over rayleigh-fading channels," *IEEE Trans. Wireless Commun.*, vol. 3, no. 6, pp. 1999–2004, Nov. 2004.
- [13] M. Dohler, A. Gkelias, and H. Aghvami, "Resource allocation for FDMA-based regenerative multihop links," *IEEE Trans. Wireless Commun.*, vol. 3, no. 6, pp. 1989–1993, Nov. 2004.
- [14] J. Luo, R. S. Blum, L. J. Cimini, L. J. Greenstein, and A. M. Haimovich, "Link-failure probabilities for practical cooperative relay networks," in *Proc. IEEE 61st Veh. Technol. Conf., Spring*, pp. 1489–1493, May 2005.
- [15] Z. Lin and E. Erkip, "Relay search algorithms for coded cooperative systems," in *Proc. IEEE Global Telecommun. Conf.*, pp. 1314–1319, Nov. 2005.
- [16] H. Zheng, Y. Zhu, C. Shen, and X. Wang, "On the effectiveness of cooperative diversity in ad hoc networks: A MAC layer study," in *IEEE Int. Conf. Acoustics, Speech, Signal Processing*, pp. 509–512, Mar. 2005.
- [17] A. Bletsas, A. Khisti, D. P. Reed, and A. Lippman, "A simple cooperative method based on network path selection," *IEEE Journal on Selected Areas in Communications*, vol. 24, pp. 659–672, Mar. 2006.
- [18] M. M. Fareed and M. Uysal, "Ber-optimized power allocation for fading relay channels," *IEEE Trans. Wireless Commun.*, vol. 7, no. 6, pp. 3339–3343, Jun. 2008.
- [19] T. Himsoon, W. P. Siriwongpairat, Z. Han, and K. J. R. Liu, "Lifetime maximization framework by cooperative nodes and relay deployment in wireless networks," *IEEE Journal on Selected Areas in Communications (JSAC)*, vol. 25, pp. 306–317, Feb. 2007.
- [20] Z. Han and H. V. Poor, "Lifetime improvement in wireless sensor networks via collaborative beamforming and cooperative transmission," *IEE Proceedings of Microwaves, Antennas and Propagation, Special Issue on Antenna Systems and Propagation for Future Wireless Communications*, vol. 1, pp. 1103–1110, Dec. 2007.
- [21] Y. Chen and Q. Zhao, "Maximizing the lifetime of sensor network using local information on channel state and residual energy," in *Proceedings of the Conference on Information Science and Systems (CISS)*, Mar. 2005.
- [22] W. Huang, Y. Hong, and C. J. Kuo, "Lifetime maximization for amplify-and-forward cooperative networks," in *Proc. IEEE Wireless Communications and Networking Conference (WCNC)*, (Hong Kong, China), 2007.
- [23] A. Ribeiro, A. Cai, and G. B. Giannakis, "Symbol error probability for general cooperative links," *IEEE Trans. Wireless Commun.*, vol. 4, pp. 1264–1273, May 2005.
- [24] J. Vazifehdan and H. Shafiee, "Optimal configuration of wireless cooperative networks," in *Conference on Wireless and Optical Communications Networks/IFIP*, (Dubai, United Arab Emirates), Mar. 2005.
- [25] Q. Wang, G. Takahara, H. Hassanein, and K. Xu, "On relay node placement and locally optimal traffic allocation in heterogeneous wireless sensor networks," in *IEEE Conference on Local Computer Networks (LCN'05)*, 2005.
- [26] S. Vakil and B. Liang, "Balancing cooperation and interference in wireless sensor networks," in *Proc. IEEE SECON*, Jun. 2006.
- [27] A. Ribeiro, A. Cai, and G. B. Giannakis, "Symbol error probability for general cooperative links," in *Proc. Int. Conf. on Communications*, (Paris, France), Mar. 2004.
- [28] S. Boyd and L. Vandenberghe, *Convex Optimization*. Cambridge: Cambridge Univ. Press, 2004.
- [29] T. M. Cover and J. Thomas, *Elements of Information Theory*. New York: John Wiley and Sons, Inc., 1991.

TABLE I

MINIMUM POWER SER CONSTRAINT STRATEGY WITH LIMITED-ENERGY RELAYS

Initialize ε_r , $r = 1, \dots, R$, with some small positive values.

Recursion:

Calculate ε_r form (11) as a function of λ .

Find λ using (12), and by replacing ε_r in g_r with $P_0 - (P_0 - \sqrt{\lambda}\alpha_r)^+$.

Repeat the recursion until the desired accuracy is reached.

TABLE II

MINIMUM POWER SER CONSTRAINT STRATEGY WITH LIMITED-ENERGY RELAYS IN MULTIHOP, MULTI-BRANCH

COOPERATIVE NETWORK

Initialize $\varepsilon_{r,n}$, $n = 1, \dots, N_r$, $r = 1, \dots, R$, with some small positive values.

Recursion:

Calculate ε_r form (20) as a function of λ .

Find λ using (17), and by replacing $\varepsilon_{r,n}$ in ψ_r with $P_0 - (P_0 - \sqrt{\lambda}\beta_{r,n})^+$ and by replacing \bar{P}_e with the QoS requirement SER.

Repeat the recursion until the desired accuracy is reached.

TABLE III

ADAPTIVE POWER MAXIMAL RESIDUAL ENERGY STRATEGY

Initialization:

$$R = N, n = 1,$$

$$\varepsilon_i = \varepsilon_s, \text{ for } i = 1, \dots, N$$

Recursion 1:

Calculate g_{i_r} , $r = 1, \dots, R$

Calculate the optimum values of ε_{i_r} from (7)

if $\varepsilon_{i_r} \leq E_{i_r}(n)$ for all $r = 1, \dots, R$

Recursion 2

$n = n + 1$; transmit data

$$E_{i_r}(n) = E_{i_r}(n - 1) - \varepsilon_{i_r}, \text{ for } r = 1, \dots, R$$

if $\varepsilon_{i_r} > E_{i_r}(n)$ for some $r = 1, \dots, R$

stop *Recursion 2*

Remove nodes with $\varepsilon_{i_r} > E_{i_r}(n)$

$R = R - \text{number of removed nodes}$

if $R \leq 0$

stop *Recursion 1*

TABLE IV

EQUAL POWER MAXIMAL RESIDUAL ENERGY STRATEGY

Initialization:

$$R = 1, n = 1,$$

$$\varepsilon_i = \varepsilon_s, \text{ for } i = 1, \dots, N$$

*Recursion 1:*Calculate $h_i, i = 1, \dots, N$ Select R terminals that have lowest value of h_i Sort all h_r such that $h_1 < h_2 < \dots < h_R$ if $C(R)/((\varepsilon_s k)^{R+1} \Omega_{sd}) \prod_{r=1}^R h_r < \text{SER}$ if $\varepsilon_s < E_r(n)$ for all $r = 1, \dots, R$ *Recursion 2* $n = n + 1$; transmit data

$$E_r(n) = E_r(n - 1) - \varepsilon_s, \text{ for } r = 1, \dots, R$$

if $\varepsilon_s > E_r(n)$ for some $r = 1, \dots, R$

Remove depleted nodes

 $N = N - \text{number of depleted nodes}$ stop *Recursion 2*

$$R = R + 1$$

if $R > N$ stop *Recursion 1*

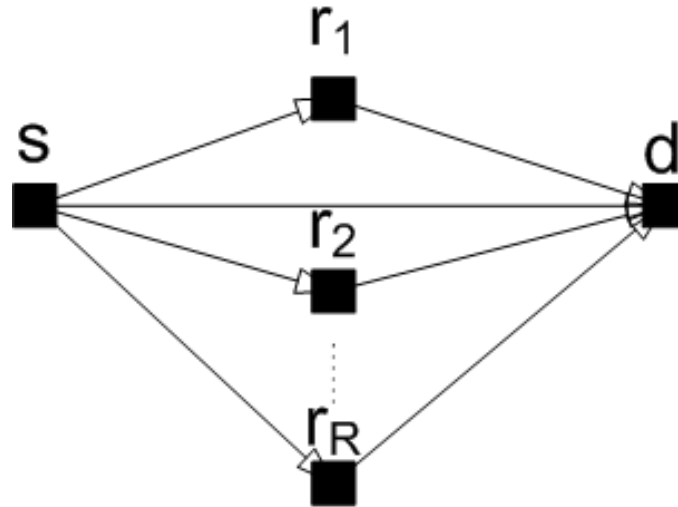
Fig. 1. Wireless relay network consisting of a source s , a destination d , and R relays.

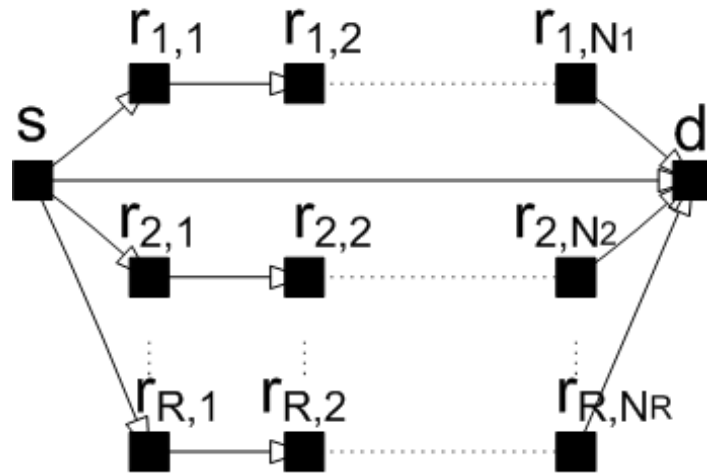

Fig. 2. Wireless relay network with multihop, multi-branch transmission.

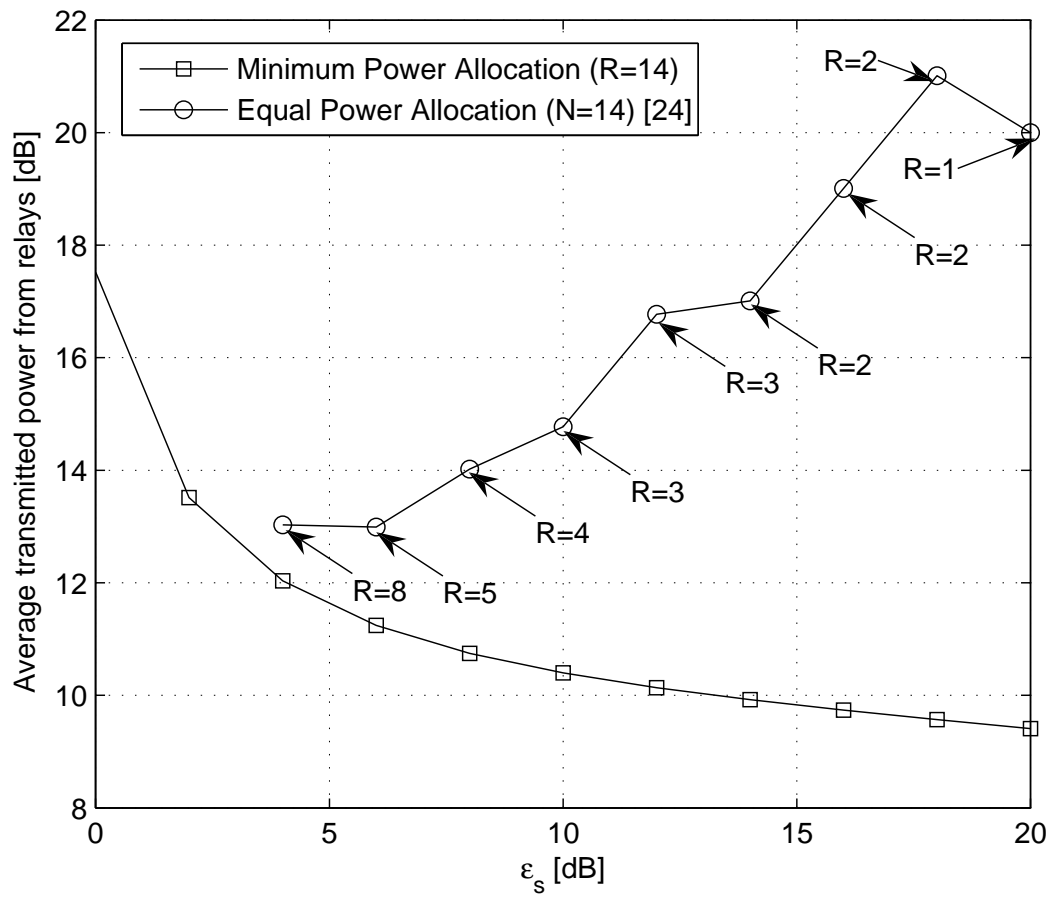

Fig. 3. Performance comparison of the optimal power allocation and equally power allocation in a network with $N = 14$ potential relays and SER constraint of 10^{-5} .

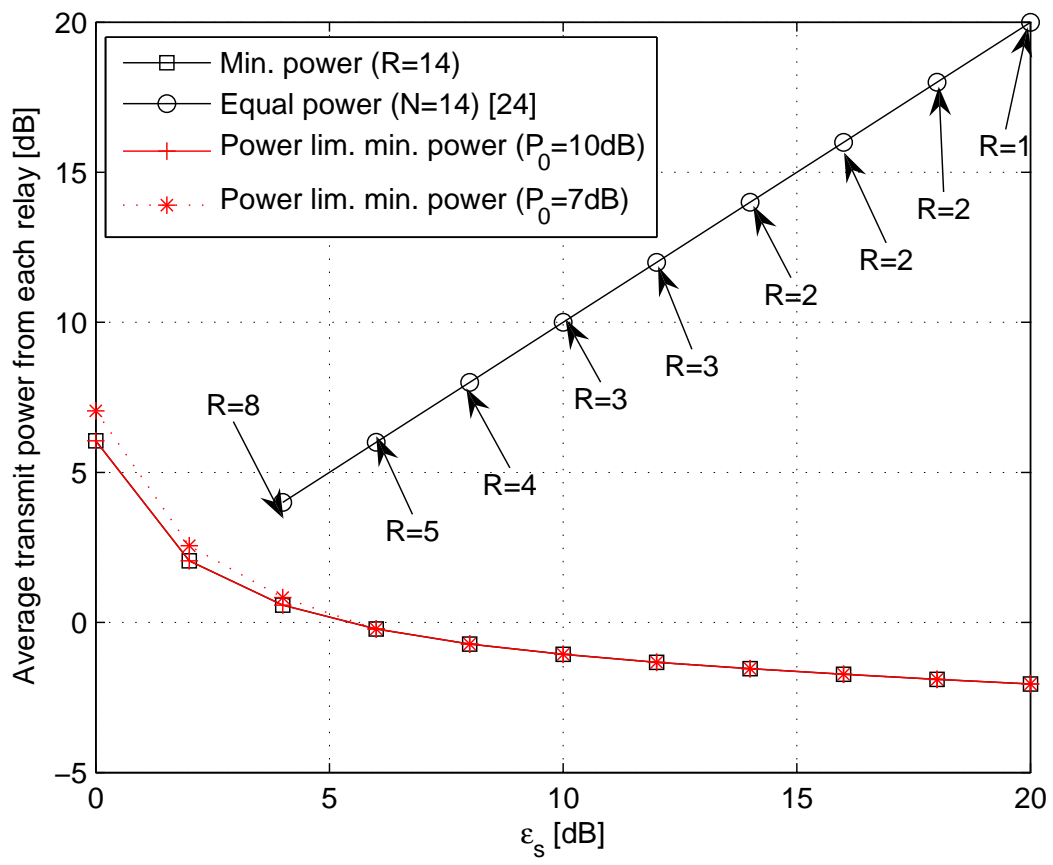

Fig. 4. Performance comparison of the optimal power allocation and equally power allocation in a network with $N = 14$ potential relays and SER constraint of 10^{-5} .

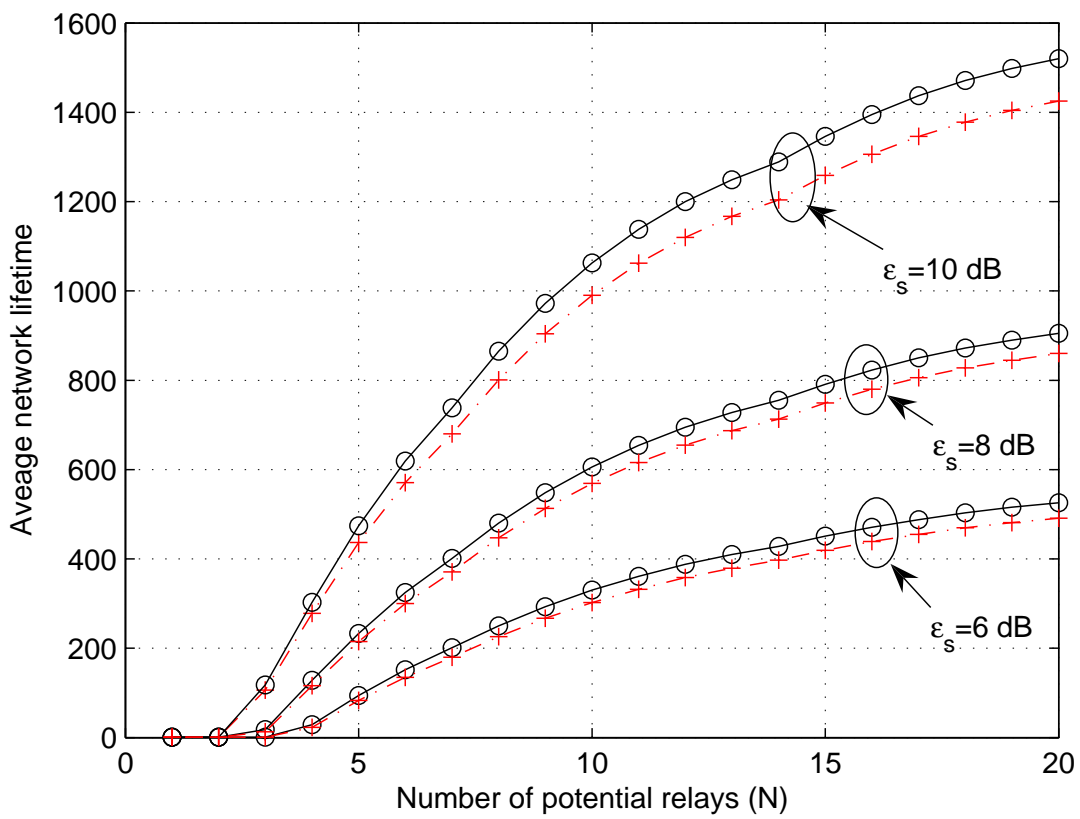

Fig. 5. The lifetime performance of minimal transmit power strategy with adaptive power maximal residual energy strategy, when SER constraint is 10^{-5} . The minimal transmit power strategy and adaptive power maximal residual energy strategy are corresponding to the dashed lines and solid lines, respectively.

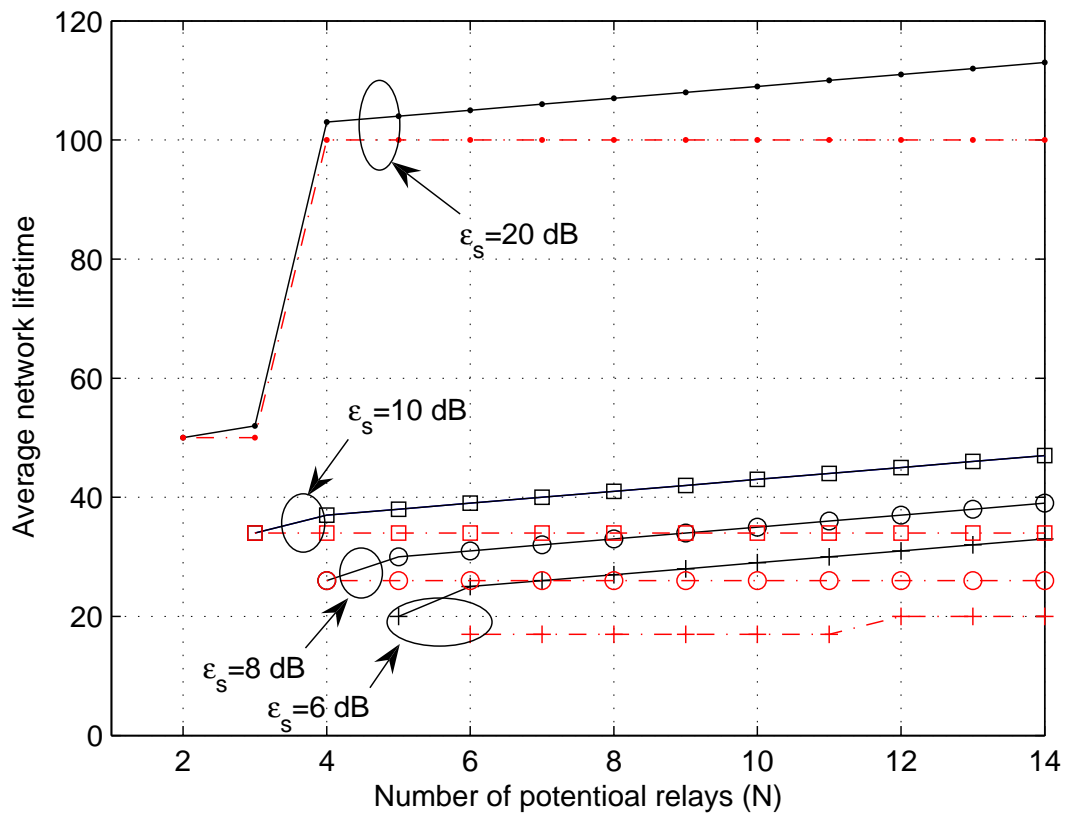

Fig. 6. The lifetime performance of equal power allocation among the selected nodes (dashed red lines) with equal power maximal residual energy strategy (solid black lines), when SER constraint is 10^{-5} .

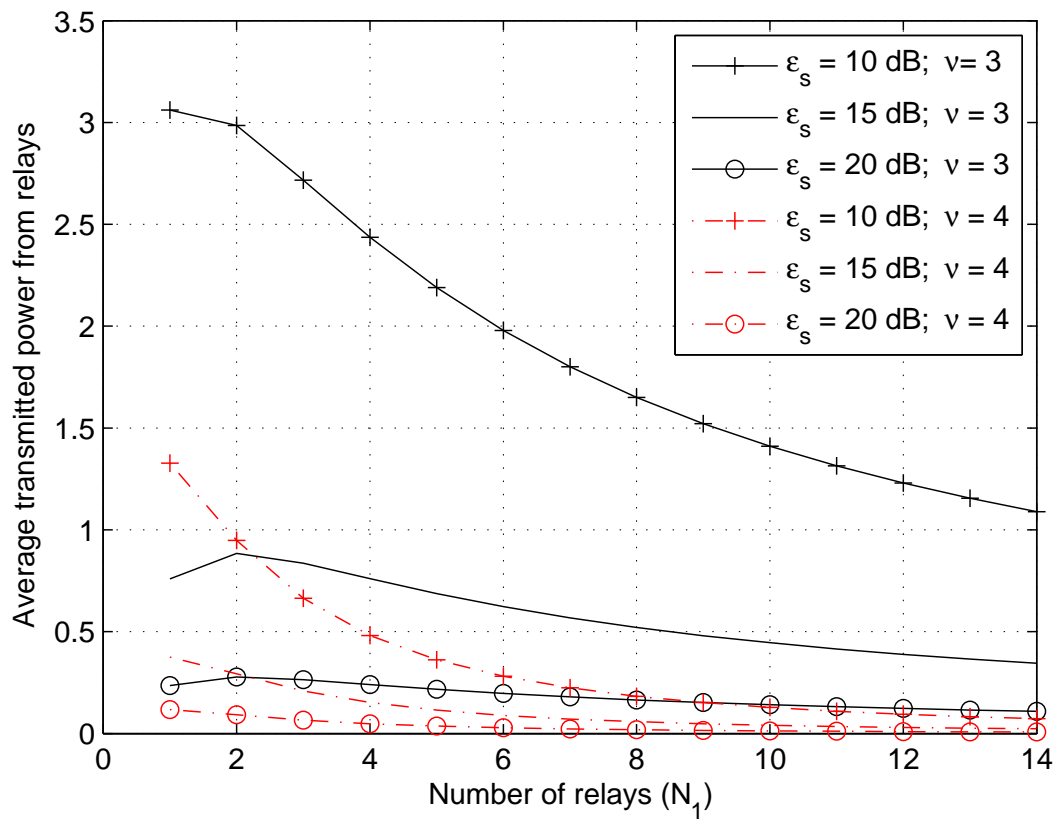

Fig. 7. Total transmit power of a multihop wireless network consisting of a direct path B_0 and a branch with N_1 cascaded relays, and $\text{SER} = 10^{-3}$.