



HAL
open science

Supercapacitors for Power Assistance in Hybrid Power Source with Fuel Cell

Toufik Azib, Olivier Bethoux, Claude Marchand, Eric Berthelot

► To cite this version:

Toufik Azib, Olivier Bethoux, Claude Marchand, Eric Berthelot. Supercapacitors for Power Assistance in Hybrid Power Source with Fuel Cell. IEEE-IECON 2009, the 35th Annual Conference of the IEEE Industrial Electronics Society, Nov 2009, Porto, Portugal. pp.11-18, <10.1109/IECON.2009.5415129>. <hal-00447272>

HAL Id: hal-00447272

<https://centralesupelec.hal.science/hal-00447272v1>

Submitted on 2 May 2025

HAL is a multi-disciplinary open access archive for the deposit and dissemination of scientific research documents, whether they are published or not. The documents may come from teaching and research institutions in France or abroad, or from public or private research centers.

L'archive ouverte pluridisciplinaire HAL, est destinée au dépôt et à la diffusion de documents scientifiques de niveau recherche, publiés ou non, émanant des établissements d'enseignement et de recherche français ou étrangers, des laboratoires publics ou privés.



Distributed under a Creative Commons CC BY-NC 4.0 - Attribution - Non-commercial use - International License

Supercapacitors for Power Assistance in Hybrid Power Source with Fuel Cell

T. Azib, O. Bethoux, *Member, IEEE*, C. Marchand, *Member, IEEE*, and E. Berthelot,
Laboratoire de Génie Electrique de Paris (LGEP) / SPEE-Labs, CNRS UMR 8507,
SUPELEC ; Université Paris Sud VI (UPS11) ; Université Pierre Marie Curie (UPMC).
Plateau de Moulon, 91192 Gif-sur-Yvette cedex,
toufik.azib@lgep.supelec.fr

Abstract- This paper deals with the use of supercapacitors as ancillary power supply in transport applications powered by a PEM fuel cell. These applications are known for strong transient power demand which makes supercapacitors a relevant choice. The aim of this association and its associated power management is to guarantee load requirements as well as to minimize fuel consumption and to ensure that each component constraint is satisfied (lifetime, reliability, high efficiency, ...). The designed strategy uses a cascade control allowing a frequency decomposition of the power demand cycle: supercapacitors supply the high band of the load power frequency spectrum whereas low frequencies are provided by the fuel cell which contributes to the long-term autonomy.

An experimental 1 kW power test bench has been designed to illustrate the effectiveness of the proposed method. Experimental results are presented demonstrating that this approach provides improvements in terms of a significant energy savings when ancillary power supply is implemented.

I. INTRODUCTION

In the last years, research results have demonstrated that the use of the energy storage devices provides additional advantages to a power supply source such as fuel cell (FC). It improves energy efficiency, power quality, stability and reliability. At the present time, these auxiliary devices can be either batteries or supercapacitors (SCs). In comparison to standard batteries, SCs benefit from good energy effectiveness, large specific power value and high lifetime (superior than one million cycles). Moreover, their energy density is compatible with power requirements of a large range of applications, such as electric vehicles, portable, electronic devices, or spacecraft power systems, which have a common characteristic in their load profiles. As a matter of fact, these loads demand high instantaneous power during short periods of time. Another advantage of the SCs consists in operating even at low temperatures (e.g. $-20\text{ }^{\circ}\text{C}$) and in severe thermal constraints [1], [2].

In the meantime, fuel cells (FC) (e.g. PEM fuel cells for these applications) are considered to be the most promising alternatives among next generation energy devices due to their high energy density and their clean energy properties [3], [4]. However, in order to obtain good efficiency conversion as well as long life time, the FC system must be well monitored in order to respect FC inherent characteristics.

As a matter of fact, FC system is very sensitive to the stack state health. For instance, membrane flooding or drying, gases channels drowning as well as reactive concentration drop involve a high voltage drop and hence a poor efficiency (especially at high power). In addition, FC system has poor time response to instantaneous power demands, due to the low time response of the air delivery system. Consequently, erratic load requirement may lead to fuel cell starvation phenomena or voltage drop during short times which significantly raises aging effects [5-8]. This problem can be solved by anticipation of transient power peak. For this purpose, the idea is to combine FC with a fast power supply such as SCs, carrying out a hybrid power source. This solution is attractive since it makes it possible to meet the load specifications with both high power and high energy densities. In such a hybrid FC/SCs power source, the fuel cell is controlled to satisfy load average power requirements over a long term period; whereas the transient power requirement, involving important exchanges of power in short time intervals, are ensured by the SCs. This structure guarantees the best use of the advantages of each individual device. It nevertheless needs a power electronics interface in order to adapt the disparate voltage levels of different power elements (FC, SCs, and Load). This power interface must also be supervised by an energy management controller in order to ensure a safe use of each device.

This work presents the structure which consists in using SCs as FC power assistance. The hybrid source control strategy principle is depicted. Our main concern is to evaluate the improvement achieved by using a SCs bank. For this purpose we compare a unique FC power supply with a hybrid FC/SCs source on the same load profile. Experimental results are analysed. Our interest is focussed on the stability of the system, on the energy flux management, as well as on the hydrogen consumption, which is the primary energy source.

II. HYBRID POWER SYSTEM DESCRIPTION AND LOAD REQUIREMENTS

A. System Description

The structure presented in Fig. 1 consists in associating a static converter with its control device to every source. The converter dedicated to the FC is unidirectional in power and works in boost mode. The converter connected to the SCs works in boost mode when SCs deliver a part of the power

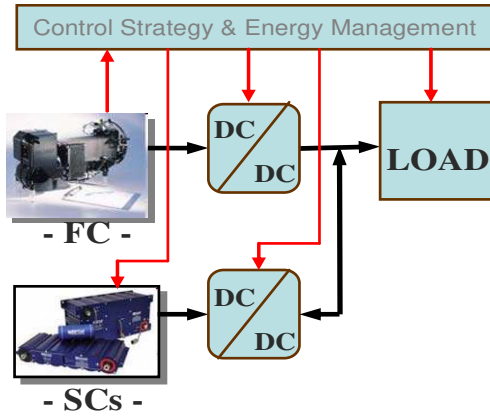

Fig. 1. Block diagram of a hybrid power system.

demand, and operates in buck mode when SCs get back the recovering energy. Thus, static converters (“choppers”) and their control devices coordinate the two energy sources, so as to meet the electric load requirement. It is the simplest structure to implement and each power source can be monitored very precisely. This hybrid structure has been validated in various works and for different applications [9-11].

Within this hybrid system (Fig. 1) several modes of operation can be identified. These modes of functioning (normal, discharge and recovery) are characterized by different energy streams. We describe them briefly:

--Normal mode. The main source not only supplies the necessary energy to the electric load, but also pre-charges the auxiliary source to its reference voltage level so as to enable the system to be ready for any sudden impulse power demand.

--Discharge mode. Both of the energy sources simultaneously supply the required energy to the electric load so as to create the desired energy for an impulse request.

--Recovery mode. The electric load operates as generator, so that the energy flows back to the hybrid power source. SCs level of charge increases because of this energy flow and because the main source power drops slowly.

B. Load Requirements

In many applications the power demand is impulsive rather than constant. For example, driving cycles have been normalized in vehicle test purpose. European light duty vehicles have to face the New European Driving Cycle (NEDC) which represents the typical usage of a car in Europe. The NEDC (Fig. 2) consists of repeated urban cycles (called ECE-15 driving cycle) and an Extra-Urban driving cycle, or EUDC. On the power demand value, one can notice sudden power changes each time the driver requires a speed change. On that ECE-15 cycle, the car average power demand is only 0.72 kW whereas the peak power is roughly 10 kW which means a 13.7 ($P_{max}/P_{average}$) ratio.

For those reasons, our control strategy will be tested with a severe profile consisting of a power rise hedge.

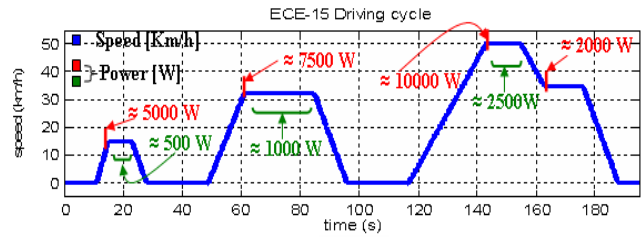

Fig. 2. ECE-15 driving cycle.

III. CONTROL STRATEGY OF HYBRID POWER SOURCE

This strategy must allow the hybrid power system to satisfy load power specifications while, on the one hand minimizing the fuel consumption and on the other hand assuring the integrity of each component. To face this challenge, it is a basic necessity to monitor the storage energy source state of charge. In steady state, it must indeed be neither too low nor too high in order to have good response in both discharge mode and recovery mode.

Different control strategies have been proposed to manage the energy in a hybrid system [9-17] for different applications. In some papers [13-15], strategies based on the evolution of the state of the system, with separate control algorithms are proposed to control the system when the operating mode changes due to load power variation. Therefore, to move from an operating mode to another one, it is necessary to switch from one control algorithm to another one. This can result in a high instantaneous current requirement to the main source.

Conversely, the proposed control strategy is based on the regulation of the DC link voltage [9], [15], [16]. Indeed, this strategy uses a cascade system allowing a frequency decomposition of the power demand cycle [17] which allows eliminating the mentioned problem. To implement this strategy, the energy management consists in building each source power set-point according to its inherent properties (Fig. 3). As SCs are able to provide high positive or negative impulse powers, they can supply or absorb the highest part of the load power frequency spectrum and also huge power peak. Low frequencies are delivered by the fuel cell since FC associated with its hydrogen tank is the unique source which can contribute to the long-term autonomy.

Fig. 4 shows the main control-command functional blocks while the management strategy is described in the following paragraph.

The idea is to drive the current of each source by the means of an inner current loop controlling each PWM’s chopper.

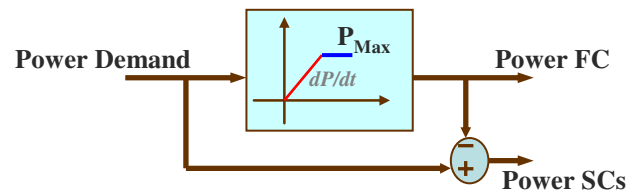

Fig. 3. Power Management Principle

Indeed, monitoring this current is essential in order to protect the chopper (as well as the sources SCs and FC) against breaking over-currents. The controller unit has to compute each converter current set-point. Hence, we can design a classical PI regulator and implement it with an anti-windup compensator so as to take the duty cycle range into account ($0 < \alpha < 1$). In the case of an unknown load, each load power change modifies the bus voltage. Hence its measurement is essential for the supervisor. So, the outer loop associated to the SCs management has to monitor the bus voltage and to ensure a constant value of the bus voltage V_{BUSref} (set at 48 V). The faster of this voltage tracking is, the smaller the C_{BUS} capacitance value is.

The supercapacitor bank is able to deliver a large power during a short time as long as its state of charge remains acceptable ($V_{nom} / 2 < V_{SC} < V_{nom}$). Therefore, bus voltage perturbations are taken into account by the SCs current. But this power reaction leads to a slow change of SCs state of charge. The auxiliary power state of charge is monitored by the main supply. It should ideally remain such as the amount of energy it can collect $+\Delta E_{SC}$ is equal to the one it can restore $-\Delta E_{SC}$. By slowly changing the fuel cell current, the storage voltage $V_{SC}(t)$ can subsequently go back to its optimal value $V_{SCref}(t)$ defined as follows:

$$V_{SCref} = V_{NOM} \cdot \sqrt{\frac{5}{8}} = 0,79 \cdot V_{NOM} \quad (1)$$

$$|\Delta E_{SC}| = \frac{3}{16} \cdot C_{SC} \cdot (V_{NOM})^2 \quad (2)$$

In the case of a well-known load demand (which might be the case in a driving system), a feed-forward loop can be added to the SCs current set-point.

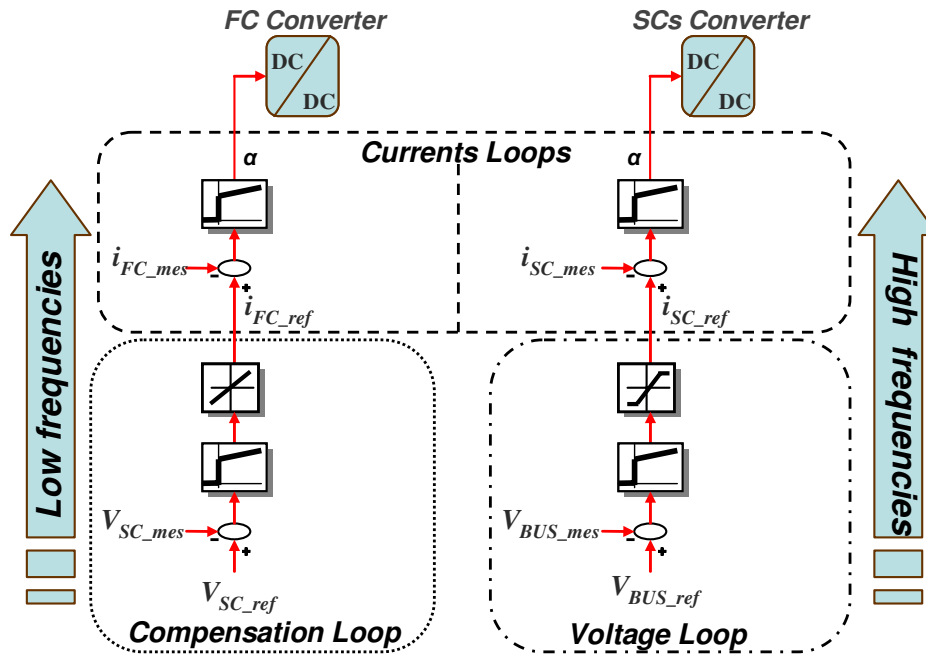

Fig. 4. Block diagram of control-command management strategy

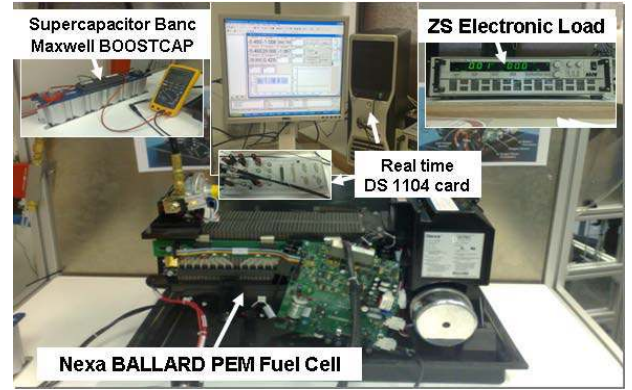

Fig. 5. Photograph of test bench.

To respect dynamics decoupling, the management part dedicated to the FC must have a time response ten times larger than the previous one. This second part also includes two imbricate loops : the inner one is a current loop (as described above) whereas the outer one is a PI corrector including an anti-windup compensator to carefully deal with the $i_{SC_ref}(t)$ and $i_{FC_ref}(t)$ command ranges limited to operate in safe conditions:

$$i_{SC_min}(t) \leq i_{SC}(t) \leq i_{SC_max}(t) \quad (3)$$

$$0 \leq i_{FC}(t) \leq i_{FC_max}(t) \quad (4)$$

With this imbricate control structure, we pointed out that, this structure is a very simple to implement. It fulfils the hybrid system requirements: the load requirement and the components constraints.

IV. EXPERIMENTAL RESULTS

A. Test bench Description

Fig. 5 shows photography of the hybrid system test bench that has been implemented to validate the proposed control strategy. It was built using Nexa BALLARD PEM fuel cell stack (1200 W rated power), to Maxwell SC modules associated in series (every module is achieved with a series connection of six individual “2.7 V, 1.5 kF” elements), two DC/DC power converters realized with standard IGBT modules (SEMIKRON: SKM50GB123D), a ZS electronic load ZS1806 of 1800 W and a real-time dSPACE DS1104 controller board. The energy management control strategy is designed using Matlab/Simulink and then implemented on this controller board.

Table 1 shows the electric characteristics of the hybrid system.

TABLE I
ELECTRIC CHARACTERISTICS OF HYBRID SYSTEM

Fuel Cell: Parameter Name	Value
Open circuit voltage	45 V
Rated voltage	26 V
Rated current	46 A
Supercapacitors: Parameter Name	Value
Capacitance	125 F
Rated Voltage	30 V
Rated Current	200 A
Optimal Voltage (V_{SCref})	24 V
Electronic Load : Parameter Name	Value
Rated Power	1800 W
Rated Current	150 A
Rated Voltage	60 V
Inductors & Capacities : Parameter Name	Value
Inductor L_1	200 μ H
Inductor L_2	100 μ H
Rated Current L_1	100 A
Rated Current L_2	150 A
Capacities C_{BUS}	14 mF
Optimal DCBus Volatge (V_{BUSref})	48 V

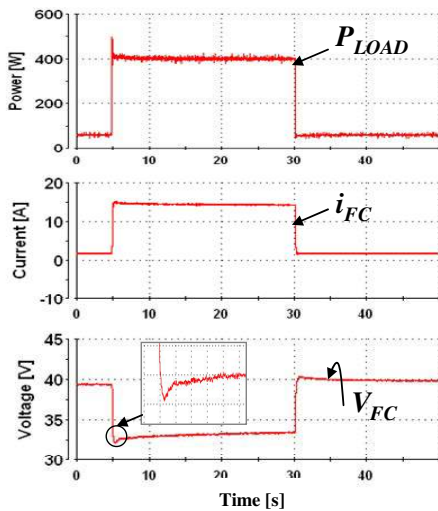

Fig. 6. Response of FC system

The control loops, which generate $i_{SC,ref}$ and $i_{FC,ref}$ current references, have been implemented with digital PI controllers, while measurements come to the dSPACE controller board through the A/D converters operating with sample frequency equal to 25 kHz.

B. Analysis of results

Some experiments have been carried out with the test bench in order to check the obtained theoretical results. At first, the investigation will be focused on the transient response of both the FC alone and FC assisted by SCs. It consists in a sequence of two fast load variations from 50 W to 400 W and from 400 W to 50 W as reported in Fig. 6 and 7. Fig. 6 represents the fuel cell response of the unique source system, while Fig. 7 shows the fuel cell and the SCs responses in the hybrid source context. In the first case, a strong $V_{FC}(t)$ voltage drop can be observed on the FC voltage. This overshoot is synchronized with FC current rising hedge ($i_{FC}(t)$). It occurs during a few seconds and is indicative of a reactants concentrations fall due to slow compressor reaction time. On the back of $V_{FC}(t)$ curve, we zoom on the decreasing part of the FC voltage. Indeed, this functioning mode (without assistance) implies that fuel cell has difficulties to follow the power step which implies that this power structure has to cope with important performance degradations leading to a fuel cell lifetime shortening [6], [7]. Conversely, the FC/SCs hybrid system response (Fig. 7) shows that FC voltage ($V_{FC}(t)$) is not subjected to any sudden drop which is related to a smooth FC current behaviour ($i_{FC}(t)$). After each load power hedge, this current rises or falls in several seconds. On the contrary, the SCs current ($i_{SC}(t)$) is characterized by current hedges in order to compensate the lacking power. Then, after a while (a few seconds), the FC is able to rebalance the SCs and drives it to its voltage reference value which was fixed at 24 V ($V_{SCref}(t)$): SCs current value finally becomes zero. Similarly the sudden decrease of load power induces a smoothly increase of FC voltage involving a slowly decrease of FC current and this energy is not lost but

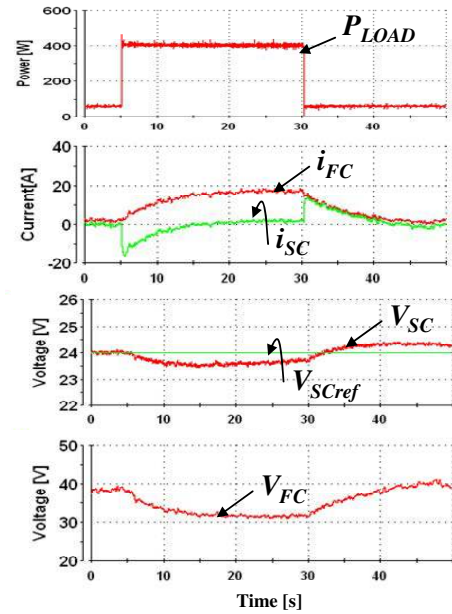

Fig. 7. Response of FC/ SCs system

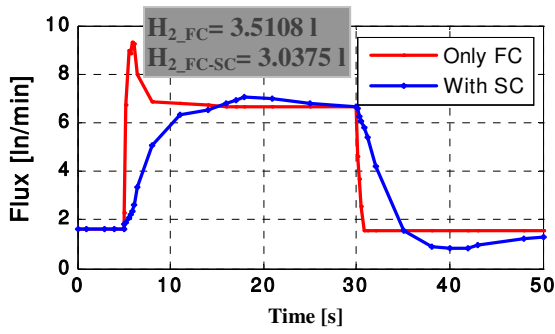

Fig. 8. Hydrogen mass flow consumption.

recovered by SCs.

As mentioned before, another very important concern is the energy efficient leading to fuel savings. That is the reason why we also analyse both systems (FC and FC/SCs) in terms of hydrogen consumption. Fig. 8 shows the hydrogen mass flow and actual H_2 volume consumption of each system following the same load profile. For FC acting as the unique source of power, an overshoot occurs at each load power increase. This has to be related to the stack behaviour (voltage drop) as well as the system behaviour. As a matter of fact, this sudden current change implies a huge and fast reactants flow variation. From the air side point of view, this means that the air compressor speed must change very quickly which requires high transient auxiliary power in order to increase the air flow as well as the engine kinetic energy. This high transient auxiliary power is fed by the fuel cell: many losses occur in auxiliary devices as well as in the stack which operates with poor efficiency at

high power rate (especially in transient mode). Conversely, the use of the assistance source (SCs) allows limiting the dynamics of the FC system. Consequently, during fast transients, this architecture leads both to a better stack operating conditions and to a smooth power change in auxiliary devices. Hence, during power demand increase there is no fuel (hydrogen) overconsumption. We must point out that, during power demand decrease, fuel cell system also falls slowly down. But this is not a drawback since the SCs are able to store the H_2 energy converted by the fuel cell. On Fig. 8, one can check that the FC/SCs architecture leads to a global volume fuel consumption reduction ($\approx 13\%$) compared to FC architecture.

A further verification (Fig. 9) of FC/SCs dynamic behaviours was carried out. The test was conducted on a power cycle representative of the mission of a great number of applications, like vehicles (see load requirements section). It can be observed on the supercapacitors current ($i_{SC}(t)$) that the compensation action is very effective according to the dynamic variation of power demand (Fig. 9). Whatever the power demand, the control supervision part immediately reacts by modifying the SCs current reference ($i_{SCref}(t)$). This fact confirms the performance of the fast internal current loop as well as the outer loop of the SCs management. The DC Bus voltage is slightly affected by the power load fluctuation. But clearly, control supervision can perfectly regulate it at its reference value ($V_{BUSref} = 48$ V), which proves the effectiveness of the regulation voltage loop.

At the same times, SCs voltage ($V_{SC}(t)$) varies but the FC current and voltage ($i_{FC}(t)$, $V_{FC}(t)$) are not subject to any sudden changes. After each power step, the FC tends to set the SCs bank to its

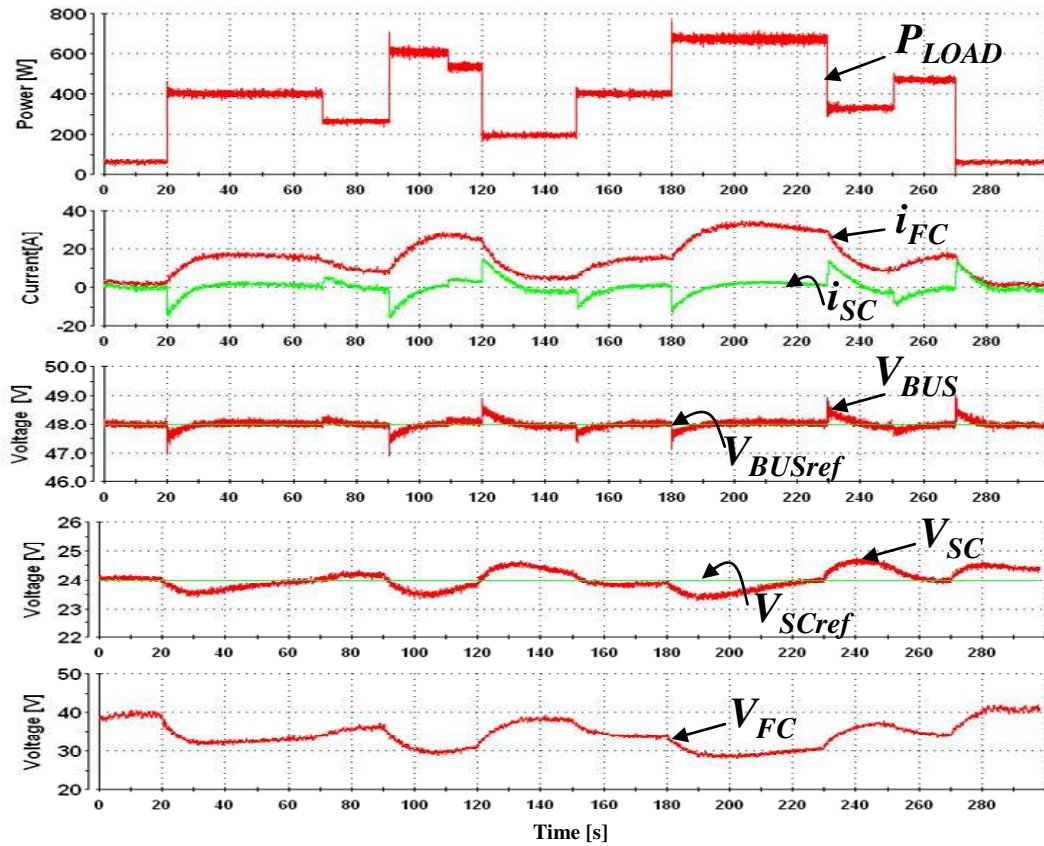

Fig. 9. Response of FC/SCs system for a complete load.

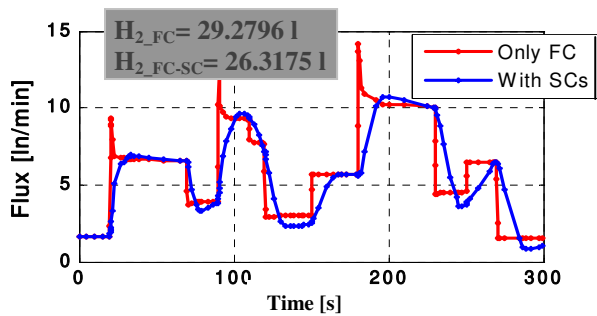

Fig. 10. Hydrogen mass flow consumption.

nominal state of charge by driving its voltage to its reference value ($V_{SCref}(t)$): in steady state conditions, the global system rebalances.

Note that for each power load decrease, SCs current sign changes in order to absorb over energy from the DC bus, as well as electrical energy produce by fuel cell, inducing the increase of the SCs state. The obtained results in this operation illustrate the performance of the compensation loop.

As a final test, Fig. 10 represents a comparative hydrogen consumption and actual H_2 volume consumption of FC system and FC/SCs hybrid system. It clearly shows that hydrogen use is enhanced thanks to SCs ($\approx 10\%$ of volume reduction). Indeed, during power demand peaks, there is no overconsumption which is not the case of the system using FC as unique power source.

In conclusion, this study outlines that the SCs use allows building an effective and relevant hybrid power system both in terms of FC lifetime and in terms of fuel savings.

V. CONCLUSION

In this paper, we study the advantages of implementing a hybrid power source made of a fuel cell sustained by supercapacitors. A control strategy is developed for this specific architecture. This strategy can well manage energy flux meeting load requirements as well as power sources limits. In particular slow fuel cell dynamics are taken into account leading to an important stress reduction which induces better efficiency and better aging process. To prove this, comparisons are carried out with the same load profile between a single source (FC alone) and a hybrid source (FC/SCs). Experimental results clearly show that the performance of the FC system is improved by sustaining the FC with SCs, especially in the following aspects: FC lifetime and power supply efficiency.

- SCs improve the fuel cell working conditions. Its current waveform is smoothed due to the anticipation of the supercapacitors, which increases its operating life.

- SCs reduce the fuel consumption. As a matter of fact, SCs allows a continuous functioning of the FC and enforces the FC to remain close to its most efficient power point. Hence, SCs prevent against overconsumption when peak power demand occurs. Conversely when supplying the load with FC as unique power source, each power increase involves a huge transient H_2 consumption due to FC auxiliary systems and to bad-adapted stack conditions. Moreover, fuel

cell system also falls slowly and SCs store the H_2 energy converted instead of wasting it.

It is important to highlight that the experimental test bench results can be scaled to larger or smaller power values and are typical of fast transient applications.

REFERENCES

- [1] P. Barrade, A. Rufer, "The use of supercapacitors for energy storage in traction systems", *IEEE, Vehicular Power and Propulsion Symposium, VPP'04*, 6-8 Oct.2004.
- [2] V.A. Shah, J. A. Joshi, R. Maheshwari and R. Roy, "Review of Ultracapacitor Technology and its Applications", *Fifteenth National Power Systems Conference (NPSC), IIT Bombay*, Dec. 2008.
- [3] M. Ehsani, Y. Gao, S.E. Gay, and A. Emadi, "Modern Electric, Hybrid Electric, and Fuel Cell Vehicles Fundamentals, Theory, and Design", *CRC Press*, 2005, ISBN: 0849331544.
- [4] P. Fontela, A. Soria, and all, "Airport electric vehicle powered by fuel cell", *Elsevier, Journal of Power Sources*, Vol. 169, 2007, pp.184-193
- [5] F.N. Büchi, M. Inaba, and T.J. Schmidt, "Polymer Electrolyte Fuel Cell Durability", *Springer*, Feb. 2009, ISBN: 0387855343.
- [6] F. Harel, X. François, D. Candusso, M-C. Péra, D.Hissel, and J-M. Kauffmann, "PEMFC durability test under specific dynamical current solicitation linked to vehicle road cycle," *Fuel Cells from Fundamentals to Systems, Wiley-VCH*, Vol. 7, Issue 2, April 2007, pp 142-152.
- [7] S.D. Knights, K. M. Colbow, J. St-Pierre, and D.P. Wilkinson, "Aging mechanisms and lifetime of PEFC and DMFC", *Journal of Power Sources*, Vol.127, 2004, pp. 127-134.
- [8] M.Gerardd, J-P. Poirot-Crouvezier, P. Schott, A.A. Franco, "PEMFC fuel cell/system interaction: analysis of the stack condition to minimize the oxygen starvation and impact on the fuel cell degradation performance", *Fundamentals and Developments of Fuel Cells Conference, FDFC2008*, Nancy, France.
- [9] P. Thounthong, S. Raël, and B. Davat, "Control strategy of fuel cell and supercapacitors association for distributed generation system," *IEEE, Transactions on Industrial Electronics*, Vol. 54, No. 6, Dec. 2008.
- [10] Becherif, M Y Ayad, and A Miraoui, "Modeling and Passivity-based Control of Hybrid Sources: Fuel Cells and Super-Capacitors," *Industry Applications Conference, IEEE-IAS'06*, 2006, pp.1134 - 1139.
- [11] A. Hajizadeh, M. A. Golkar, "Intelligent power management strategy of hybrid distributed generation system", *Elsevier, Electrical Power and Energy Systems*, Vol.29, 2007, pp.783-795
- [12] P. Fontela, A. Soria, and all, "Airport electric vehicle powered by fuel cell", *Elsevier, Journal of Power Sources*, Vol. 169, 2007, pp.184-193.
- [13] S. Caux, J. Lachaize, M. Fadel, P. Shott, L. Nicod, "Modelling and control of a Fuel Cell System and Storage Elements in transport applications", *Elsevier, Journal of Process Control*, Vol. 15, 2005, pp.481-491.
- [14] Z. Jiang, R.A. Dougal, "Strategy for active power sharing in a fuel-cell-powered charging station for advanced technology batteries", *IEEE, Power Electronics Specialist Conference, PESC'03*, Vol.1, pp.81 - 87.
- [15] M. Y. Ayad and al., "Voltage regulated hybrid DC power source using supercapacitors as energy storage device," *Elsevier, Energy Conversion and Management*, Vol.48, Jul. 2007, pp.2196-2202.
- [16] C. A. Ramos-Paja, C. Bordons, and all, "Minimum Fuel Consumption Strategy for PEM Fuel Cells", *IEEE Trans Industrial. Electronics*, Vol. 56, 2009, pp.685-695.
- [17] M. Garcia Arregui, "Theoretical study of a power generation unit based on the hybridization of a fuel cell stack and ultracapacitors. Application to the design of an aircraft emergency electrical network", *PhD thesis (in English)*, INP Toulouse, France, December 2007.