



HAL
open science

Efficiency Theory of switched capacitors converter

Fabien Todeschini, Philippe Benabes, Christophe Planat

► **To cite this version:**

Fabien Todeschini, Philippe Benabes, Christophe Planat. Efficiency Theory of switched capacitors converter. IMAPS 2013, Nov 2013, Tours, France. pp.CD-Rom. hal-00952251

HAL Id: hal-00952251

<https://centralesupelec.hal.science/hal-00952251v1>

Submitted on 22 Sep 2014

HAL is a multi-disciplinary open access archive for the deposit and dissemination of scientific research documents, whether they are published or not. The documents may come from teaching and research institutions in France or abroad, or from public or private research centers.

L'archive ouverte pluridisciplinaire **HAL**, est destinée au dépôt et à la diffusion de documents scientifiques de niveau recherche, publiés ou non, émanant des établissements d'enseignement et de recherche français ou étrangers, des laboratoires publics ou privés.

EFFICIENCY THEORY OF SWITCHED CAPACITORS CONVERTER

Fabien Todeschini ; Christophe Planat ; Philippe Bénabès

F. Todeschini*, P. Bénabès**, C. Planat*

*ST Microelectronics Crolles, France

**Department of signal and electrical systems, Supelec
Gif/Yvette, France

Email: fabien.todeschini, christophe.planat@st.com
philippe.benabes@supelec.fr

ABSTRACT

This paper reports on a theoretical study of the efficiency of a switched capacitor converter for autonomous sensors. The sensor is composed of an energy harvester (Solar cell), the electronic system (micro-controller, radio, temperature sensor, MEMS...) and a battery.

Based on our theory, we calculate this efficiency with respect to: the switching frequency, the capacitance values and the battery voltage. We present this using 3-D graphs.

This theory is based on Ultra-Low-Power embedded systems such as wireless sensors with photovoltaic harvesters operating in low-light conditions. In this case, the harvested energy from PV do not exceed a few tens of micro-watts, which forbids the use of "power-hungry" coil-based power converters. On the contrary, using switched capacitors converter is a better alternative for this kind of application. We here present a theoretical framework deriving the maximum efficiency achieved by a switched capacitor converter with respect to: the switching frequency, the capacitance value and the battery voltage.

***Index Terms*— Wireless Sensor Network (WSN); energy harvesting; Maximum Power Point Tracking (MPPT); switched capacitor network;**

1. INTRODUCTION

Electronic autonomous devices are increasingly present in our everyday lives. These intelligent and smart systems can remotely collect data like temperature, humidity, sound, pressure, vibration, geomagnetic field. They are therefore convenient to acquire relevant physical knowledge about our surroundings. Because of the remote access constraint, wireless sensors need to harvest energy from their environment in order to extend their battery lifetime. The best way to extract the maximum amount of power from a harvester is to track the Maximum Power Point (MPP) [1]. Different techniques

can be used depending on the required accuracy and/or the circuitry consumption and complexity constraints. The hill climbing and the Perturb and Observe methods are good examples to achieve a good accuracy but they need a micro-controller, which is not suitable for low power applications [1]. Faster techniques can also be used such as fractional open-circuit voltage [2]. The latter exploits the fact that the open circuit voltage (V_{OC}) has a near linear relationship with the voltage at maximum power point (V_{MPP}). These techniques require less processing but can result in inaccuracies as we do not know with certainty that we are working on the MPP.

Different kinds of power converters are used to extract energy depending on the harvested power and the harvester: the inductor based converters (buck, boost converters) and the switched capacitor converters (SC). Usually, inductor based converters are designed to convert high power ($>1W$) [3] and require an external inductor. SC converters are more convenient as they can be entirely integrated on chip [4] and [5].

But the efficiency of SC converters for Ultra-Low-Power remains low (below 50 % [6]). In this paper, we propose how to calculate and evaluate accurately the achievable efficiency of SC converter charging a battery from a photovoltaic cell.

This paper is organized in the following manner: The charge pump principle is presented in section 2.1. Typical photovoltaic curves and models are discussed in section 2.2. The capacitor voltage is presented in section 2.3 and the efficiency calculation and the normalized efficiency are presented in section 2.4 and 2.5 respectively. The paper is ended by a conclusion in section 3.

2. SYSTEM DESCRIPTION

2.1. The charge pump principle

A charge pump consists of an $n \times m$ matrix of capacitors and some switches (Fig 1). The matrix topology changes at each clock cycle in order to adapt the harvester voltage level to the

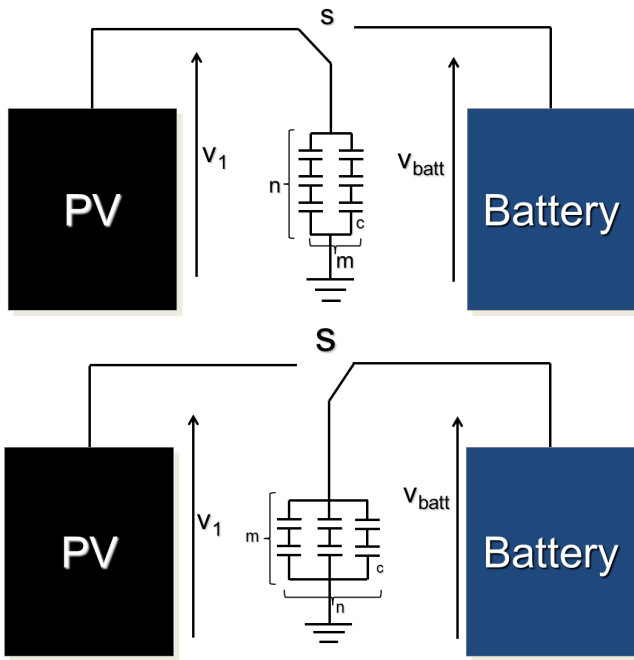

Fig. 1: 2/3 switched capacitor principle

battery voltage level. First, the capacitor matrix is connected to the photovoltaic panel (PV) and charged up to a certain value (V_1). The voltage across each capacitor is $\frac{V_1}{n}$. When this value is reached, the switches states change and the capacitors are discharged to the battery down to $\frac{V_{batt}}{m}$. The energy that is transferred from the PV to the battery is

$$\begin{aligned}
 E_C &= m \times n \times \frac{V_{batt}}{m} \times \Delta Q \\
 &= V_{batt} \times C_0 \left(V_1 - \frac{n}{m} V_{batt} \right) \quad (1)
 \end{aligned}$$

The capacitor network acts as a voltage multiplier or divider, but unfortunately also acts as a resistor. The energy lost due to the capacitor discharge is proportional to $(V_1 - \frac{n}{m} V_{batt})$. This loss essentially occurs when the PV voltage is much higher than the reported battery voltage ($\frac{n}{m} V_{batt}$).

Figure 2 presents the capacitor voltage evolution.

With a larger number of capacitors in the $n \times m$ matrix, the energy loss due to the capacitor discharge decreases. Indeed, because of the difference between the two voltages $(\frac{V_{PV}}{n} - \frac{V_{batt}}{m})$ if the value increases due to less capacitors (2×3 in this example), the loss will increase. On the contrary, with a lot of capacitors, the difference between V_{PV} and V_{batt} decreases, resulting in a smaller energy loss.

2.2. IV and PV modeling curves

A solar cell is far to be a constant voltage source. To model the solar cell curves (Current vs Voltage and Power vs Volt-

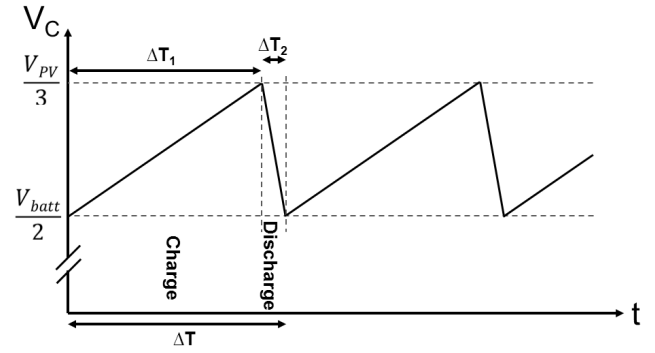

Fig. 2: Capacitor voltage evolution of a 2x3 matrix

age) we have to know how the voltage level evolves. It is equivalent to know how the internal impedance evolves when the voltage level varies.

Figure 3 shows the IV (Current-Voltage) and PV (Power-Voltage) characteristics measurements on a thin film silicon cell (amorphous solar cell). The IV curve starts from I_{SC} and decrease slowly up to the voltage at Maximum Power Point (V_{MPP}). At this point, the curve drops abruptly up to 0A at the open circuit voltage (V_{OC}). The PV curve is the IV curve multiplied by the voltage. The Maximum Power Point (MPP) can be identified at the top of the PV curve. A thin film silicon solar cell has the advantage to present the same characteristics for indoor and outdoor light conditions (natural light like sun light or artificial light like incandescent bulb, fluorescent lights will not alter the shape of the curve). The I_{SC} is proportional to the luminosity and the V_{OC} level varies logarithmically with the luminance. With the thin film solar cell used for this work, the equation of the luminance is:

$$luminance = 0.2819 \ln(V_{OC}) + 2.7041 \quad (2)$$

In this example, the capacitor network is charged on the IV curve from the reported battery voltage ($\frac{n}{m} \times V_{batt}$) that acts as a fixed voltage value, to the value V_1 . The voltage V_1 depends on the power (that is linked to the light condition), the capacitor value and the switching frequency. With a high switching frequency, V_1 will be close to $(\frac{n}{m} \times V_{batt})$. The same condition could be achieved with a smaller capacitor.

Thanks to these curves examples, we modeled them with a mathematical approach. This mathematical model is useful for the analysis and the matlab simulations especially because it is simplified. We modeled the IV curve in two parts. Indeed, the current does not change very much from the short circuit point to the optimum point. Therefore, we model this part by a small slope line starting from I_{SC} . Then the curve decreases abruptly down to the Open Circuit Voltage. This is modeled by a negative parabola that decreases from the current at MPP to the V_{OC} point. The Power vs Voltage curve is the IV curve multiplied by the voltage. The first part is the linear line starting from 0 up the Maximum Power Point. With

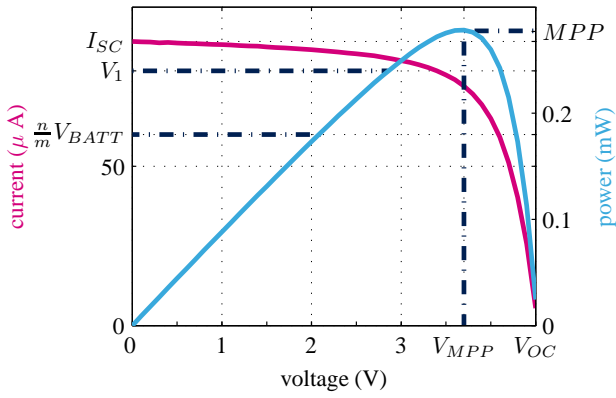

Fig. 3: IV and PV curve of an amorphous silicon solar cell

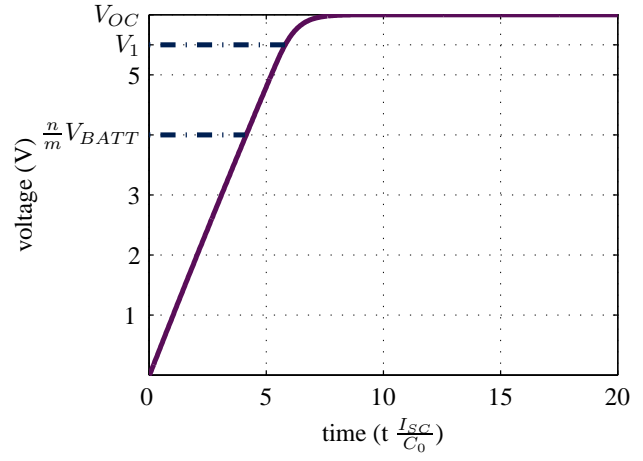

Fig. 5: Capacitor's voltage variation

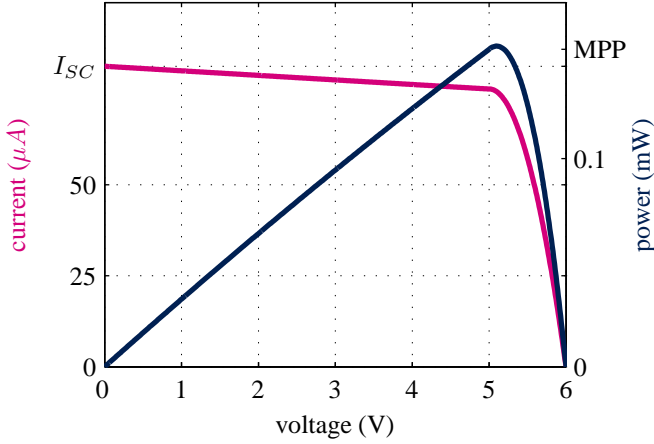

Fig. 4: Mathematical model of the PV curve

the multiplication, the second part is a negative cubic curve up to the V_{OC} . The Figure 4 shows the mathematical model of the IV and PV curves.

2.3. Capacitor voltage

The capacitors are charged while scanning the IV curve. The voltage law can be extracted from the differential equation

$$i = C \frac{du}{dt} = \frac{IV(u \times n)}{m} \quad (3)$$

Where u is the voltage across a single capacitors, and IV is the current-voltage characteristic of the PV cell. Figure 5 represents the solution of this equation starting from $0V$ at $t = 0$. In reality, the capacitor's voltage evolves from $V_{batt} \times \frac{n}{m}$ to V_1 (being determined by the charge period).

First, as the current that flows through the capacitor is almost constant ($i = I_{SC}$) the voltage across the capacitor is quite linear:

$$u_c = \frac{I_{SC} + \beta t}{C} t \approx \frac{I_{SC}}{C} t \quad (4)$$

Then the capacitors charge linearly. But as after the Maximum Power Point the current decrease abruptly down to 0, the slope of the voltage evolution across the capacitors decreases asymptotically toward V_{OC} .

2.4. Efficiency calculation

The efficiency can be derived from the previous equations. The maximum energy that can be extracted from the PV during one period is at the MPP (we suppose that ΔT_2 in fig 2 is negligible compared to ΔT):

$$E_m = I_{mpp} \times U_{mpp} \times \Delta T \quad (5)$$

The effectively transferred energy depends on the value of the unitary capacitors, the sampling frequency (f_s), and the battery voltage:

$$E_t = C_0 \times V_{batt} \times \left(V_1 - \frac{n}{m} V_{batt} \right) \quad (6)$$

In this equation, V_1 is deduced from V_{batt} and the switching period from the variation of the capacitor's voltage. (Fig 5)

The efficiency is then deduced as: $\eta = \frac{E_t}{E_m}$.

We represent the evolution of the efficiency in a 3D plot (Fig 6). The X axis is the short circuit current divided by the product of the unitary capacitor value by the sampling frequency: $\frac{I_{sc}}{f_s \times C_0}$. The Y axis is the reported battery voltage normalized by U_{mpp} .

The best efficiency (equal to 100 %) appears when the reported battery voltage is equal to the MPP and the frequency

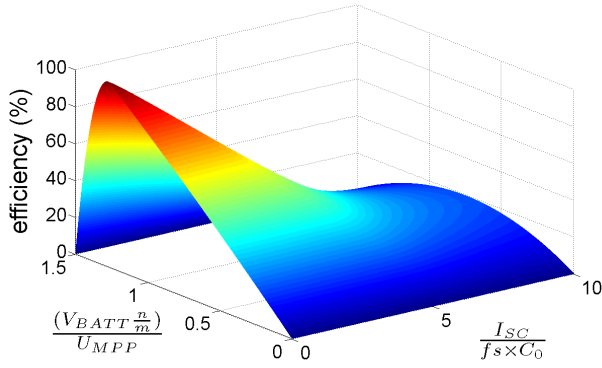

Fig. 6: Efficiency vs battery voltage and frequency x capacity

is infinite. It means that this efficiency is theoretical and cannot be achieved in a circuit. This efficiency decreases rapidly if the frequency or the capacitor value decreases because we charge the capacitors with a value different from the Maximum Power Point. For the same reason, if we charge the capacitors from a value far from the optimum voltage, the efficiency will be low whatever the charging conditions (low/high frequency). In other words, if we start to charge the capacitors before the Maximum Power Point, reaching or exceeding this point is not useful and will not increase its efficiency.

2.5. Normalized efficiency

$$\eta'(V_{batt}, fs) = \frac{\eta(V_{batt}, fs)}{\eta(V_{batt}, \infty)} \quad (7)$$

The next curve (Figure 7) shows the evolution of the normalized efficiency with respect to the frequency.

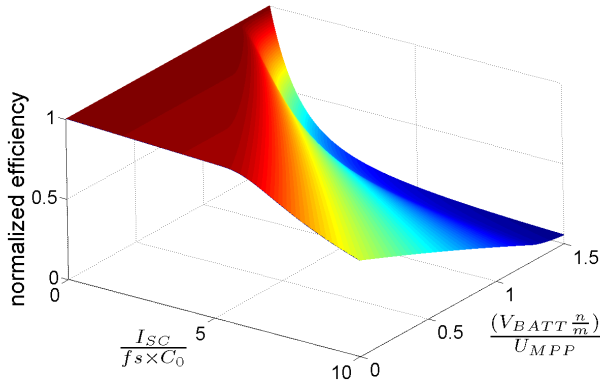

Fig. 7: Normalized efficiency vs battery voltage and frequency x capacity

We observe that when the battery voltage is low, the effi-

ciency is not affected much by the frequency. It is then more efficient to have a low switching frequency if the starting voltage ($V_{batt} \times \frac{n}{m}$) is far from the Maximum Power Point. On the contrary, when the battery voltage is above the MPP, the efficiency decreases rapidly when the frequency decreases. Therefore, it is wise to avoid charging the capacitors after the Maximum Power Point.

3. CONCLUSION

These simulations have shown the theoretical efficiency that could be reached with a switched capacitor converter. The optimal switching frequency can easily be derived from these curves. In reality, the efficiency will be reduced due to the consumption of the switching logic that is directly proportional to the sampling frequency. Furthermore, designing a switched capacitor converter with a low switching frequency for low power applications is not interesting for high efficiency conversion.

4. REFERENCES

- [1] T. Esram and P.L. Chapman, "Comparison of photovoltaic array maximum power point tracking techniques," *Energy Conversion, IEEE Transactions on*, vol. 22, no. 2, pp. 439–449, june 2007.
- [2] A.S. Weddell, G.V. Merrett, and B.M. Al-Hashimi, "Ultra low-power photovoltaic mppt technique for indoor and outdoor wireless sensor nodes," in *Design, Automation Test in Europe Conference Exhibition (DATE), 2011*, march 2011, pp. 1–4.
- [3] Ko Ko Win, Xinhui Wu, S. Dasgupta, Wong Jun Wen, R. Kumar, and S.K. Panda, "Efficient solar energy harvester for wireless sensor nodes," in *Communication Systems (ICCS), 2010 IEEE International Conference on*, nov. 2010, pp. 289–294.
- [4] M.D. Seeman, S.R. Sanders, and J.M. Rabaey, "An ultra-low-power power management ic for wireless sensor nodes," in *Custom Integrated Circuits Conference, 2007. CICC '07. IEEE*, sept. 2007, pp. 567–570.
- [5] Hui Shao, Chi-Ying Tsui, and Wing-Hung Ki, "An inductor-less mppt design for light energy harvesting systems," in *Design Automation Conference, 2009. ASP-DAC 2009. Asia and South Pacific*, jan. 2009, pp. 101–102.
- [6] D. Maurath and Y. Manoli, "A self-adaptive switched-capacitor voltage converter with dynamic input load control for energy harvesting," in *ESSCIRC, 2009. ESSCIRC '09. Proceedings of*, Sept., pp. 284–287.