



HAL
open science

Adaptive Control of Lactic Acid Production Process from Wheat Flour

Karen Vanessa Gonzalez, Sihem Tebbani, Didier Dumur, Filipa Lopes,
Dominique Pareau, Aurore Thorigné, Sébastien Givry

► **To cite this version:**

Karen Vanessa Gonzalez, Sihem Tebbani, Didier Dumur, Filipa Lopes, Dominique Pareau, et al.. Adaptive Control of Lactic Acid Production Process from Wheat Flour. 9th IFAC Symposium on Advanced Control of Chemical Processes (ADCHEM 2015), Jun 2015, Whistler, Canada. pp.1087-1092, 10.1016/j.ifacol.2015.09.113 . hal-01257041

HAL Id: hal-01257041

<https://centralesupelec.hal.science/hal-01257041>

Submitted on 12 Mar 2020

HAL is a multi-disciplinary open access archive for the deposit and dissemination of scientific research documents, whether they are published or not. The documents may come from teaching and research institutions in France or abroad, or from public or private research centers.

L'archive ouverte pluridisciplinaire **HAL**, est destinée au dépôt et à la diffusion de documents scientifiques de niveau recherche, publiés ou non, émanant des établissements d'enseignement et de recherche français ou étrangers, des laboratoires publics ou privés.

Adaptive Control of Lactic Acid Production Process from Wheat Flour

Karen Vanessa Gonzalez*** Sihem Tebbani** Didier Dumur** Filipa Lopes* Dominique Pareau*
Aurore Thorigné*** Sébastien Givry***

**LGPM, CentraleSupélec, Grande Voie des Vignes, 92295 Châtenay-Malabry, France
(e-mail: {karen.gonzalez; filipa.lopes; dominique.pareau}@centralesupelec.fr).

**Laboratoire des Signaux et Systèmes (L2S, UMR CNRS 8506) CentraleSupélec-CNRS- Université
Paris-Sud, Control Department, 3 Rue Joliot Curie, 91192, Gif-Sur-Yvette, France
(e-mail: {sihem.tebbani; didier.dumur}@centralesupelec.fr)

*** Centre de Recherche et d'Innovation Soufflet-division Biotechnologie-Groupe SOUFFLET,
Quai Sarraill, 10400, Nogent-sur-Seine, France
(e-mail: {athorigne; sgivry}@soufflet-group.com)

Abstract: The key feature of this paper is the development of a control strategy for the lactic acid production process from wheat flour in a continuous bioreactor. As lactic acid has inhibition effects on bacterial growth and its own production, the regulation of its concentration is required. In this paper, a control strategy is proposed in order to maximize the process productivity. First, the optimal setpoint is determined. Then, a controller based on a state-feedback linearizing control strategy is proposed to regulate the product concentration at its optimal value. The developed control law requires measurement or estimation of online state variables and a good knowledge of model parameters. In this paper the estimation of lactic acid production rate is proposed as an alternative to reduce the complexity of the control law. Different production rate estimators are studied and tested. Finally, the proposed control strategy results in a controller that involves the estimation of the production rate by a Kalman filter. The effectiveness of the developed strategy is illustrated by simulation results.

Keywords: bioprocess, state feedback linearizing control, Kalman filtering.

1. INTRODUCTION

Lactic acid (LA) has recently received much attention as the main monomer for the production of PLA (Poly Lactic Acid). Nevertheless, as lactic acid is a relatively cheap product, one of the major challenges in its large-scale fermentative production is the raw material cost. Cereal products and wastes could then be promising nutrient sources for the production of this monomer. Wheat flour waste has been reported as suitable for LA production (Zhao et al. 2010).

The process described in this work involves the starch liquefaction to reduce sugars (mainly maltose), a saccharification step to transform the maltose into glucose and the glucose fermentation to lactic acid. Two major factors then affect lactic acid production: nutrient limiting conditions and the inhibitory effect caused by lactic acid accumulation in the culture media (Olmos-Dichara et al. 1997). Optimizing the lactic acid production in a bioreactor and more specifically in a reactor operating in continuous mode is challenging.

The control design for most biotechnological processes is difficult due to large nonlinearities and poorly understood dynamics. Different control strategies have been proposed for fermentation processes and may provide satisfactory performances (Ben Youssef et al. 2000) (Van Impe et al. 1995). However, the majority of them concerns batch and fed-batch cultures or simpler culture broths.

This work presents the development of a control strategy that aims at improving lactic acid productivity in a continuous reactor. The control law regulates the lactic acid concentration at an optimal value, using the flow rate of the culture medium as the control variable. First, a controller based on a state-feedback linearizing control law combined with an upper level linear controller is proposed. However, as this control strategy is based on the state-feedback principle, all the system state variables must be measured or estimated online. In our process, the lactic acid concentration is the sole state measured online. Consequently, it becomes necessary to develop estimators of the non-measured states in order to use the proposed control law. In the state estimation, the quality of the estimate is not only related to the assumptions on uncertainty in the model and the parameters, but also to the convergence rate of the observers (Picó et al. 2009). Basically, it is possible to consider two main types of potential variables to be estimated: kinetic rates and species concentrations. In this paper, the chosen approach estimates the production rate directly from the measurement of lactic acid concentration. It can reduce estimator errors and the controller is less sensitive to model accuracy.

The paper is organized as follows: in section 2 the studied bioprocess is discussed and its modelling is presented. In Section 3, the optimal operating conditions are determined and then a linearizing state feedback strategy to maintain the system at this optimal setpoint is developed. Then, the

observer development for the lactic acid production rate estimation is presented in Section 4. Numerical simulations and a robustness analysis are given in Section 5. Conclusions and perspectives conclude the paper.

2. PROBLEM FORMULATION

2.1 Process description

Conventional biotechnological production of lactic acid from starch materials is relatively complex: pre-treatment of starch by gelatinisation and liquefaction, enzymatic saccharification of sugars to glucose and subsequent conversion of glucose to lactic acid by fermentation (Anuradha et al. 1999). In the first step, starch is degraded to maltose by an enzyme, alpha-amylase. Later, maltose is converted to glucose by another enzyme, amyloglucosidase, in the saccharification step. Finally, glucose is consumed by the cells for growth and lactic acid production.

A schematic diagram of the maltose saccharification step until lactic acid production (a two-stage fermentation process) is depicted in Figure 1.

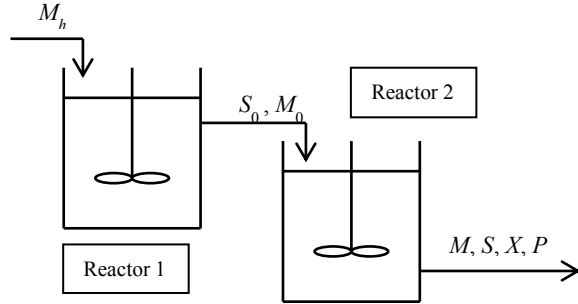

Fig. 1. Representation of maltose hydrolysis (reactor 1) followed by fermentation (reactor 2).

The final part of the saccharification step is combined with the fermentation. It means that maltose is partially hydrolysed in reactor 1 and then, the remaining maltose is hydrolysed simultaneously with the fermentation (in reactor 2). M_h represents the inlet maltose concentration to the saccharification step; M_0 and S_0 are maltose and glucose concentrations feeding the reactor 2, respectively. M , S , X and P are maltose, glucose, biomass and lactic acid concentrations (in g/L) in the fermenter, respectively. This paper only focuses on modelling and control of reactor 2.

2.2 Model development

As glucose in the second reactor is produced (by maltose saccharification) and consumed (by bacterial fermentation) simultaneously, the mathematical model for the process should take into account maltose contribution in glucose dynamics. A model is developed including four dynamical equations: biomass (cell, X) growth, substrate (glucose, S) consumption, product (lactic acid, P) formation and maltose (M) degradation.

System dynamics are based on mass balance equations under the assumption of a continuous stirred tank reactor (CSTR) and are given by the following relations:

$$\dot{X} = \mu X - DX \quad (1a)$$

$$\dot{S} = -\frac{1}{Y_X} \mu X - D(S - S_0) + k_M M \quad (1b)$$

$$\dot{P} = \frac{Y_P}{Y_X} \mu X - DP \quad (1c)$$

$$\dot{M} = -k_M M - D(M - M_0) \quad (1d)$$

where μ is the specific growth rate (in h^{-1}), D is the dilution rate (h^{-1}) defined as the ratio of the feed flow rate over the effective reactor volume. Y_P and Y_X are product and biomass yields with respect to glucose respectively (in g/g), k_M is the maltose degradation constant (in h^{-1}).

In the literature, it has been observed that product inhibition occurs in fermentations performed with the same bacterial strains as those used in this work. So in the present study, the cell growth rate including product inhibition is described by:

$$\mu = \mu_{\max} \frac{S}{k_S + S} \left(1 - \frac{P}{P_{\max}} \right)^n \quad (2)$$

where μ_{\max} is the maximal specific growth rate (in h^{-1}), k_S is the half saturation constant (g/L), n the inhibiting power concerning lactic acid and P_{\max} the maximal lactic acid concentration (in g/L). The term in (2) involving the substrate concentration represents the growth limitation by the substrate according to the Monod model. The second term models the growth inhibition by the product (i.e. for high product concentration, the growth rate decreases).

3. PROCESS CONTROL

3.1 Optimal setpoint

The aim of the control law will be to maintain the system at the optimal setpoint. The latter was determined for a modified model of the system (1a-d) in which the maltose concentration and dynamics are neglected. This assumption helps simplifying the mathematical developments and is justified by the fact that the maltose concentration does not have an important effect on variables dynamics. It is because the glucose concentration feeding the bioreactor is high enough to render the maltose contribution in the glucose dynamics low. The glucose dynamics is then described by:

$$\dot{S} = -\frac{1}{Y_X} \mu X - D(S - S_0) \quad (3)$$

The optimal setpoint is calculated to maximize lactic acid productivity defined as the product of the dilution rate by lactic acid concentration (DP). It can be formulated as a constrained optimization problem as follows:

$$\begin{aligned} \bar{P}^* &= \arg \max_{\bar{P}} \bar{D} \cdot \bar{P} \\ \text{s.t.} \quad & \text{Eq. (1a), (1c), (3), (2) at the equilibrium} \\ & 0 \leq \bar{D} \leq D_{\max}. \end{aligned} \quad (4)$$

where \bar{D} and \bar{P} are the steady state dilution rate and lactic acid concentration, respectively. D_{\max} is the maximal dilution rate allowed by the experimental setup. Figure 2 gives the evolution of the criterion ‘‘productivity’’ for different values of steady state product concentrations. It can

be noticed that the objective function is concave and has only one maximum, which simplifies the optimization procedure.

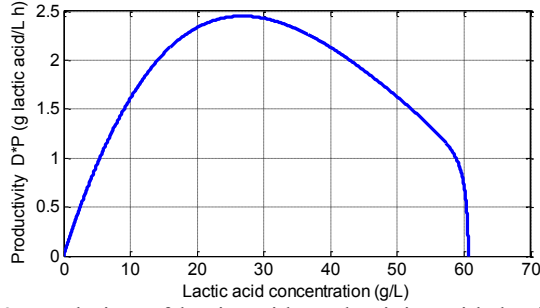

Fig. 2. Evolution of lactic acid productivity with lactic acid concentration

The numerical optimization of problem (4) is presented in (Gonzalez et al., 2014). Hereafter, the bioreactor will be maintained at this optimal setpoint by regulating the product concentration at its optimal value (here equal to 27 g/L).

3.2. State-feedback controller

The system (1) can be rewritten in the state-space formalism as follows:

$$\begin{aligned} \dot{x}_r(t) &= f(x_r) + g(x_r)u \\ y(t) &= h(x_r) \end{aligned} \quad (5)$$

with $x_r = (X, S, P)^T$, $u = D$ and $y = P$.

Due to restriction in the software for future experimental validation, a simple control strategy is preferred. Since, system (5) is a control-affine one, a state-feedback linearizing controller is implemented in an inner loop to track the setpoint. In addition, a Proportional controller is used in the outer loop (Fig. 3). For an initial approach, it will be assumed that all state variables are measured online.

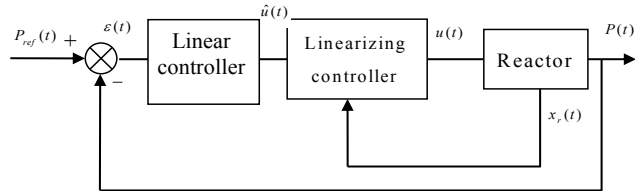

Fig. 3. Control strategy architecture

The application of the state-feedback linearization theory leads to the following control law (Gonzalez et al., 2014):

$$D = -\frac{1}{P} \left[\hat{D} - Y_p \frac{\mu}{Y_X} X \right] \quad (6)$$

The control signal \hat{D} will be delivered by the outer-loop by means of a Proportional controller:

$$\hat{D} = G_1 (P_{ref} - P) \quad (7)$$

where P_{ref} is the reference product concentration., G_1 is the controller gain, tuned to provide a desired closed-loop time response.

3.3. Need for an observer

The control law (6-7) needs the knowledge of state variables.

However, only the product concentration is available online. A classical approach consists in reconstructing the unavailable state variables from the online measurement. This could be a difficult task because of the strong nonlinearity of the model.

In this work, the production rate of lactic acid, defined as $\gamma = \mu XY_p / Y_X$ (in g/L/h), is estimated instead of the state variables and is further introduced in (6), leading to:

$$D = -\frac{1}{P} [\hat{D} - \hat{\gamma}] \quad (8)$$

where \hat{D} is given by (7), $\hat{\gamma}$ is the estimated production rate. The advantage of this controller is that the estimation algorithm is simplified, and the controller (8) does not involve any growth model, leading to a more robust control strategy than the control law (6). This will be highlighted by simulation results in the following sections.

The stability of the resulting closed-loop system is discussed in Appendix A. In the next section, different observers are proposed to calculate an estimate of the production rate γ .

4. ESTIMATION OF THE PRODUCTION RATE

Three estimation strategies are developed and will be presented hereafter. Due to restriction in the software for future experimental validation, only observers with simple structures are considered.

4.1. Numerical differentiation

From (1c), a simple way to calculate an estimation of γ is to use the product concentration and its first order derivative:

$$\hat{\gamma} = \dot{P} + DP \quad (9)$$

The first derivative \dot{P} could be calculated by a backward differentiation technique. However, in case of noisy measurements of P , this approach can lead to a very bad estimation. A classical approach to avoid this phenomenon consists in filtering the noisy signal. In this paper, the technique proposed in (Fliess et al., 2008) was considered. It uses a moving horizon time-integration of the noisy signal in order to reconstruct its first derivative. The first derivative of the product concentration is then calculated by:

$$\hat{\dot{P}} = -\frac{3!}{T^3} \int_0^T (T-2t)P(t)dt \quad (10)$$

where $[0, T]$ is a quiet "short" time window and t is the time.

4.2. The Kalman filter

In the two following approaches, the production rate is estimated by means of a Kalman filter. The Kalman observer allows estimating the state of the system from its past control and measurement values. This approach minimizes the variance of the estimation error and has the advantage to use a feedback structure (Lewis et al., 2008). It consists of a prediction phase of the system state, and a correction phase of the predicted value taking into account measurements. The Kalman principle is applied in two cases: constant and linear production rate models. These two cases are presented

hereafter. The tuning of these two estimators will be discussed in the results section.

4.2.1. Constant production rate model

First, the production rate is assumed to be constant. The system to be considered for the estimation problem is as follows:

$$\begin{cases} \dot{P} = \gamma - DP \\ \dot{\gamma} = 0 \end{cases} \quad (11)$$

This model is first discretized. Indeed, the control and estimation strategies will be implemented online in a discrete form. As system dynamics are slow enough, the Euler discretization scheme provides good approximation, at a sampling time T_e . Stochastic signals are further included in the model:

$$\begin{bmatrix} \hat{P}_{k+1} \\ \hat{\gamma}_{k+1} \end{bmatrix} = \begin{bmatrix} -D_k T_e + 1 & T_e \\ 0 & 1 \end{bmatrix} \begin{bmatrix} \hat{P}_k \\ \hat{\gamma}_k \end{bmatrix} + \begin{bmatrix} v_{1,k} \\ v_{2,k} \end{bmatrix} \quad (12)$$

$$\hat{P}_k = [1 \quad 0] \begin{bmatrix} \hat{P}_k \\ \hat{\gamma}_k \end{bmatrix} + w_k \quad (13)$$

where k in subscript represents the discrete time index, the dilution rate is discretized and assumed to be piecewise constant. v and w are the process and measurement noises respectively. They are assumed to be centred Gaussian white noises with covariance matrices Q and R respectively.

The discrete Kalman filter theory (Lewis et al., 2008) is applied to the system (12-13) to reconstruct the product concentration and production rate from measurement of product concentration.

4.2.2. Linear production rate model

Another possibility to model the evolution of the production rate with time is to consider a linear behaviour. This assumption is more accurate in case of a batch culture or during transient phase of a continuous culture. The model is in this case given by:

$$\begin{cases} \dot{P} = \gamma - DP \\ \dot{\gamma} = 0 \end{cases} \quad (14)$$

As in the previous case, the model is discretized and additive noise signals are included to model uncertainties.

$$\begin{bmatrix} P_{k+1} \\ \gamma_{k+1} \\ \dot{\gamma}_{k+1} \end{bmatrix} = \begin{bmatrix} -D_k T_e + 1 & T_e & 0 \\ 0 & 1 & T_e \\ 0 & 0 & 1 \end{bmatrix} \begin{bmatrix} P_k \\ \gamma_k \\ \dot{\gamma}_k \end{bmatrix} + \begin{bmatrix} v_{1,k} \\ v_{2,k} \\ v_{3,k} \end{bmatrix} \quad (15)$$

$$P_k = [1 \quad 0 \quad 0] \begin{bmatrix} P_k \\ \gamma_k \\ \dot{\gamma}_k \end{bmatrix} + w_k \quad (16)$$

In this case, the state to be estimated includes also the first derivative of the production rate. As previously, a discrete Kalman filter will be used.

5. NUMERICAL RESULTS

In this section, the estimation and control strategies are validated in simulation. Model parameters were determined

from experimental data, with the identification strategy proposed in (Gonzalez et al., 2013). Identified values are given in Table 1. The data used for simulation are given in Table 2.

In a first step, the performances of the three developed estimation strategies were tested in simulation. Simulations lasted 30 hours, with a sampling time $T_e = 5$ min. Two cases were considered: a constant (Figs. 4 and 5) and a time varying (Fig. 6) dilution rate.

Table 1. Model parameters values

Parameter	Identified Value
μ_{\max} (h ⁻¹)	0.21
Y_X (g/g)	0.058
Y_P (g/g)	0.82
k_M (h ⁻¹)	0.03
k_S (g/L)	0.50
P_{\max} (g/L)	108.18
n	3

Table 2. Simulation conditions

Variable	Value
$P(0)$ (g/L)	20
$X(0)$ (g/L)	0.2
$S(0)$ (g/L)	74
$M(0)$ (g/L)	50
D_{\max} (h ⁻¹)	0.4
P_{ref} (g/L)	27
G_1	6

Results obtained for a constant dilution rate with the numerical differentiation approach, the Kalman filter with a constant model for γ (referred to as Kalman 1 hereafter) and the Kalman filter with a linear model for γ (referred to as Kalman 2) are presented in Fig. 4. The simulation started in batch mode ($D = 0$) and at 15 h and onwards, a dilution rate of 0.1 h⁻¹ was applied. The initial value of γ is calculated from the considered growth rate model (2). The lactic acid concentration online measurement is performed using the base solution injected for pH regulation. Experimental assays show that the lactic acid concentration is well estimated by this approach (good accuracy and very low measurement noise). The covariance matrices Q and R for Kalman filter are chosen diagonal as follows. Kalman filter 1: $Q = \text{diag}([0.01; 0.01])$, $R = 0.01$. Kalman filter 2: $Q = \text{diag}([0.01; 0.01; 0.01])$, $R = 0.01$. The window for numerical differentiation is chosen equal to $20T_e$ (by a trial-and-error technique).

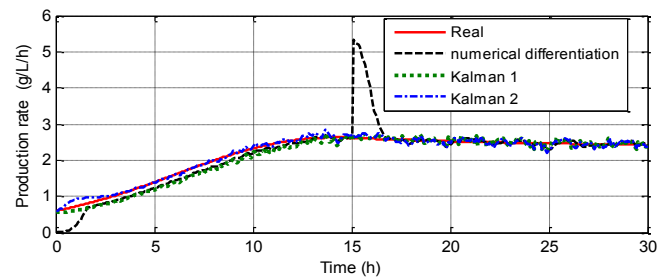

Fig. 4. Observer (production rate) performances for piecewise constant dilution rate.

With the numerical differentiation method, a discontinuity is observed when the dilution rate changes. The two Kalman filters present a better performance than the numerical differentiation. The zoom on the production rate (Fig. 5) shows that the Kalman filter 1 performs well when the dilution rate is not zero, but an offset is present when $D = 0$. In the case of the Kalman filter 2, an overestimation of the production rate occurs for the first 2 hours of fermentation. Then, the estimated value of γ is very close to the real one. In steady-state both filters lead to quite similar performances.

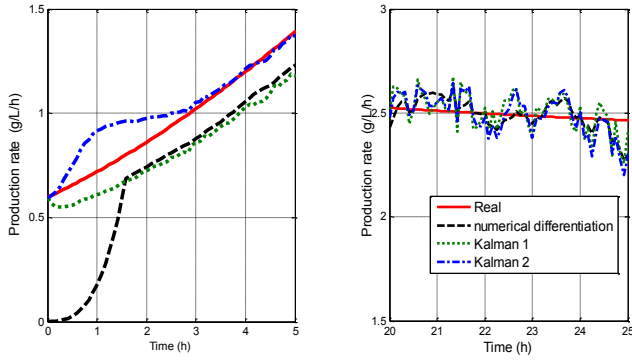

Fig. 5. Zoom on production rate estimation during the first 5 hours (on the left) and at steady-state (on the right).

Secondly, a sinusoidal time varying dilution rate is considered (Fig. 6), in order to test the performance of the three estimation strategies, even if this kind of variations is not necessarily realistic from the point of view of real operating conditions. It should be pointed out that in this case, systems (12) and (15) are time-varying, while they were stationary in the case of a constant dilution rate. In this case, no measurement noise was included to focus the study on the performance with respect to the dilution rate evolution. In addition, the estimators were initialized at 0 in order to study their performance with respect to initialization error.

From Fig. 6, it can be noticed the bad performance of the numerical differentiation strategy. This behaviour is mainly due to the choice of the sampling time which is not small enough in comparison to the variation of D . Consequently, the finite difference presents a poor accuracy. The two Kalman filters reconstruct the production rate with a good accuracy. An error is however present but it remains small and bounded.

As a conclusion, the estimation of the production rate by Kalman filtering leads to good performances. The Kalman filter 2 (with linear model for γ) shows the best performance. Consequently, hereafter, the Kalman filter 2 was chosen to be implemented in the control law proposed in (8).

In a second step, the control strategy is studied in simulation (referred to as Control 2 hereafter). Its performances are compared to those obtained by the classical state feedback control strategy given by (6), referred to as Control 1. In this case, the state variables are assumed to be available online. The control objective is the regulation of the lactic acid concentration at its optimal value, 27 g/L (Gonzalez et al., 2014). The control law parameters are given in Table 2.

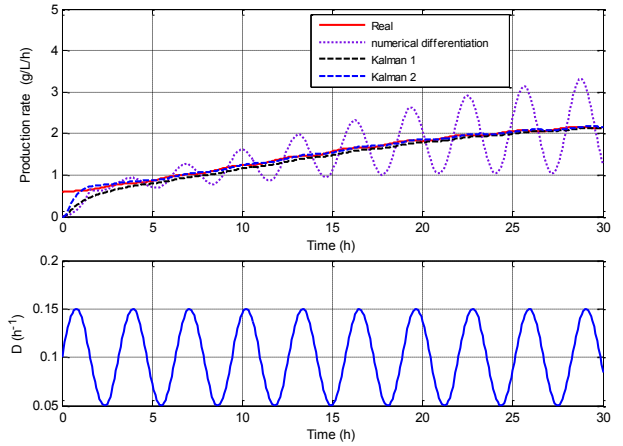

Fig. 6. Observer (production rate) performances for sinusoidal dilution rate.

In order to test the robustness of the control laws with respect to model mismatch, a 30% non-correlated parameters mismatch is applied to the real system (i.e. parameters of the real process are different by 30% from those used in the model considered in the control law). The performance of both control laws is illustrated in Fig. 7. In both cases, at the beginning of the fermentation, the dilution rate is null: the fermenter operates in open-loop which corresponds to a batch operation. Once the product concentration reaches its reference value, the dilution rate is increased in order to maintain the lactic acid concentration constant and equal to its reference value. The setpoint is reached after 1.5 h of fermentation with a good transient behaviour. As shown in Fig. 7, a steady state error is obtained using the control strategy 1. This steady error can be corrected by the implementation of an integral action in the outer-loop (Gonzalez et al, 2014). This was not tested in this work as this action can lead to saturation problems due to the dilution rate limits. In the case of the control law 2, there is a slight steady error. It should be pointed out that this controller is robust with respect to model mismatch since it does not use growth model.

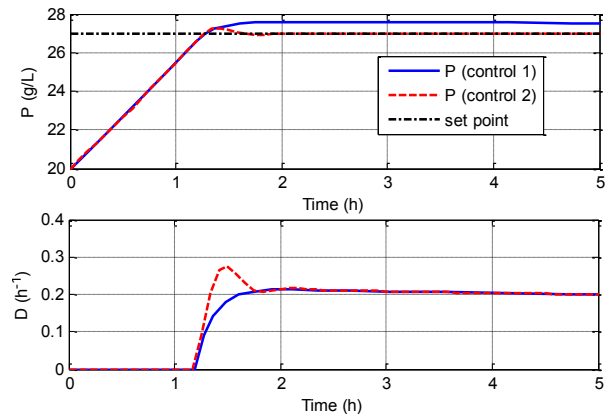

Fig. 7. Control law performances for reference tracking. Product concentration and dilution rate versus time.

In conclusion, the proposed feedback linearizing controller shows equivalent (in the nominal case or slight model mismatch) or better performances than the feedback linearizing control with all states supposed to be measured

(since, the uncertain variable γ involved in the linearizing law is online estimated). In addition, including the estimation of state variables in the control 1 could lead to worse performances. The proposed control strategy presents a good transient response with good accuracy and robustness. Moreover, the control law structure is simple and can be used for experimental validation.

6. CONCLUSIONS

A control strategy to regulate lactic acid concentration at its optimal value was proposed. The control strategy using a feedback linearizing control law combined with an upper level linear proportional controller was studied. To implement the classical state-feedback control strategy, all state variables should be measured or estimated in real time. Consequently, in order to reduce the control law complexity, the controller is developed including only an additional estimation of the production rate. Three different approaches were considered. Among them, a Kalman filter with a linear model for the production rate dynamics was chosen to be implemented in the control law. Simulations showed the accuracy and robustness of the proposed control strategy.

Further work will consider the design of states estimators for the process monitoring as the Extended Kalman Filter or Unscented Kalman Filter. Additionally, the experimental validation of the control strategy will be carried out on a lab-scale reactor. Furthermore, a control law for the two reactors will be developed.

REFERENCES

- Anuradha, R., Suresh, A.K., Venkatesh, K.V. (1999). Simultaneous saccharification and fermentation of starch to lactic acid. *Process Biochemistry*, 35(3-4), pp.367–375.
- Ben Youssef, C., Guillou, V., Olmos-Dichara, A. (2000). Modelling and adaptive control strategy in a lactic fermentation process. *Control Engineering Practice*, 8(11), pp.1297–1307.
- Fliess, M., Join C., Sira-Ramirez, H. (2008). Non-linear estimation is easy. *International Journal of Modelling Identification and Control*, (4), pp. 12-27.
- Gonzalez, J., Fernandez, G., Aguilar, M., Baron, M., Alvarez-Ramirez, J. (2001). Sliding mode observer-based control for a class of bioreactors. *Chemical Engineering Journal*, 83, pp 25-32.
- Gonzalez, K., Tebbani, S., Dumur, D., Pareau, D., Lopes, F., Givry, S., Entzmann, F. (2014). Control strategy for continuous lactic acid production from wheat flour. *In Proceedings of 2nd International Conference on Control, Decision and Information Technologies - CoDIT'14*, Metz, France.
- Gonzalez, K., Tebbani, S., Dumur, D., Pareau, D., Lopes, F., Givry, S., Entzmann, F. (2013). Modeling and parameter identification of the batch lactic acid production process from wheat flour. *In Proceedings of 17th International Conference on System Theory, Control and Computing - ICSTCC 2013*, Romania.
- Lewis, F.L., Xie, L., Popa, D. (2008). *Optimal and Robust Estimation: With an Introduction to Stochastic Control Theory* Second Edition, CRC Press. 2008.
- Olmos-Dichara, A., Ampe, F., Uribealrrea, J.L., Pareilleux, A., Goma, G. (1997). Growth and lactic acid production by *Lactobacillus casei* ssp. *rhamnosus* in batch and membrane bioreactor: influence of yeast extract and Tryptone enrichment. *Biotechnology Letters*, 19(8), pp.709–714.
- Picó, J., De Battista, H. & Garelli, F. (2009). Smooth sliding-mode observers for specific growth rate and substrate from biomass measurement. *Journal of Process Control*, 19(8), pp.1314–1323.
- Van Impe, J.F., Bastin, G. (1995). Optimal adaptive control of fed-batch fermentation processes. *Control Engineering Practice*, 3(7), pp.939–954.
- Zhao, B. et al. (2010). Kinetics of D-lactic acid production by *Sporolactobacillus* sp. strain CASD using repeated batch fermentation. *Bioresource technology*, 101(16), pp.499–505.

APPENDIX A. CONTROL LAW STABILITY

Recalling the demonstration of (Gonzalez et al., 2001) with the following assumptions: 1. All concentrations have finite values; 2. Only on-line measurements of the lactic acid concentration are available 3. The functions for the model coefficients are bounded and unknown; 4. The Kalman filter used for production rate estimation leads to estimation bounded error and 5. The stability analysis is performed for the continuous operation, $D>0$. The linearizing controller is:

$$D = -[G_1(P_{ref} - P) - \hat{\gamma}]/P \quad (A.1)$$

Renaming the regulation error as: $\tilde{P} = P - P_{ref}$. The dynamics for the regulation error is (from (1.c, A.1)):

$$\dot{\tilde{P}} = -G_1\tilde{P} + \tilde{\gamma} \quad (A.2)$$

where $\tilde{\gamma}$ is the estimation error ($\tilde{\gamma} = \gamma - \hat{\gamma}$). Solving (A.2) leads to:

$$\tilde{P}(t) = \tilde{P}(0) \exp(-G_1 t) + \int_0^t \exp(G_1(\sigma - t)) \tilde{\gamma}(\sigma) d\sigma \quad (A.3)$$

where $\tilde{P}(0)$ is the initial condition for $\tilde{P}(t)$. Taking the absolute value of (A.3) we obtain:

$$|\tilde{P}(t)| \leq |\tilde{P}(0)| \exp(-G_1 t) + \int_0^t \exp(G_1(\sigma - t)) |\tilde{\gamma}(\sigma)| d\sigma \quad (A.4)$$

When $t \rightarrow \infty$:

$$\lim_{t \rightarrow \infty} |\tilde{P}(t)| \leq \lim_{t \rightarrow \infty} \int_0^t \exp(G_1(\sigma - t)) |\tilde{\gamma}(\sigma)| d\sigma \leq \theta \quad (A.5)$$

Let $\tilde{\gamma}_m = \max\{|\tilde{\gamma}(\sigma)|\}$ be the maximum value of $|\tilde{\gamma}(t)|$ (this maximum value exists from Assumption 4), then:

$$\theta \leq \tilde{\gamma}_m \lim_{t \rightarrow \infty} \int_0^t \exp(G_1(\sigma - t)) d\sigma \leq \frac{\tilde{\gamma}_m}{G_1} \quad (A.6)$$

Leading to:

$$\lim_{t \rightarrow \infty} |\tilde{P}(t)| \leq \frac{\tilde{\gamma}_m}{G_1} \quad (A.7)$$

Thus, the steady error of the proposed controller is bounded. This error could be reduced by increasing the value of G_1 .