



HAL
open science

Antenna array in 3D to improve tracking of small HF RFID tag

Salhi Miyassa, Megdouda Benamara, Marjorie Grzeskowiak, Gaelle Bazin Lissorgues, Antoine Diet, Yann Le Bihan

► **To cite this version:**

Salhi Miyassa, Megdouda Benamara, Marjorie Grzeskowiak, Gaelle Bazin Lissorgues, Antoine Diet, et al.. Antenna array in 3D to improve tracking of small HF RFID tag. IET Microwaves Antennas and Propagation, 2018, 12 (5), pp.678-683. 10.1049/iet-map.2017.0540 . hal-01691564

HAL Id: hal-01691564

<https://centralesupelec.hal.science/hal-01691564>

Submitted on 24 Jun 2019

HAL is a multi-disciplinary open access archive for the deposit and dissemination of scientific research documents, whether they are published or not. The documents may come from teaching and research institutions in France or abroad, or from public or private research centers.

L'archive ouverte pluridisciplinaire **HAL**, est destinée au dépôt et à la diffusion de documents scientifiques de niveau recherche, publiés ou non, émanant des établissements d'enseignement et de recherche français ou étrangers, des laboratoires publics ou privés.



Open Archive Toulouse Archive Ouverte (OATAO)

OATAO is an open access repository that collects the work of some Toulouse researchers and makes it freely available over the web where possible.

This is an author's version published in: <https://oatao.univ-toulouse.fr/23834>

Official URL : <https://doi.org/10.1049/iet-map.2017.0540>

To cite this version :

Miyassa, Salhi and Benamara, Megdouda and Grzeskowiak, Marjorie and Lissorgues, Gaëlle and Diet, Antoine and Le Bihan, Yann Antenna array in 3D to improve tracking of small HF RFID tag. (2018) IET Microwaves, Antennas & Propagation, 12 (5). 678-683. ISSN 1751-8725

Any correspondence concerning this service should be sent to the repository administrator:

tech-oatao@listes-diff.inp-toulouse.fr

Antenna array in 3D to improve tracking of small HF RFID tag

Salhi Miyassa¹ ✉, Megdouda Benamara¹, Marjorie Grzeskowiak¹, Gaëlle Lissorgues¹, Antoine Diet², Yann Le Bihan²

¹ESYCOM EA 2552, UPEMLV – ESIEE PARIS – CNAM, Cité Descartes, F. 77454 Marne-La-Vallée, France

²GEEPS (PIEM) UMR 8507, Univ. Paris Saclay, F. 91192 Gif-Sur-Yvette, France

✉ E-mail: miyassa.salhi@univ-paris-est.fr

Abstract: This paper presents an improvement of small RFID tags detection in HF near field, whatever their lateral and angular misalignments, using a complementary sub-coils reader antenna, enhanced by coplanar weakly-coupled resonators, and conformed on a 3D tube. The key ideas of detection improvement are: (i) modification of B -field vector distribution with the complementary coils above the common edge of consecutive loops; (ii) increase of B -field vector diversity and magnitude distribution by a 3D structure conformed on the tube, by realising 2 pairs of Identical Coaxial Loops (ICLs) with face-to-face sub-coils in forward current, and (iii) enhancement of B -field magnitude distribution by resonators included in the complementary sub-coils. Numerical simulations are carried out using High Frequency Structure Simulator (HFSS). The studied figure-of-merit is the mutual inductance between the tag and the reader coil. Results are reported for the 4 planar complementary sub-coils, the previous structure conformed on the tube and for the structure in which RCL resonators are added in the 3 planar complementary sub-coils. Experimental detection range measurements of each fabricated structure drives to the enhancement of the 3D complementary 4×3 sub-coils structure with weakly-coupled RLC resonators in each-sub-coil in terms of read-out distance and detection surface area.

1 Introduction

Nowadays, applications of tracking and logistics can be fruitfully assisted by radio-frequency identification (RFID) [1]. RFID technologies can operate in radiative far-field or magnetic coupling near-field. The RFID radiative systems (860 MHz) are preferred in the case of free-space and long range while the magnetic coupling ones (rarely capacitive) in RFID low-frequency (125 kHz) and high-frequency (HF) (13.56 MHz) are dedicated to short range applications in dissipative media as sea water or biological tissues [1]. In magnetic coupling RFID applications, the transponders responses are detected by the reader as a load modulation of the induced field, while for the radiative ones the reader is sensitive to the field reflected by the transponder. In our case, the objective is to transfer energy and follow up small moving objects or animals such as rats (see Fig. 1) where a transponder is positioned on their head [2], with the idea to monitor some physiological parameters, thanks to the RFID physical link (pH, temperature etc.). To avoid absorption in biological tissues and to transfer energy in a short

distance, the inductive coupling is preferred. The maximum read-out distance between the reader and the transponder could be equal to 10 cm, similar to the maximum size of the rat body [2]. The transponder is thought to be positioned on small moving animal, i.e. the size of the transponder is small and its orientation is arbitrary and changes continuously while the volume of prospection is wide. The double objective of this work is to favour both B -field diversity and intensity inside a volume of detection.

In HF RFID inductive coupling, the physical link is affected by the size of the coils, by the distance between the reader and the transponder (called tag), and by the lateral and angular misalignments between them [3–5]. To improve the detection ability whatever the orientation and position of the transponder, the design of some sub-coils can be geometrically optimised in shape [4–8].

The sub-coils can be associated in series in more complex structure as the complementary sub-coils on two-dimensional (2D) solutions [7–10]. Resonators can be added, often weakly coupled to

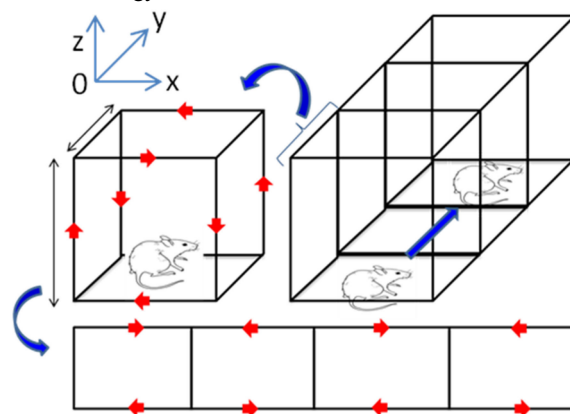

Fig. 1 Proposed structure of detection in 3D (top). Each one of the three sub-cube is composed by four coils on each surface (bottom). All surfaces of the cube are supposed to include one of the complementary-coils

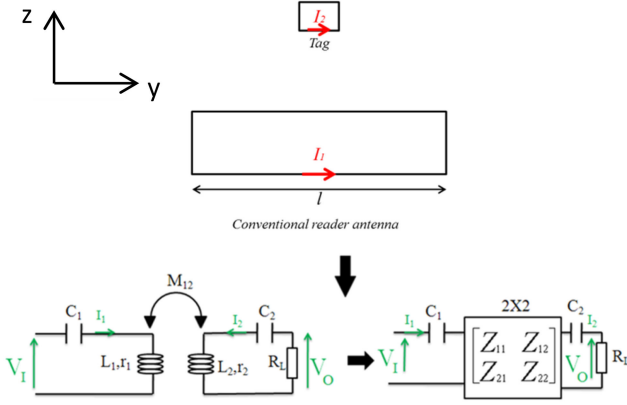

Fig. 2 Electrical model of a conventional reader coil and a tag

the reader coil [6, 11] to minimise the mistuning. In addition, this avoids a modification of the structure main geometry, keeping the ability to modify the magnetic field distribution. Mainly, these two key ideas are combined in that paper.

The complementary sub-coils advantage is to allow an additional detection possibility of a transponder, placed perpendicularly to the reader plane above the edge between consecutive sub-coils [10–12]. This orientation corresponds to the worst case for non-complementary sub-coils. As a reference design for our test, the conformal complementary sub-coils on a cylindrical tube is a 3D structure based on identical coaxial loops (ICLs), which maximises the detection ability in both parallel (i.e. the normal to the tag coil is parallel to the one of the reader) and perpendicular (i.e. the normal to the tag coil is perpendicular to the one of the reader) orientations, under the assumption that the tag is moving. Following this idea, our work is to focus on the ability to detect the tagged rats in a cube volume, as shown in Fig. 1.

Previous studies [12–14] enable to propose some 3D structures for detection of the tags whatever their orientation and position, dynamically. Moreover, such structures suffer from the fast decrease of the B -field magnitude from the coils towards the centre of the structure, i.e. in the case of a tube which will be presented in this paper, from the surface of the cylindrical exterior towards the central axis. Additionally, the distribution of the field, in the case of ICL [8, 13, 14], leads to a null field at the centre of the detection volume, due to the opposite phases of the currents and the symmetry of the structure. This is also the case for our study, as the ICLs structure is transposed in the case of the cube, as shown in Fig. 1.

As a null field is present at the centre of the detection volume, two possibilities can be investigated to overcome this penalty: (i) to modify the structure by introducing physically a non-symmetry which will cause the modification of the B -field distribution or (ii) to create the non-symmetry by an electrical coupling with additional resonators inside the sub-coils planes. These resonators will modify the B -field distribution in function of their size, position, and tuning.

This paper focuses on the potential of this second proposition, while the previous work [13] did not propose it. Another important difference with this previous work is that the size of the transponder, which was an ISO credit card size, can potentially be reduced because of the introduction of a resonator which will create some concentration of the B -field (increase in magnitude), and consequently the equivalent surface of the tag would be able to recover more power if its orientation is appropriate. We used, herein, some small RFID commercial MIFARE tags ($\varnothing = 2$ cm) and the detection tests are led for one of the three planar sub-coils lines of the general 3D structure, composed by a 4×3 array, as shown in Fig. 1.

The addition of resonator coupled to each sub-coil permits to enhance the B -field magnitude distribution while it can disrupt the resonance frequency of the reader impedance: a compromise has to be chosen between the strength of the inductive coupling and the frequency shift to avoid causing null of RFID detection. The studied parameters to compare will be the simulated mutual

inductance and the measured RFID read-out distance versus the lateral misalignment in parallel and in perpendicular configurations.

In the following section, the mutual inductance for a four complementary planar sub-coils is enhanced in comparison with a single rectangular coil with the same surface for the parallel and perpendicular orientations and validated by read-out distance detection measurements. Then, one fabricated four complementary planar sub-coils structure is conformed onto the external surface of a cylindrical tube and an equivalent mutual inductance is reported versus angular misalignment. The performances are that RFID detection volume is increased considering the cumulated possible cases for tag orientations. In the last part, the equivalent mutual inductance is calculated with one resonator inserted in each planar sub-coil. An increase of the equivalent mutual inductance is observed for both orientations and allows increasing the detection range. The association of the 3D antenna array with weakly-coupled resonators in each sub-coil creates peaks of equivalent mutual inductance without noticeable frequency shift. The detection ability is improved inside and outside a wide detection volume for the 3D structure. The addition of resonators coupled to the complementary coils can be fruitful for a randomly orientated transponder and, consequently, for the physiological follow-up of a small moving animal.

2 Theoretical study

HF RFID systems are based on the magnetic coupling. The current flow in the reader antenna generates a magnetic field. Regarding the tag, this field induces an electromotive force in the tag loop, the tag chip is loaded and the tag response is detected by the reader as load modulations of the induced field [1, 6, 11]. Miniaturisation of the tag, needed for rats tracking with an arbitrary position and orientation due to the animal displacement, reduces the magnetic coupling and degrades the induced current on the tag hardware at the read-out distance. In this case of weak magnetic coupling, higher magnetic field implies greater RFID read-out distance without considering the detuning in a first step. In our study, the figure-of-merit to quantify the magnetic coupling is the mutual inductance between the reader and the tag: it has to be increased over a large area at required read-out distance.

To determinate the equivalent mutual impedance between the reader coil and the tag coil, we use the electrical equivalent model shown in Fig. 2. L_1 and L_2 are the self-inductances of the reader coil and the tag coil, respectively, with their internal resistances r_1 and r_2 . C_1 and C_2 are the tuning capacitors at 13.56 MHz.

The voltages at the terminals/ports of each coil are expressed as follows:

$$\begin{cases} V_1 = Z_{11}I_1 + Z_{12}I_2 = \left(j\omega L_1 + r_1 + \frac{1}{j\omega C_1} \right) I_1 + j\omega M_{12}I_2 \\ V_2 = Z_{21}I_1 + Z_{22}I_2 = j\omega M_{21}I_1 + \left(j\omega L_2 + r_2 + \frac{1}{j\omega C_2} \right) I_2 \end{cases}$$

where $M_{12} = M_{21}$ is the mutual inductance between the two coils of the RFID system.

In the case of the twisted loop antenna (TLA), each sub-coil is modelled by a series of inductors, including their internal resistances, as shown in Fig. 3. The two juxtaposed coils are fed in the out-of-phase current, which improves the mutual coupling between the reader multi-coil and the tag coil, especially for the perpendicular configuration.

The voltage of the TLA input port is, therefore, the sum of the voltages at the terminals/ports of each sub-coil (*internal resistances are neglected in the expression for the clarity*)

$$\begin{aligned} V_0 &= j\omega(L_1 + L_2 + 2M_{12})I_0 + j\omega(M_{13} + M_{23})I_3 \\ V_3 &= j\omega L_3 I_3 + jM_{eq}I_0 \end{aligned}$$

where M_{eq} is the total equivalent mutual inductance of the system such as $M_{eq} = M_{13} + M_{23}$. The proposed multi-loops reader antenna (MTLA), as shown in Fig. 4, corresponds to two juxtaposed TLA.

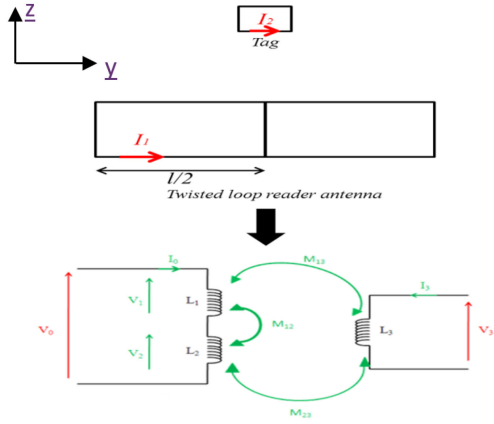

Fig. 3 Electrical model of the TLA reader and the tag

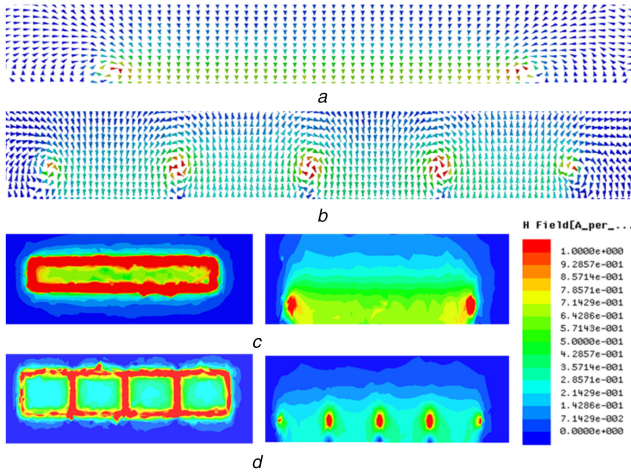

Fig. 4 Field lines, in vertical plane (top) and magnitude of the magnetic field, in horizontal plane, for the two coils structures (i) Conventional/rectangular coil (a, c) and (ii) Multi-coils (b, d)

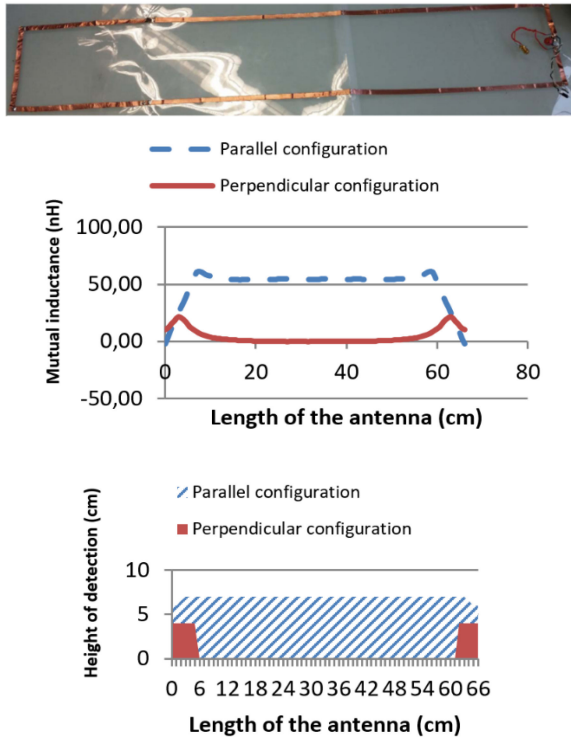

Fig. 5 Mutual inductance (a) Distance of detection and (b) for conventional rectangular antenna in parallel and perpendicular configuration of the tag

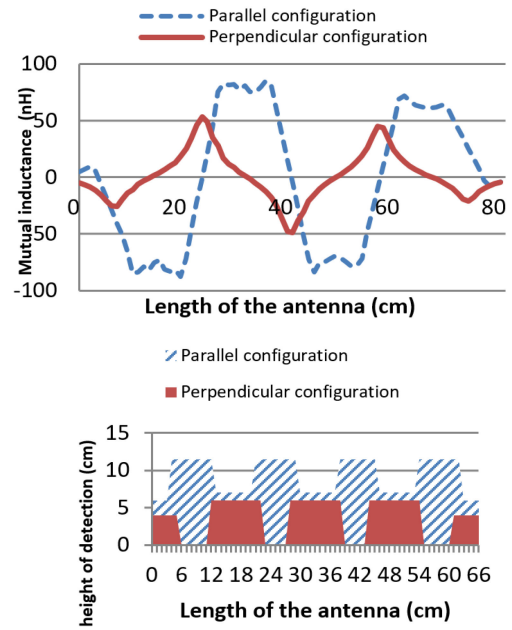
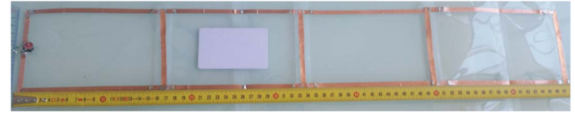

Fig. 6 Mutual inductance (a) Distance of detection and (b) for MTLA in parallel and perpendicular configuration of the tag

3 Coplanar designs

The proposed system in Fig. 1 is made of three parts, each of them being a four sub-coils structure of ($10 \times 16.5 \text{ cm}^2$, four times) which is studied in this section. The size ratio between the tag coil and a conventional (reference) rectangular reader coil of ($10 \times 66.2 \text{ cm}^2$) is 6.7%, while in the multi-coils structure, the tag coil corresponds to 27% of each one of the sub-coil size.

We validate the concept of multiple coils by performing HFSS simulations for two reader coils structures of the same surface: the conventional rectangular one and the four multi-coils, labelled MTLA, in order to demonstrate an improvement concerning mutual inductance values whatever the tag position and orientation.

In an MTLA structure, is based on the complementary coils principle implies the current of each sub-coil to be reversed, i.e. out-of-phase. This leads to the modification of the orientation of the magnetic field lines, especially above the common edge between two juxtaposed sub-coils, as shown in Figs. 5a and b.

The conventional/rectangular coil presents low intensity of the magnetic field into the delimited coil surface while several maxima are obtained not only above the external edges, but especially above the common edge of consecutive sub-coils of the MTLA, as observed in Fig. 4d (right). The tag coil can be arbitrarily positioned and orientated in our context. To characterise the ability of a reader coil structure to efficiently detect such a tag, we study the two orthogonal positions, horizontal (parallel mode) and vertical (perpendicular mode), as an orthonormal basis for any position.

The electrical characteristics of the rectangular coil are a resistance, r , of 1.7Ω and a self-inductance, L , of $1.36 \mu\text{H}$. The MTLA internal resistance is $r = 9.34 \Omega$ and its inductance $L = 2.53 \mu\text{H}$. We compute the mutual inductance between the two reader coils structures and a tag, which is a commercial card simulated by a rectangular coil of $7.8 \times 5.7 \text{ cm}^2$. The tag coil characteristics are $r = 0.25 \Omega$ and $L = 0.21 \mu\text{H}$. Results are reported in Figs. 5 and 6 at a distance of 1 cm. Tag detection results are in Fig. 5b and in Fig. 6b for the two defined modes.

Above the rectangular antenna, at 1 cm, we notice maximum values of mutual inductance above the external edges for both configurations of the tag (Fig. 5a), while over the surface of the antenna the mutual inductance has a constant value: 55 nH in a

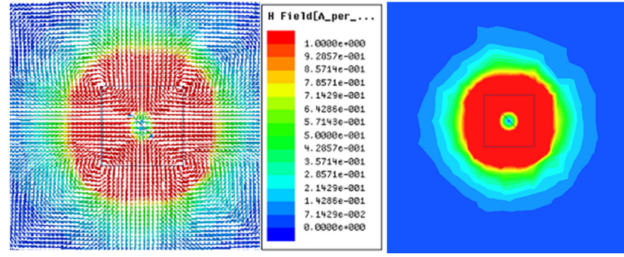

Fig. 7 Lines (left) and magnitude (right) of the magnetic field of the cube (vertical plane, perpendicular to the tube axis)



Fig. 8 Realized 3D design [13] with the tag inside the tube (top), parallel to the tube section (bottom left), and perpendicular to the edges of the tube (bottom right)

parallel configuration and zero in the perpendicular one. RFID read-out distance is correlated with the behaviour of the mutual inductance: the tag is detected at a distance of 7 cm over the rectangular surface in a parallel configuration, while it is detected only above the edges at a distance of 4 cm (Fig. 5).

As shown in Fig. 6, the mutual inductance is improved by the multi-loops reader antenna (MTLA) in both parallel and perpendicular configurations. The maximum values are seen above the common zones between two juxtaposed sub-coils, while the range detection is increased up to 11.5 cm in a parallel configuration and up to 6 cm in a perpendicular configuration, as shown in Fig. 6b.

4 3D design

From the planar design (MTLA) results, the detection in both parallel and perpendicular configurations is improved in comparison with the conventional antenna. To avoid the zones of zero detection in the case of perpendicular configuration the 3D structure is proposed in this part. This structure is compliant with the final requirement of animal tracking described in the first part. A theoretical approximation is made with a cube simulation and a practical detection test is performed thanks to a tube on which the sub-coils are conformed. In previous work [13], a tag card was used in simulation and measurements. The main goal of this part is to ensure detection in all angular orientations of the tag. Secondly, in this work, a smaller tag is used to perform detection measurements for the misaligned tag as proposed in the context of animals tracking.

The display of the theoretical magnetic field in the perpendicular plane to the axis, shown in Fig. 7, shows its circular orientation between the neighbouring coils above the common edge. Concerning the sub-coils in direct visibility, the field lines are directed inwards (sub-coils 2 and 4) or outside the tube (in coils

1 and 3) (Fig. 7a) while the magnitude of the field has a maximum value around the tube edge and a minimum at its centre (Fig. 7b).

For practical tests, the detection structure is made by wrapping the MTLA antenna around a Plexiglas tube of 20 cm diameter. Contrary to the performance of the planar four complementary sub-coils antenna which includes null of detection zones according to the configuration of the card tag, the proposed 3D structure allows the detection of the tag inside the tube in all angular orientations ($0^\circ < \theta < 360^\circ$) (Fig. 8a) except at the centre (on the axis). Outside the tube, the maximum detection distance separating the tag from the antenna structure is 25 cm when the tag is parallel to the tube and 19.5 cm when it is perpendicular to the edges of the tube (Figs. 8b and c). Furthermore, inside the tube, the detection is also performed when the tag is parallel to the concave surface of the tube. Therefore, the design maximises the range detection. These results have been partially presented in [13] and the novelty here is to combine the sub-coils structure in 2D and to add resonators in each of the sub-coils.

In Fig. 1, the structure of the tube corresponds to three juxtaposed cubes. This can be seen as a 3D design with three parts, all of which is four faces conformed design. The principle of current in out of phase is applied for each juxtaposed sub-coils in the design and taking into account the phase of the sub-coils of the other part. To ensure the detection inside the tube, we proposed to use coupled resonators inside sub-coils to detect smaller misaligned tags, for example, commercial disc tags with the tag of 2 cm radius. The use of such this structure with resonators and additional electrical parameters, by means of resonators loads, provide a diversity of B -field orientations inside the volume of detection.

First, one face of the cube is studied and corresponds to a multi-coil line structure (three sub-coils of $10 \times 16.6 \text{ cm}^2$). We have seen previously [10–13] that MTLA improved the detection ability rate for a card tag. However, for the intended applications we need to consider smaller tags due to the size of the animals. As the detection ability is also due to the technological performances of RFID chip, we can just consider herein the fact that the detection will be improved if the mutual inductance can be maximised at several areas, inside the volume of detection, i.e. above the surface of the planar coils equivalent structure. Additionally, the displacement of the tag will help in considering the probability for the tag to be positioned at these optimum areas.

To improve the detection performances of our structures, resonators are added at the centre of each one of the three $16.6 \times 10 \text{ cm}^2$ sub-coil, as shown in Fig. 9. Consequently, the B -field distribution will be modified and the mutual inductance expression will be modified by the resonator parameters. All the resonators ($80 \times 57 \text{ mm}^2$) have the same electrical properties, especially a quality factor of 58. The principle of mutual inductance modification is explained in Fig. 9 where the function ' K ' is the ratio which links the feeding current to the resonator coil current. ' K ' is a function of the inductance and mutual coupling between the feeding coil and the resonator coil, and also the resonator tuning. Herein, the tuning is done at the operating frequency (13.56 MHz).

The prototype is home-made and the mutual inductances for the two configurations of receiving loop (corresponding to the tag without the chip), are measured. The behaviour and the levels of the simulated mutual inductance are completely in accordance with the Vector Network Analyser measurements for both

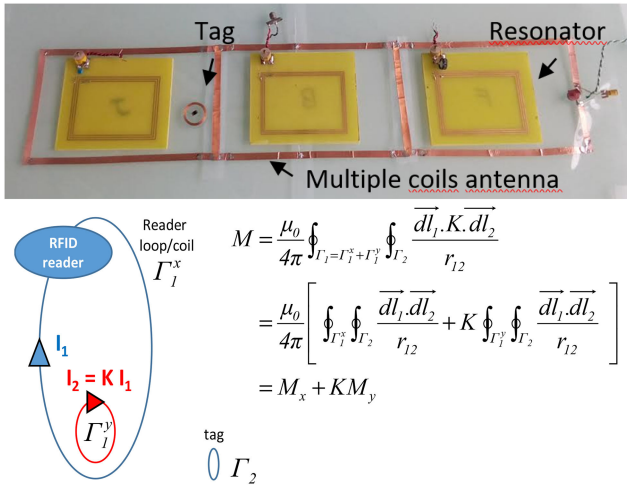

Fig. 9 Proposed multi-coils antenna ($166 \times 100 \text{ mm}^2$) including additional resonators ($80 \times 57 \text{ mm}^2$). Principle of the mutual inductance modification due to the presence of a resonator coil

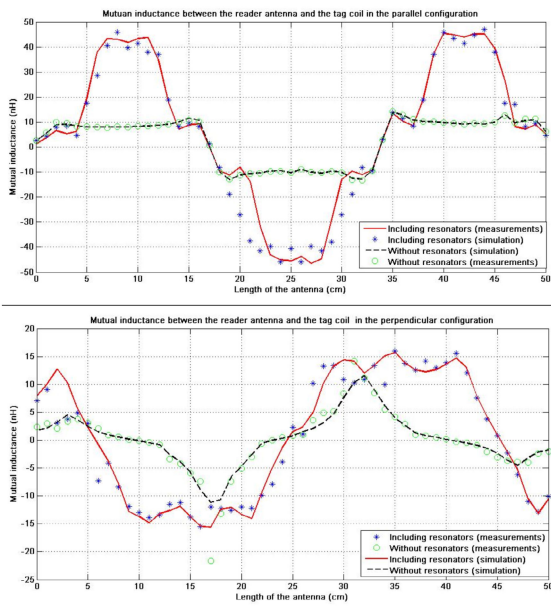

Fig. 10 Equivalent mutual inductance with and without resonators in (a) Parallel and (b) Perpendicular configurations

configurations, as shown in Fig. 10, except for the perpendicular configuration without the resonator. For lateral misalignments, the addition of the resonators increases the mutual inductance up to 30 nH in the parallel configuration above each sub-coil. In the perpendicular configuration, the peak of mutual inductance is improved up to 8 nH at the external edges of the antenna and up to 5 nH at the common edge of the sub-coils (edges of resonators). Several maxima appear above the common edge, with and without the resonators, in the perpendicular configuration. The surface where the mutual inductance seems sufficient for a tag detection is wider in that configuration when using resonators, in detriment of the mutual inductance peak value.

The prototype was connected to a commercial (Ib technology) reader to evaluate the small tag detection in both configurations versus the lateral misalignment and distance between the tag and the reader antenna (Fig. 11).

As seen previously the resonator corresponds to 27% of the sub-coil surface, the tag detection range (volume and surface) has been optimised in its two spatial orientations. Based on the results of Fig. 11, the reading surface was increased up to 18%, from 70% without resonator to 88% with resonators, in parallel configuration with a maximal distance of detection in the centre of the resonators (4 cm), and up to 29%, from 16% without resonator to 45% with resonators, for the perpendicular configuration with a maximal

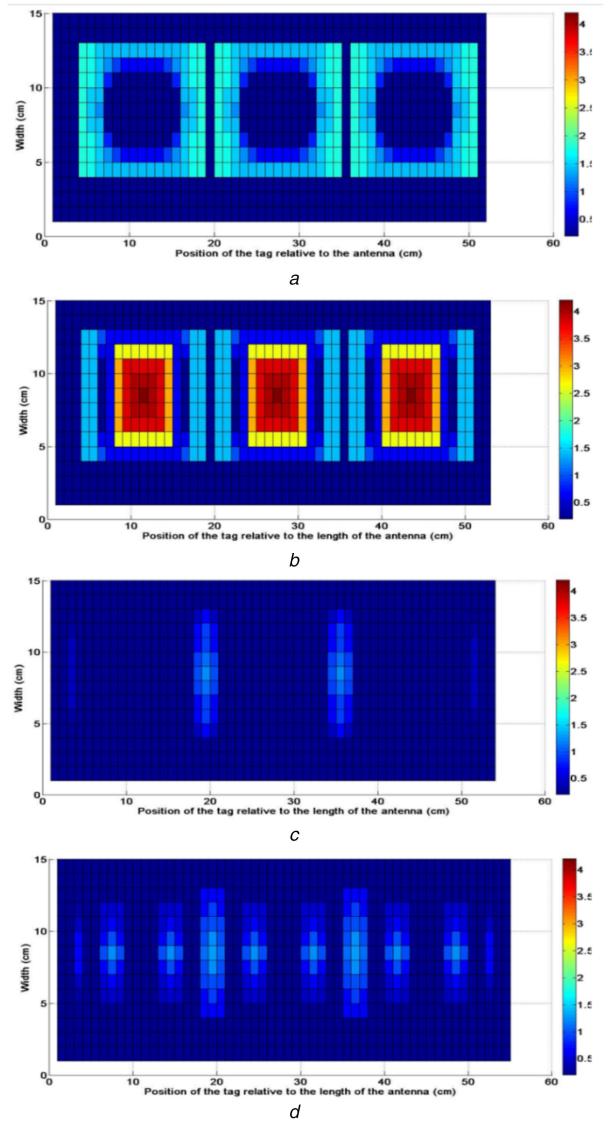

Fig. 11 Detection range results (height of detection) in Parallel configuration with (b) and without (a) resonators and perpendicular configurations with (d) and without (c) resonators

distance of detection on the edges of the sub-coils and resonators (1.3 cm).

These experimental results confirm the improvement of the mutual inductance values over a volume that contributes to creating new detection zones thanks to the added resonators in the centre of the sub-coils.

5 Conclusion

3D HF RFID coils structure allows changing the distribution of the magnetic field to enhance the inductive coupling with an arbitrary oriented small transponder (tag) in a volume. This field orientation diversity is especially fruitful in the case of a moving tag. A magneto-dynamic software was used, respectively, to observe B -field distributions and to calculate the mutual inductance between the reader and the tag. The achievement of good tag detection performances has been realised thanks to an RLC resonator inside each one of the sub-coils of an MTLA structure, for small circular tags. Using the resonators enables also to modify the magnetic field distribution (magnitude and phase) created by the combination of each sub-coil contribution. These new degrees of freedom bring some new optimisation possibilities concerning the detection performances.

Future work will focus on the realisation of the 3D structure combining weakly-coupled resonators, with possible different mistuning, in each complementary sub-coil, conformed on the external surface of the cylindrical tube. Several overlapping 3D

structures could be associated with the tube to avoid the null zone of detection.

6 References

- [1] Finkenseller, K.: '*RFID handbook: radio-frequency identification fundamentals and application*' (Wiley, New York, 2003, 2nd edn.)
- [2] Mirbozorgi, S., Bahrami, H., Sawan, M., *et al.*: 'A smart cage with uniform wireless power distribution in 3D for enabling long-term experiments with freely moving animals', *IEEE Trans. Biomed. Circuits Syst.*, 2016, **10**, (2), pp. 424–434
- [3] Fotopoulou, K., Flynn, B.W.: 'Wireless power transfer in loosely coupled links: coil misalignment model', *IEEE Trans. Magn.*, 2011, **47**, (2), pp. 416–430
- [4] Waters, B.H., Mahoney, B.J., Lee, G., *et al.*: 'Optimal coil size ratios for wireless power transfer applications'. IEEE Int. Symp. on Circuits and Systems (ISCAS), 2014, pp. 2045–2048
- [5] Kamineni, A., Covic, G.A., Boys, J.T.: 'Analysis of coplanar intermediate coil structures in inductive power transfer systems', *IEEE Trans. Consum. Electron.*, 2015, **30**, (11), pp. 6141–6154
- [6] Hwang, H., Moon, J., Lee, B., *et al.*: 'An analysis of magnetic resonance coupling effects on wireless power transfer by coil inductance and placement', *IEEE Trans. Consum. Electron.*, 2014, **60**, (2), pp. 203–209
- [7] Ahmed, M.Y., Mohan, A.S.: 'Multi-loop Bridge antenna for improved positioning using HF RFID'. Asia-Pacific Microwave Conf., 2011
- [8] Hirayama, H., Satake, Y., Kikuma, N., *et al.*: 'Improvement of null zone avoidance capability for HF-band RFID using diversity combining of loop antennas'. European Conf. Antennas and Propagation, 2009, pp. 1594–1597
- [9] Gong, S.-Y., Xie, G.J.: 'Three overlapping loop antennas for 3D RFID. 13.56 MHz access control gate', *Int. J. Comput. Theory Eng.*, 2012, **4**, (3), pp. 358–361
- [10] Shi, X., Smith, J.R.: 'Large area wireless power via a planar array of coupled resonators'. Int. Workshop on Antenna Technology (iWAT), March 2016, pp. 200–203, DOI: 10.1109/iWAT.2016.7434842
- [11] Choi, B.H., Lee, E.S., Sohn, Y.H., *et al.*: 'Six degrees of freedom mobile inductive power transfer by crossed dipole Tx and Rx coils', *IEEE Trans. Power Electron.*, 2016, **31**, (4), pp. 3252–3272, DOI: 10.1109/TPEL.2015.2449290
- [12] Benamara, M., Grzeskowiak, M., Diet, A., *et al.*: 'Twisted loop antenna for HF RFID detection surface'. European Conf. Antennas and Propagation, 2016, pp. 1–5
- [13] Benamara, M., Grzeskowiak, M., Salhi, M., *et al.*: '3D HF RFID reader antenna for Tag detection in different angular orientations'. Loughborough Antennas & Propagation Conf., 2016
- [14] Diet, A., Grzeskowiak, M., Le Bihan, Y., *et al.*: 'Improving LF reader antenna volume of detection for RFID token tag thanks to identical coaxial loops (ICLs) and in/out-of phase multiple-loops structures'. IEEE Int. Conf. RFID-Technology and Applications, 2014