



HAL
open science

A Twisted Loop Antenna to enhance HF RFID detection for different tag positioning

Megdouda Benamara, Marjorie Grzeskowiak, Antoine Diet, Gaelle Bazin
Lissorgues, Yann Le Bihan, Stéphane Protat, Christophe Conessa

► **To cite this version:**

Megdouda Benamara, Marjorie Grzeskowiak, Antoine Diet, Gaelle Bazin Lissorgues, Yann Le Bihan, et al.. A Twisted Loop Antenna to enhance HF RFID detection for different tag positioning. 2016 10th European Conference on Antennas and Propagation (EuCAP), Apr 2016, Davos, Switzerland. pp.1-5, 10.1109/EuCAP.2016.7481810 . hal-01691587

HAL Id: hal-01691587

<https://centralesupelec.hal.science/hal-01691587>

Submitted on 31 Jul 2019

HAL is a multi-disciplinary open access archive for the deposit and dissemination of scientific research documents, whether they are published or not. The documents may come from teaching and research institutions in France or abroad, or from public or private research centers.

L'archive ouverte pluridisciplinaire **HAL**, est destinée au dépôt et à la diffusion de documents scientifiques de niveau recherche, publiés ou non, émanant des établissements d'enseignement et de recherche français ou étrangers, des laboratoires publics ou privés.



Open Archive Toulouse Archive Ouverte (OATAO)

OATAO is an open access repository that collects the work of some Toulouse researchers and makes it freely available over the web where possible.

This is an author's version published in: <https://oatao.univ-toulouse.fr/24086>

Official URL : <https://doi.org/10.1109/EuCAP.2016.7481810>

To cite this version :

Benamara, Megdouda and Grzeskowiak, Marjorie and Diet, Antoine and Lissorgues, Gaëlle and Le Bihan, Yann and Protat, Stéphane and Conessa, Christophe A Twisted Loop Antenna to enhance HF RFID detection for different tag positioning. (2016) In: 2016 10th European Conference on Antennas and Propagation (EuCAP), 10 April 2016 - 15 April 2016 (Davos, Switzerland).

Any correspondence concerning this service should be sent to the repository administrator:

tech-oatao@listes-diff.inp-toulouse.fr

A Twisted Loop Antenna to Enhance HF RFID Detection for Different Tag Positioning

Megdouda BENAMARA¹, Marjorie GRZESKOWIAK¹, Antoine DIET², Gaëlle LISSORGUES³, Yann LE BIHAN², Stéphane PROTAT¹, Christophe CONESSA²

¹Univ Paris-Est, ESYCOM (EA 2552), UPEMLV, ESIEE-Paris, CNAM, F.77454 Marne-la-Vallée, France

²Univ. Paris Saclay, GeePs (UMR 8507), CNRS, CentraleSupélec, Univ. Paris Sud, UPMC) 91192 Gif-sur-Yvette, France

³ESIEE-Paris, ESYCOM (EA 2552), UPEMLV, ESIEE-Paris, CNAM, Cite Descartes, BP99, 93162 Noisy le Grand

Abstract—In this paper, a new LF/HF RFID reader loop antenna design is proposed and tested, in order to increase detection areas of the tags. The studied structure is a Twisted Loop Antenna (TLA) which is based on a modified distribution and orientation of the magnetic field lines. Our structure fruitfully uses the complementary antenna principle in a coplanar configuration. This offers more possibilities of tag detection whatever the tag position and orientation. The antenna performances are evaluated by optimizing the equivalent mutual inductance between reader antenna and tag antenna. Results are presented firstly in simulation (MATLAB and HFSS electromagnetic calculator) and secondly by experimental tests at different distances and misalignments, for the two possible tag orientations: parallel and perpendicular.

Index terms: Mutual inductance, LF / HF RFID, loop antenna, co-planar configuration, coupling optimization

I. CONTEXT

RFID by magnetic coupling, in LF (125-134 kHz) and HF (13,56 MHz), is a mature technology nowadays. However, the radiofrequency link based on magnetic mutual coupling between reader and tag antenna, often loops antenna, is still a complex challenge to improve the system. Detection range and areas are considered an assessment factor for RFID system performances [1][2]. The detection of the tag is performed when its effective surface has generated enough power to supply the RFID tag chip, by integrating the magnetic field generated by the reader loop current. This is maximized when the effective surface is perpendicular to the magnetic field. As the detection is depending on the generated magnetic field, the reader structure can present many null areas detection versus the possible orientations of the tag (fig.1).

In this paper we focus on two configurations, parallel ($\theta=0^\circ$) and perpendicular ($\theta=90^\circ$), corresponding respectively to the best and the worst geometrical configuration between the reader and the tag loops in the case of RFID detection. Some studies were proposed in the literature optimizing the mutual coupling between the reader and the tag by changing either the sizes of antennas or their geometrical structures

from a mono-layer loop to multi layer loops [3][4][5][6][7] in the parallel configuration. However such studies did not solve the question of detection with a mono-layer 2D structure with other configurations, especially perpendicular configuration. Our idea is to change the distribution and the orientation of the magnetic field generated by the reader antenna by modifying the path of the feeding current in the reader loop. Therefore, we propose a “twisted loop antenna” (TLA) that is a mono-layer 2D structure allowing a maximum of field in both edge and center of the reader, especially in the perpendicular orientation (fig.2a).

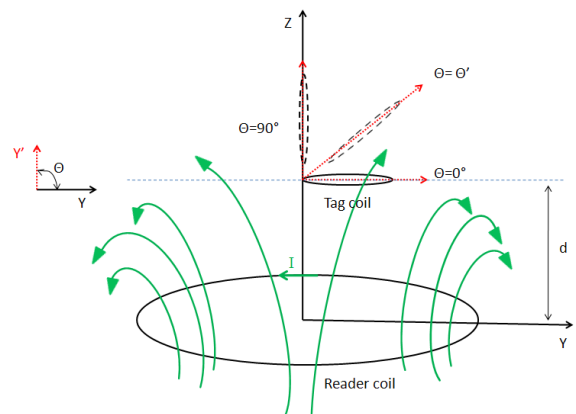

Fig.1: Different positioning of a RFID tag

We focus on the mutual inductance, M , which is a good figure of merit for evaluating the performance of the proposed antenna in the case of weak coupling. The enhancement of detection areas and volume of the TLA, due to the maximization of M , is done by comparison with a classical rectangular loop for both parallel and perpendicular configurations.

II. CLASSICAL ANTENNA AND TLA DESIGN

The loop antenna structures were simulated with the electromagnetic software HFSS (High Frequency Structural Simulator) and compared with analytical calculation thanks to Matlab. Surfaces of the loops were respectively 200cm^2 and 128cm^2 for the rectangular reference and the TLA. Their

electrical and geometrical characteristics are presented in table 1 / fig 2a, where L and r are respectively proportional to the imaginary and the real part of the input impedance.

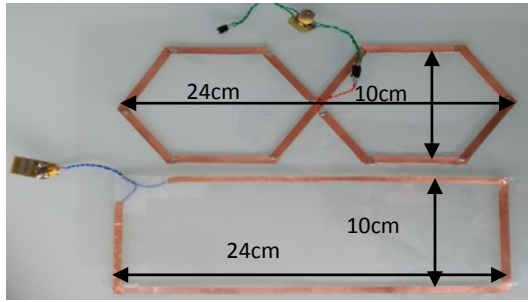

Fig.2a: Loop antenna (bottom) and TLA (top)

The simulated loops are designed without substrate and with Perfect- Electrical-Conductor (PEC), while for the fabricated corresponding structures, copper ribbons (0.017mm thick) are stuck on a plastic sheet.

Tab1: Electrical characteristics of studied antennas

	rectangular-loop	TLA	TAG
Inductance 'L'	47.85nH	49.29nH	5.79nH
Resistance 'r'	0.20Ω	0.23Ω	5.62Ω

So, the objective is to maximize the mutual inductance between the reader loop (rectangular or TLA) and the tag loop while keeping constant the global size of the reader antenna. Also, the reader antennas present a relative difference inferior to 5% for the self-inductance value and less than 2% for the resistance.

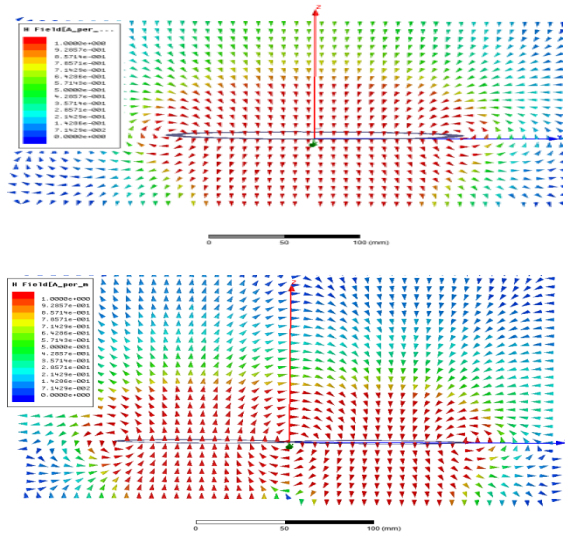

Fig.2.b.Magnetic field distribution for classical loop antenna (top) and TLA (bottom) for a scale of 0 to 1 A/m

The repartition of the magnetic field of the TLA is similar to the one obtained with two juxtaposed circular loops

separated by a distance of 5mm. The magnetic field lines (fig.2.b) are oriented parallel to the structure in the center and on the edges, so the TLA could detect TAGs oriented perpendicularly to the reader antenna in several zones, contrary to the case of a loop antenna where the tag can only be detected on the edges.

Therefore the TLA offers more possibilities of detection thanks to the repartition and orientation of its field. In the next part of this work, we confirm the validity of the proposed TLA reader structure by calculating the mutual inductance as required comparing with HFSS simulation and experimental results.

III. THEORETICAL STUDY

We investigated the calculation of the mutual inductance by using the electrical model in fig. 3, where L_1, M_{12} in series with L_2, M_{21} represent the two sub loops of the TLA.

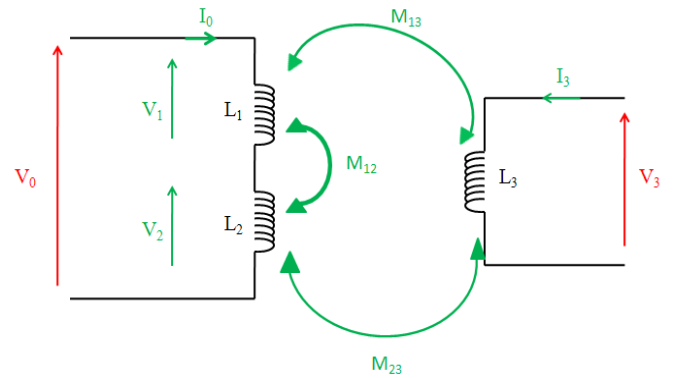

Fig.3. Electrical model for the TLA (left) and a tag (right)

As the twisted antenna is defined by two coupled inductances in series, the voltage can be written in the harmonic regime (at frequency $\omega = 2\pi f$) as:

$$V_0 = j(L_2 + L_1 + 2 * M_{12})\omega I_0 + j(M_{23} + M_{13})\omega I_3(1)$$

The voltage on the tag is:

$$V_3 = jL_3\omega I_3 + jM_{eq}I_0 \quad (2)$$

Where:

$$M_{eq} = M_{13} + M_{23}$$

The calculation of the mutual inductance under Matlab is based on the magnetic field (B_r, B_θ, B_y) generated by a current I_0 circulation, as defined by (3). The evaluation of M_{eq} is achieved by a numerical discrete integration on a surface corresponding to the reader loop surface and orientation [7][8].

$$\left\{ \begin{array}{l} B_r = \frac{I_0 \mu_0 y}{2\pi[(R+r)^2 + y^2]^{1/2} r} \left[\frac{R^2 + r^2 + y^2}{[(R-r)^2 + y^2]} E(\rho) - K(\rho) \right] \\ B_\theta = 0 \\ B_y = \frac{I_0 \mu_0}{2\pi[(R+r)^2 + y^2]^{1/2} r} \left[\frac{R^2 - r^2 - y^2}{[(R-r)^2 + y^2]} E(\rho) + K(\rho) \right] \\ \rho^2 = \frac{4Rr}{[(R+r)^2 + y^2]} \end{array} \right. \quad (3)$$

Where r corresponds to the distance between the center of the loops and the functions $K(\rho)$ and $E(\rho)$ are the complete elliptic integrals of first and second kind respectively. After discretization of the equation 3, the mutual inductance can be calculated with Matlab. In figure 4, we have presented our structures with the following parametrical studies: variations of the distance dz , of misalignment dy and orientation angle θ .

To simplify the calculus with Matlab we have considered a rectangular $10\text{cm} \times 20\text{cm}$ shape for the classical loop, while the twisted loop can be seen like two juxtaposed square loops separated by a distance of 5mm . For comment, the fabricated TLA is made of two hexagons because of the difficulty of handmade realization of circular loops while the simulated classical loop and TLA have circular shapes. The results of the analytical study are presented in the following part

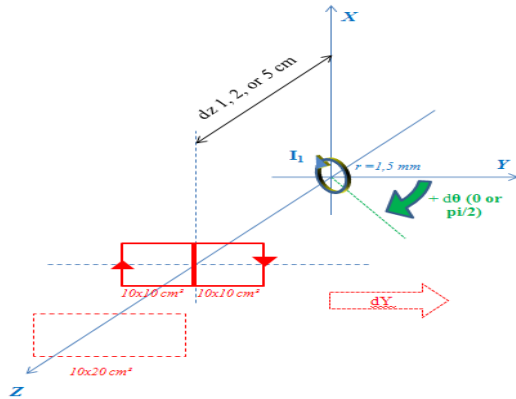
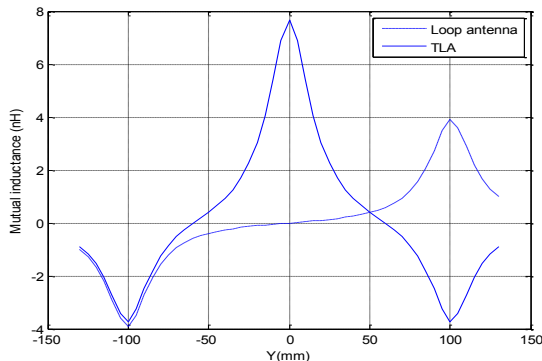
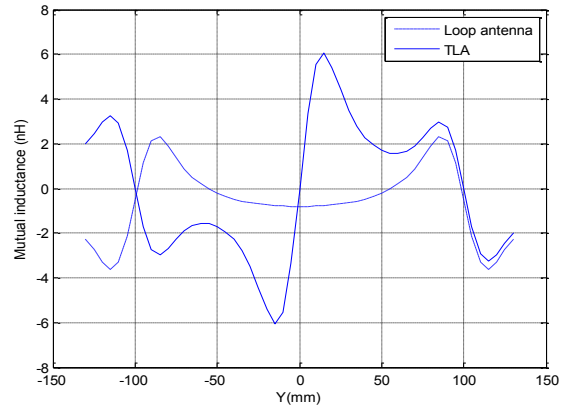

Fig.4. Parametrical studies of the reference loop antenna and TLA

To validate the proposed TLA structure we have to prove its interest compared to the classical loop in both perpendicular and parallel configurations as seen in figure 5.



(a)



(b)

Fig.5. Loop antenna and TLA for lateral misalignment in perpendicular (a) and perpendicular (b) configuration (Matlab calculation)

The TLA improves the mutual inductance, especially in perpendicular configuration (fig.5 (a)), where the mutual inductance has three maxima: 8nH at the center and 4nH at the edges of the TLA instead of a zero in the classical loop at its center and 4nH at its edges (only two maxima). For parallel configuration (fig.5(b)), the mutual inductance is also improved at the close surface of the antenna where we have 6nH around the center and 3nH at the edges.

IV. HFSS SIMULATION AND MEASUREMENTS

The antennas presented in figure 2 were studied using HFSS and fabricated by sticking copper ribbons on plastic sheet. Measurements were realized with a Vectorial Network Analyzer N9923A (fig.6). The tag antenna is a circular loop with 30mm of diameter.

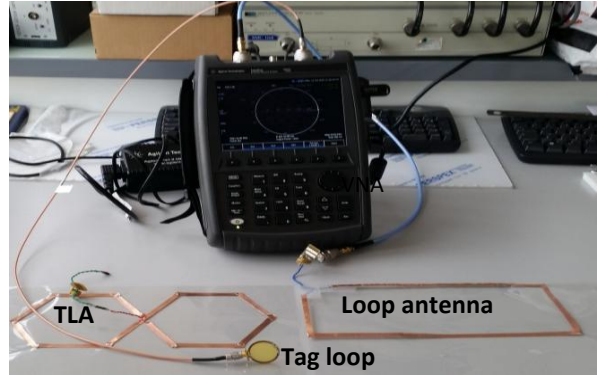

Fig.6 Experiment setup

A. Comparison of HFSS simulation versus measurements for both loop antenna and TLA

As explained in introduction, the performance of RFID detection is based at first glance on the evaluation of mutual inductance between the reader and the tag, as the coupling is

weak in practice. For all comparisons, the distance between the loop and the tag is 10mm.

In the case of perpendicular configuration, in both measurement and simulation, the TLA has three maxima of mutual inductance (absolute values). However, the classical loop has therefore only two maxima of mutual inductance at the edges of the antenna. The results are comparable to the analytical study in figure 5.a. Also, for parallel configuration, the TLA has 4 maxima of mutual inductance corresponding to the edges of the sub-loops and the areas near to their centers. In the case of the classical loop antenna, the mutual inductance has only two maxima corresponding to the edges of the loop (the results are comparable for the Matlab calculation in figure 5.b). In both parallel and perpendicular configurations we can see the symmetrical values at $y=0\text{mm}$ (center of the reader antenna).

The results of simulation are fruitfully confirmed by measurements.

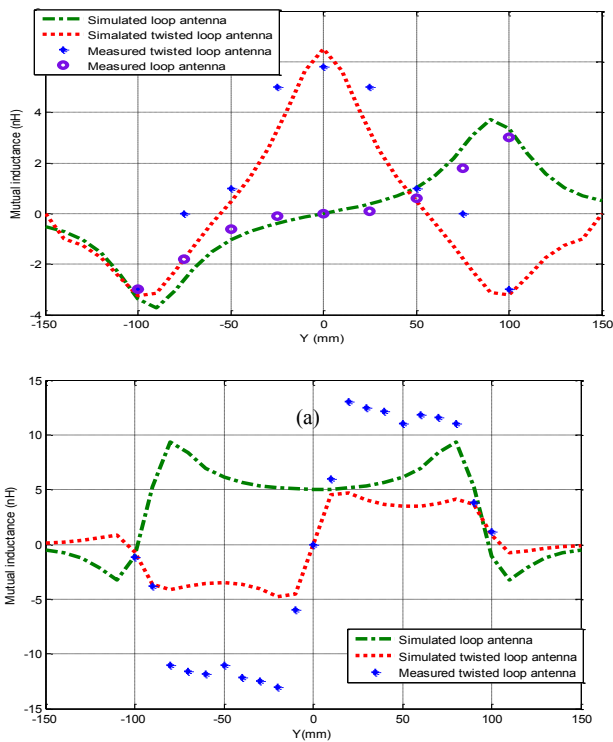

Fig 7. HFSS simulations and measurements for both TLA and rectangular loop antenna in (a) perpendicular and (b) parallel configurations

B. Tag loop distance variation

After validating the advantages of the TLA structure, we focused on the influence of the tag distance on the mutual inductance.

For a lateral misalignment ($-150\text{mm} < y < 150\text{mm}$) and two different tag distances (10mm and 20mm), we plotted in figure 8 the mutual inductance variation in parallel and perpendicular configuration for the TLA, thanks to HFSS.

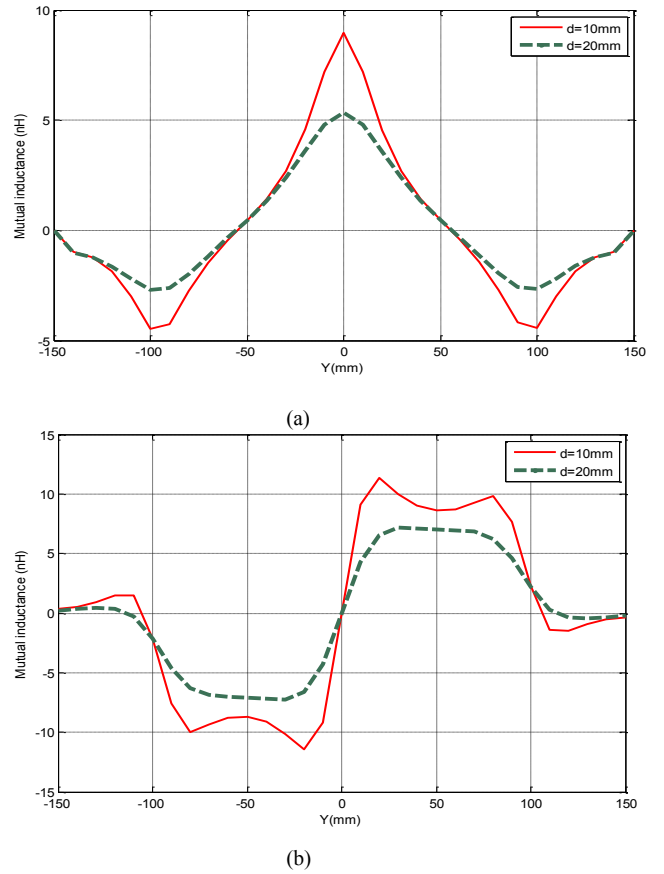

Fig 8 Mutual inductance versus tag-loop distance, (a):perpendicular configuration. (b): parallel configuration (HFSS simulations)

As expected, the mutual inductance decreases with increasing distance between the reader and the tag in both parallel and perpendicular configurations. The degradation is more visible at the edges of reader loop. However, this distance variation has no influence in the position of the areas of minima and maxima of mutual inductance.

V. EXPERIMENTAL VALIDATION

Our objective is to reduce the null areas of detection in both parallel and perpendicular configurations, to later improve objects detection in any configurations. For experimental validation of the TLA, we have used a commercial RFID reader from IB technologies and a tag with 30 mm of diameter (Fig.9).

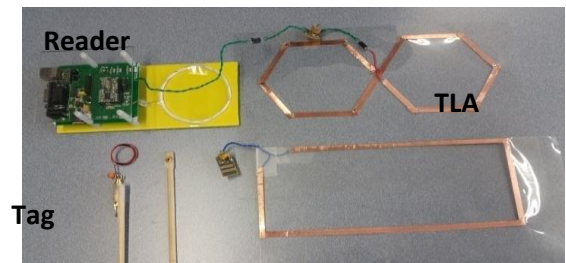

Fig 9. Experimental setup for RFID detection tests

For the rectangular antenna ($20 \times 10 \text{ cm}^2$), the detection was performed at a distance of 2cm around the edges of antenna, for parallel and perpendicular configurations. However, the detection in Fig.10 was increased for distance and surface for both configurations, 2cm at the edges of the TLA and 4cm at the center (The color scale represents the distance of detection).

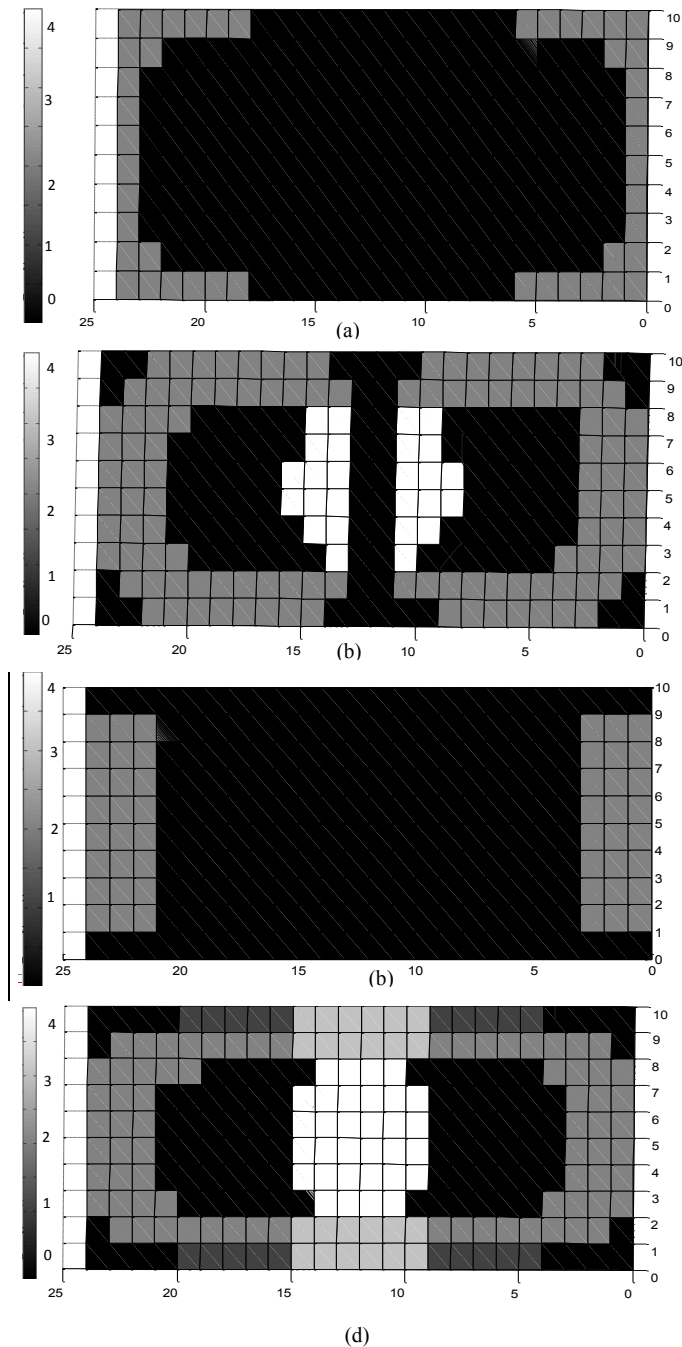

Fig 10. Detection results for:
(a): Loop antenna in parallel configuration
(b): TLA in parallel configuration
(c): Loop antenna in perpendicular configuration
(d): TLA in perpendicular configuration

VI. CONCLUSION

In this paper we have developed and designed a new reader twisted loop antenna, TLA, for RFID applications. The TLA is based on a modified distribution of the magnetic field, as in the case of co-planar complementary loops. The TLA was compared with a classical rectangular loop with the same electrical and geometrical characteristics. The interest of the proposed structure is evaluated according to the improvement of the mutual inductance in function of the tag orientation and a lateral misalignment. Simulations results and measurements showed that the TLA structure potentially improves both distance and surface of detection by locally maximizing the mutual inductance with a tag loop.

Additionally tests of small tags detection with a commercial RFID HF reader confirm that TLA has a higher total detection area and volume than the classical rectangular loop.

In the future, the TLA will be used for detecting simultaneously many tags in different angular and distance positioning.

References

- [1] W. Kwon, Y.-G.Gim, H.Park ,S.Kim, a magnetic resonant loop to enhance the operating distance of 13.56 MHz RFID system, ,IEEE ISOCC, , pp. 013 – 014, 2013.
- [2] M. Grzeskowiak, A. Diet, P. S. Diao, S. Protat, C. Bourcier, Y. Le Bihan, G. Lissorgues. Pebbles Tracking Thanks to RFID LF Multi-loops Inductively Coupled Reader. Progress In Electromagnetics Research, PIER C, ISSN: 1937-8718, Vol. N°55, pp. 129-137, 2014.
- [3]K.D'hoel,J.Goemaere,N.Stevens,B.Nauwelaers,L.Strycker ,Automated Design of an HF RFID Loop AntennaBased on Parametric Geometry Modification, IEEE International Conference on RFID:, Page(s): 1 – 7, 2014.
- [4]Hiroshi Hirayama, Yu Satake, Nobuyoshi Kikuma, KunioSakakibara ,Improvement of Null Zone Avoidance Capabilityfor HF-band RFID using Diversity Combiningof Loop Antennas, EuCAP, pp. 1594 – 1597, 2009
- [5] A. A. Eteng, S. K. A. Rahim, C. Y. Leow, M. I. Sabran, M. F. M. Yusof, Loop Antenna Design for Lateral H-Field Uniformity in Misaligned HF-RFID Links, IEEE ISWTA , pp. 92 – 95, 2014.
- [6]S.I.Babic, F.Sirois, C.Akyel, Validity check of mutual inductance formulas for circular filaments with lateral and angular misalignments, Progress in Electromagnetics Research, Vol.8, pp.15-26, 2009
- [7] M.Grzeskowiak,F.ElHatmi, A.Diet, Me Benamara, D.Delcroixa, T.Alvesa, S.Protata, S.Mostarshedia, O.Picon, Y.Bihanb,1, G.Lissorguesa, Coils for ingestible capsules: Near-field magnetic induction link, Comptes Rendus Physique, Vol 16, pp. 819–835, 2015.
- [8] A .Diet, M.Grzeskowiak, Y.LeBihan, C.Conessa, Improving LF Reader Antenna volume of detection, for RFID token tag, with a combination of ICLs and in/out-of phase multiple-loops structures, IEEE RFID-TA, , 208-213, 2014.