



HAL
open science

Reader antenna including resonators for HF RFID detection

Megdouda Benamara, Marjorie Grzeskowiak, Gaelle Bazin Lissorgues, A. Diet, Yann Le Bihan, Christophe Conessa

► **To cite this version:**

Megdouda Benamara, Marjorie Grzeskowiak, Gaelle Bazin Lissorgues, A. Diet, Yann Le Bihan, et al.. Reader antenna including resonators for HF RFID detection. 2016 Loughborough Antennas & Propagation Conference (LAPC), Nov 2016, Loughborough, United Kingdom. pp.1-5, 10.1109/LAPC.2016.7807592 . hal-01691605

HAL Id: hal-01691605

<https://centralesupelec.hal.science/hal-01691605v1>

Submitted on 31 Jul 2019

HAL is a multi-disciplinary open access archive for the deposit and dissemination of scientific research documents, whether they are published or not. The documents may come from teaching and research institutions in France or abroad, or from public or private research centers.

L'archive ouverte pluridisciplinaire **HAL**, est destinée au dépôt et à la diffusion de documents scientifiques de niveau recherche, publiés ou non, émanant des établissements d'enseignement et de recherche français ou étrangers, des laboratoires publics ou privés.



Open Archive Toulouse Archive Ouverte (OATAO)

OATAO is an open access repository that collects the work of some Toulouse researchers and makes it freely available over the web where possible.

This is an author's version published in: <https://oatao.univ-toulouse.fr/24079>

Official URL : <https://doi.org/10.1109/LAPC.2016.7807592>

To cite this version :

Benamara, Megdouda and Grzeskowiak, Marjorie and Lissorgues, Gaëlle and Diet, Antoine and Le Bihan, Yann and Conessa, Christophe Reader antenna including resonators for HF RFID detection. (2016) In: 2016 Loughborough Antennas & Propagation Conference (LAPC), 14 November 2016 - 15 November 2016 (Loughborough, United Kingdom).

Any correspondence concerning this service should be sent to the repository administrator:

tech-oatao@listes-diff.inp-toulouse.fr

Reader Antenna Including Resonators for HF RFID Detection

M. BENAMARA ,M. GRZESKOWIAK., G.
LISSORGUES

ESYCOM EA 2552 (UPEMLV, ESIEE-Paris, CNAM)
Cite Descartes, F. 77454 Marne-la-Vallée, France
benamara@univ-mlv.fr

A. DIET, Y. LE BIHAN, C.CONESSA
GEEPS (PIEM) UMR 8507, Univ. Paris Saclay
F. 91192 Gif sur Yvette, France

Abstract—In this article, HF RFID reader antenna including small resonant coil, operating with the magnetic coupling with the reader coil, is reported. The proposed system is used to improve surface and volume of small tag detection. The performances of such system are validated by maximization of input impedance (load modulation principle) and equivalent mutual inductance between the reader dual-coils and the tag coil compared to a conventional RFID reader antenna. Analytical formulas of these parameters are developed. The proposed system is validated by detection measurements in parallel and perpendicular configurations between the reader and the tag coils.

Index Terms— RFID; magnetic coupling; detection; HF

I. INTRODUCTION

RFID (Radio Frequency Identification) LF (Low Frequency, 125 kHz) and HF (High Frequency, 13.56MHz) is a non-contact technology used to identify objects. The communication is done by load modulation principle between the reader and the tag. Principally, the performances of such system are evaluated according to the range of the tags. In the context of such near field communications, where the magnetic coupling phenomenon is the medium, the range tags depends on the respective sizes between the reader and the tag coils and their spatial orientations[1][2][3].

In the context of small tags identification, both surface and volume of tag detection are limited. Optimizing RFID detection requires the modification of the reader antenna structure on a multi-loop antenna. This solution can be applied in LF, but presents limits in HF application because of the line length of the reader antenna [4][5][6]. Herein, we proposed in this article, a reader antenna including small resonant coil operating with the magnetic coupling with the reader coil. We focus on a “bi-coils prototype” whose performance illustrates the principle. Consequently, the optimization and maximization of communication parameters (mutual inductance and input impedance) is our figure of merit.

The proposed structure seen in Fig.1 consists in inserting a resonator (small co-planar coil), included in the surface of a reader coil. The centers of the two coils are the furthest possible without coil intersection. The structure in Fig.1 represents the interaction between the two reader coils (1 and resonator) and the coil of the tag (2). Coil 2 has a radius of $R_2 = 15$ mm. Coils and the resonator coil present respectively a radius of 50mm and 15mm.

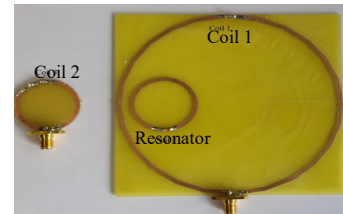

Fig.1. Fabricated tag (coil 2) (left) and dual-coils 1-resonator (right)

Two configurations for the reader and the tag coils were investigated: parallel (0°) and perpendicular (90°) orientations, as defined in Fig.2. In the context of volume detection for any tag orientation, the mutual inductance has to be optimized in both of these cases. Several other geometrical factors are involved in this study such as radii of coils, lateral misalignment and distance between the tag and the reader dual-coils.

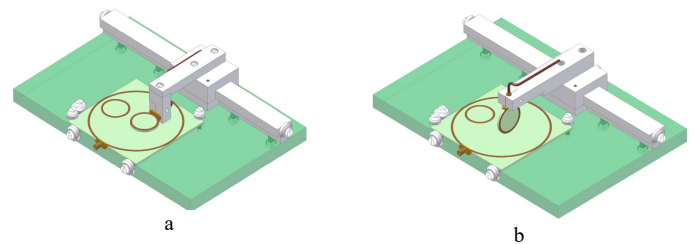

Fig.2. Parallel (a) and perpendicular (b) configurations.

In this study, the volume of detection is approximated by the different parallel surfaces of detection at different height values. Each one of these surfaces, parallel to the plane including the dual-coils structure, is defined as areas where the effective surface of the TAG is perpendicular to the magnetic field generated by the reader [7]. The addition of a resonator concentrates and modifies the vectorial distribution of the

magnetic field generated by the reader, as it can be shown in Fig.3. This increases and decreases locally the mutual impedance in function of the tag coil position. Accordingly, optimal detection areas can appear because a minimum value of mutual induction is needed in order to power the chip of RFID tags.

In the following section of this paper, formulas defining the input impedance and the equivalent mutual inductance are investigated. The formulas are used in HFSS (High Frequency Structure Simulator) simulations results for parallel and perpendicular configurations. The last part exhibits a first optimized HF RFID detection, checking the operation principle, with a matched fabricated prototype constituted of added resonators in a coplanar coil, connected to a commercial RFID module.

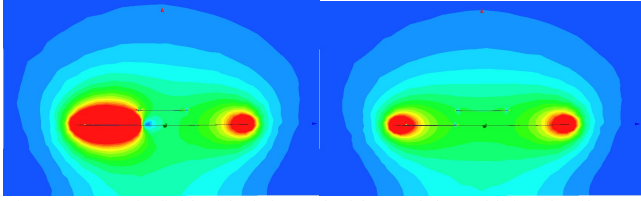

Fig. 3. Magnetic field with (left) and without (right) additional coil resonator

II. EQUIVALENT CIRCUIT FOR RFID SYSTEM INCLUDING RESONATORS

To determinate theoretically the physical parameters between the reader and the tag coils, we use the electrical equivalent model in Fig.4. Inductances and tuning capacitance values at 13.56MHz of the circuit are: $L_1=0.3$ uH, $C_1=0.45$ nF, $L_{res}=0.058$ uH, $C_{res}=2.32$ nF, $L_3=0.058$ uH, $C_3=2.32$ nF. $r_1=0.1\Omega$, $r_{res}=0.06\Omega$, $r_2=0.06\Omega$ are the internal resistances.

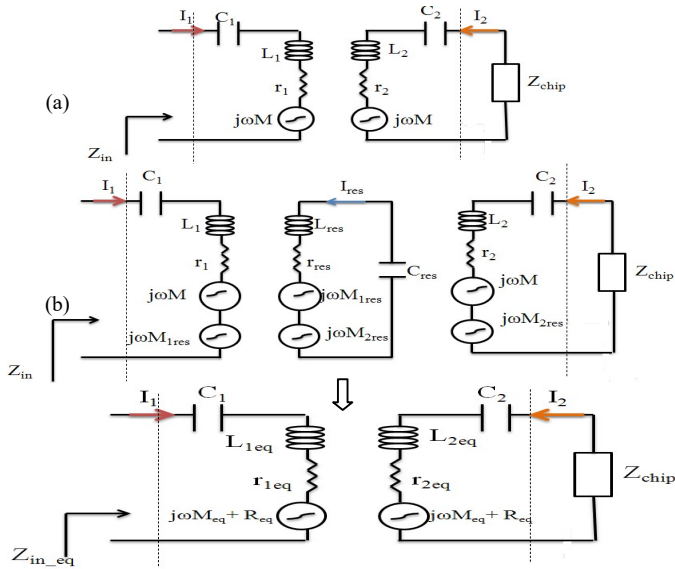

Fig.4. Electrical model for conventional (a) and proposed (b) RFID system.

In conventional system, the link between the tag and the reader is the mutual inductance, while in the proposed system, the reader is two magnetically coupled coils, the link between the reader and the tag depends on the mutual impedance. In This part, we are interesting on the influence of the added resonator on the input impedance and the equivalent mutual impedance; these two parameters are used, later in this paper, to analyze RFID performances.

In conventional structure, the input impedance of the reader coil and the mutual inductance are expressed as:

$$Z_{in} = r_1 + j\omega L_1 + \frac{\omega^2 M^2}{r_2 + j\omega L_2 + Z_{chip}} \quad (1)$$

$$M = \frac{\text{Im}(Z_{12})}{\omega} \quad (2)$$

In the proposed design, all impedance matrix parameters are changed compared to the conventional system:

$$Z_{11_{eq}} = j\omega \left(L_1 - \frac{1}{C_1 \omega^2} + \omega (M_{1res})^2 \gamma \right) + \omega^2 (M_{1res})^2 \delta + r_1 \quad (3)$$

$$Z_{12_{eq}} = j\omega (M + \omega M_{1res} M_{res2} \gamma) + \omega^2 M_{1res} M_{res2} \delta$$

$$Z_{21_{eq}} = j\omega (M + \omega M_{res2} M_{res1} \gamma) + \omega^2 M_{res2} M_{res1} \delta$$

$$Z_{22_{eq}} = j\omega \left(L_2 - \frac{1}{C_2 \omega^2} + \omega (M_{2res})^2 \gamma \right) + \omega^2 (M_{2res})^2 \delta + r_2$$

With

$$\gamma = \frac{\frac{1}{C_{res}\omega} - \omega L_{res}}{\left(\omega L_{res} - \frac{1}{C_{res}\omega} \right)^2 + r_{res}}, \quad \delta = \frac{r_{res}}{\left(\frac{1}{C_{res}\omega} - \omega L_{res} \right)^2 + r_{res}}$$

The resonator influence is depicted in both reader and tag impedances by the M_{1res} and M_{2res} parameters but also by impedance coupling (in this case, the mutual impedance has a real and an imaginary part). The equivalent input impedance and equivalent mutual inductance are then expressed by:

$$Z_{in_{eq}} = Z_{11_{eq}} - \frac{Z_{12_{eq}}}{Z_{22_{eq}} + Z_{chip}} \quad (4)$$

$$M_{eq} = \frac{\text{Im}(Z_{12_{eq}})}{2\pi f} = M_{13} + \omega M_{12} M_{23} \gamma \quad (5)$$

In the next part, the calculated formulas are used for evaluated the performances of the proposed system.

III. EFFECT OF THE ADDED RESONATOR ON (EQUIVALENT) MUTUAL INDUCTANCE

In this part, the interest of adding resonators on the surface of the reader is discussed according to the different radius tag and distance between the reader and the tag coils.

A2. Equivalent Mutual Inductance for Different Radius Tag Values

The evolution of the equivalent mutual inductance is parametrically studied according to the radius of the tag for different cases: two coils, with or without resonator. Fig.5a shows two circular and parallel coils ($R_2 \leq R_1$). They are located at a distance of 10mm. The mutual inductance is evaluated for lateral displacement of the coil 2 along Oy. In this case, the mutual inductance can be shown to be maximal in the center of coil 1 for $R_2 \sim R_1$. For a radius ratio $R_1/R_2 > 5/4$, the maximum of mutual inductance is shown in the edge of coil 1.

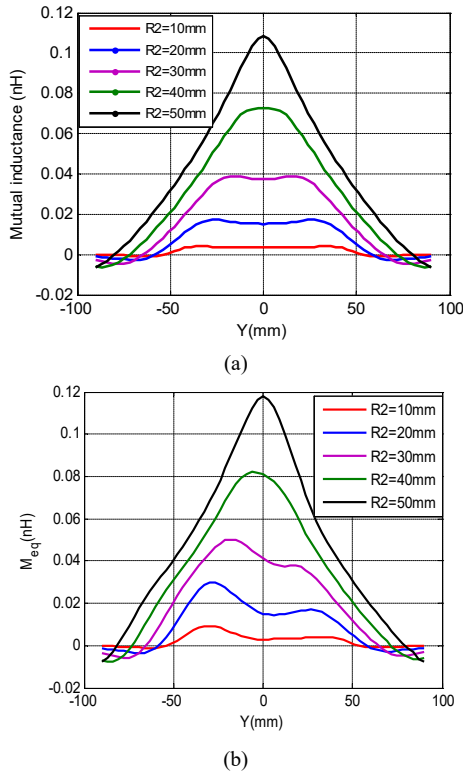

FIG. 5. Mutual inductance versus the lateral misalignment in parallel configuration, for different radii
 a. without resonator
 b. with resonator

The addition of resonator (Fig.5b) has therefore no influence on the position of the maximum of the equivalent mutual inductance (when $R_1/R_2 \sim 1$), but rather on the level of the equivalent mutual inductance. This influence is clearly seen for a radius ratio of 5 ($R_1/R_2 = 5$) between dual-coils 1-resonator and coil 2. The maximum of the magnetic coupling in this case is obtained in the center of the resonator.

The added resonator in the co-planar reader surface shift the null of mutual inductance versus lateral misalignment and increases the mutual resistance above the resonator: the mutual impedance is affected by the resonator but the levels stay weak in comparison with those obtained in the parallel configuration.

A1. Equivalent Mutual Inductance for Distance Variation

To assess the validity of this work on increasing RFID detection volume, we are also interested in the detection distance. For lateral misalignments ($Y=0\text{mm}$ and $Y=-30\text{mm}$ are respectively de center of the coil 1 and resonator, see Fig.1) and distance (d) changes between the tag and the reader, the equivalent mutual inductance of the system (M_{eq}) is evaluated according to the simulation results presented in Fig.6a.

At a distance of 10 mm, the addition of the resonator can increase the equivalent mutual inductance by 10nH (from 11nH to 21nH) above the resonator. However, the equivalent mutual inductance presents two peaks: the first one, at a position $y = -30\text{mm}$, corresponds to the alignment with the center of the resonator and the second one, $y = 30\text{mm}$, is due to the mutual inductance between coil 1 and coil 2. The mutual inductance is proportional to the sensed flow (magnetic field integration) of the reader and decreases with increasing distance d between the reader (coil 1 and resonator) and the tag (coil 2) (coherent with Biot and Savart law).

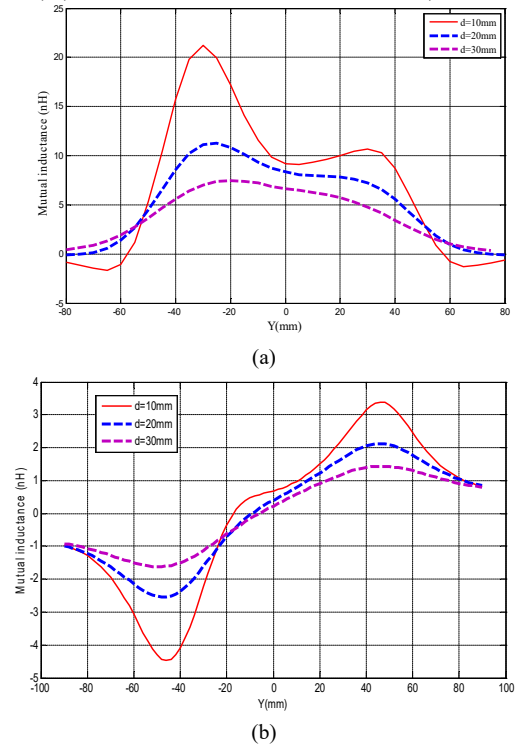

FIG. 6. Simulated equivalent mutual inductance for different values of tag distance d in parallel (a) and perpendicular (b) configuration

Similarly, in perpendicular configuration, in the case of prototype with a single coil (coil 1) wider than the tag (coil 3), the mutual inductance has two maxima at the edges of the coil 1 and a zero at its center; it is therefore symmetric, the addition of the resonator modifies this operation.

The positions of the maxima of the equivalent mutual inductance are always on the edges of the coil 1 (increased above resonator), but at the center of coil 1, the zero of M_{eq} is shifted from $y = 0\text{ mm}$ to $y = -10\text{ mm}$. This is due to the

mutual inductance between the resonator and the coil 1, which creates some additional maxima at the edges positions of the resonator.

IV. EFFECT OF THE ADDED RESONATOR ON SHOWN IMPEDANCE

In Fig.7, the input impedance in both parallel and perpendicular configuration is studied by simulation using the calculation in equations 1 and 4. The distance here is fixed at 10mm.

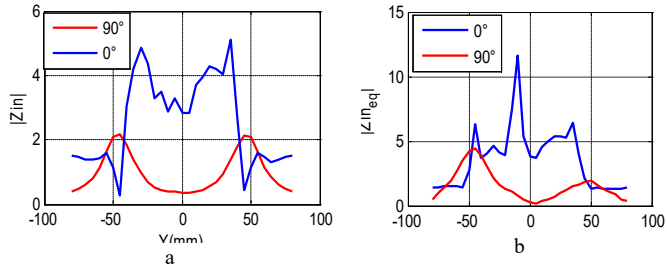

Fig.7 Input impedance (a) and equivalent input impedance (b) in parallel and perpendicular configurations

In conventional system (Fig.7a) the magnitude of the input impedance has maximum above the edges of the reader antenna: 5 Ω in parallel configuration and 2.1 Ω in perpendicular configuration, and minima at the center of the reader antenna: 3 Ω in parallel configuration and 0.5 Ω in perpendicular configuration. In this case the variation of the input impedance depends only on the mutual inductance between the reader and the tag coils. The magnitudes of the input impedance are changed with the added resonators (Fig.7b). This is due to the transformed impedances. In both parallel and perpendicular configurations, the variation of the impedances due to the mutual inductance is negligible compared to the variation due to the added resonator: the improvement of input impedance corresponds to 5 Ω in parallel configuration and 2 Ω in perpendicular configuration.

V. EXPERIMENTAL VALIDATION

An experimental test of increasing detection volume and surface with adding resonator was made using a RFID reader from Ib Technologies, which requires tuned coil antenna (1uH reference value with quality factor Q around 30).

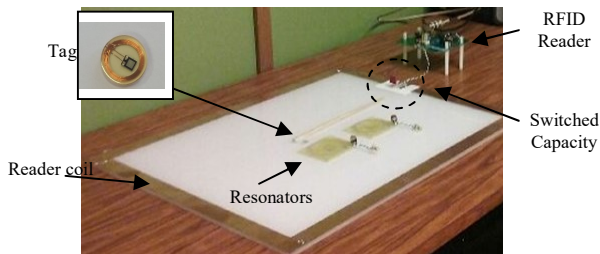

Fig.8. Experimental setup of detection

The previous simulated structure, constituted of a 1-turn coil of 370 nH inductance value, and 30cm diameter, could not be matched and associated with the Ib Technologies reader. A

new rectangular coil of 50 cm width and 35 cm height was realized with copper ribbon of 2 cm width (Fig.8) and used in measurements. The global system consists in a rectangular coil antenna reader of 1750 cm² surface, a circular coil antenna tag of 4 mm diameter and two hexagonal resonators antennas of 42 cm² surfaces.

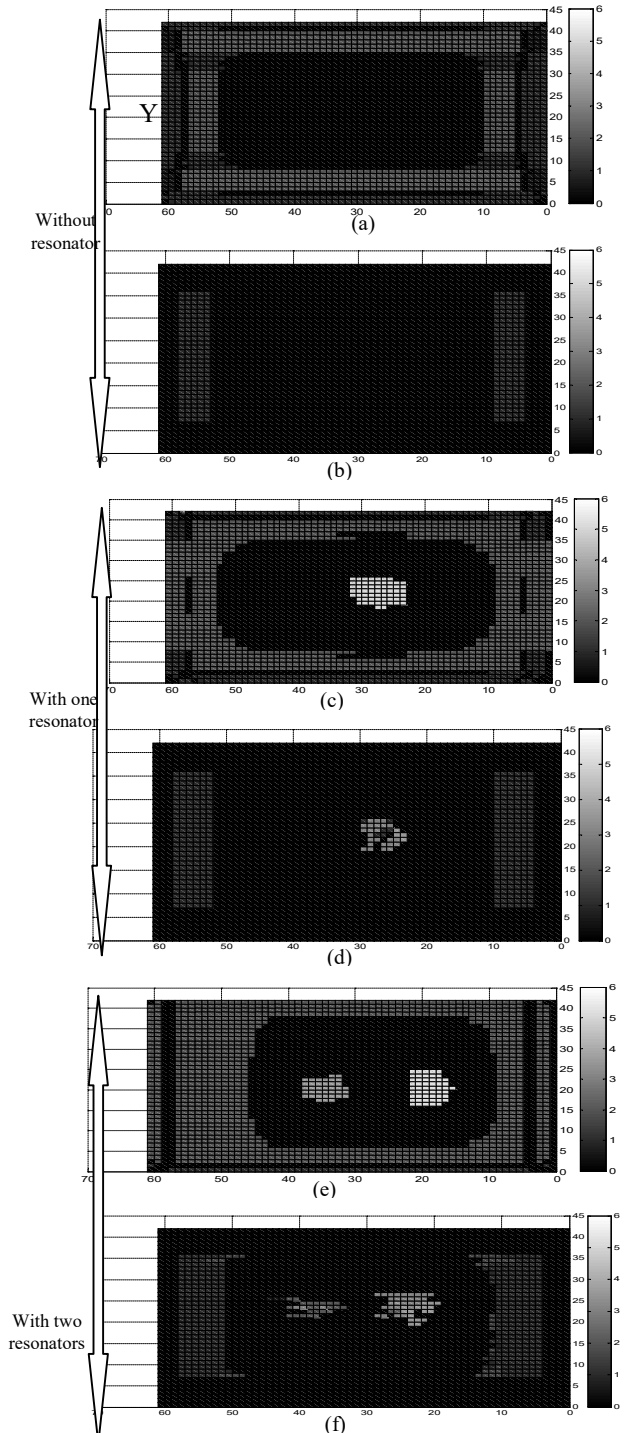

Fig.9 Surface and distance of detection in: Parallel configuration without resonator (a), with one resonator (c), with two resonators (e) and perpendicular configuration without resonator (b), with one resonator (d) with two resonators (f)

The principle of adding resonator on the co-planar surface of the reader coil was applied. The detection of parallel and perpendicular tag was evaluated for lateral misalignment and different distances between the tag and the reader antenna. When the tag is detected, a detection message appears on the computer screen (Reader software interface).

Fig.9 are the 3D plots of tag detection in parallel and perpendicular configurations without resonator (a, b), with one (c, d) and two resonators (e, f). The (X, Y) axes correspond respectively to a lateral misalignment according to the width and the length of the reader antenna (the rectangular one in Fig.8), the color scale defined the distance of detection

For resonator with size corresponding to 2.4% of the reader surface, both the volume and the surface of detection for parallel and perpendicular configuration were increased (table I). The surface of the reader was increased by (17%, 33%), and (6%, 15%) respectively for parallel and perpendicular configuration using one and two resonators, since a new detection zone appears above the resonator.

TABLE I
DISTANCE AND SURFACE OF DETECTION

Distance 'D' and surface 'S' of detection	Without resonator	With one resonator	With two resonators
Parallel configuration	D=1cm S=53%	D=5.8cm S=70%	D=5.8cm S=86%
Perpendicular configuration	D=1cm S=16%	D=3.5cm S=22%	D=3.5cm S=31%

The RFID detection results (TABLE I) exhibit clearly that new detection zones appear with the addition of the resonator in the parallel and perpendicular orientations and favor the RFID detection.

VI. CONCLUSION

In this paper, the improvement of HF RFID system performances, such as surface or/and volume of tag detection, was obtained by reader coil including resonators. The improvement of equivalent mutual inductance and input impedance was achieved thanks to the addition of a co-planar resonator, made of coil with a size in the range of those of the tag coil (with geometrical similarity).

The resonator, based on a tuned coil, was fruitful for detection in both parallel and perpendicular orientation of the tag. A dual-coils HF antenna prototype was studied. The design includes was including a resonator coil (15 mm diameter) whose surface occupies 30% of the reader surface, corresponding to a comparable tag surface (15 mm diameter).

Analytical formulas for equivalent mutual inductance and equivalent mutual resistance of the system were developed using electrical model of the structure, constituted of dual-coils reader and tag. The formulas are used in HFSS simulation to validate the operation principle.

In perspectives, the same principle will be also applied in wireless power transmission (WPT) to maximize the power transfer and the energy efficiency at the receiver and we will realize an optimized prototype with multiple resonating coils.

REFERENCES

- [1] K. Finkenzeller. RFID Handbook. third edition, Wiley.
- [2] S.I. Babic, F. Sirois, C. Akyel, "Validity check of mutual inductance formulas for circular filaments with lateral and angular misalignments". *Progress in Electromagnetics Research*, 8, pp.15-26,2009.
- [3] C. Zierhofer, E. Hochmair, "Geometric approach for coupling enhancement of magnetically coupled coils". *IEEE transactions on Biomedical Engineering*, pp.708-714,1996.
- [4] M. Grzeskowiak, A. Diet, P. S. Diao, S. Protat, C. Bourcier, Y. Le Bihan, G. Lissorgues. Pebbles Tracking Thanks to RFID LF Multi-loops Inductively Coupled Reader. *Progress In Electromagnetics Research, PIER C*, ISSN: 1937-8718, Vol. N°55, pp. 129-137, 2014.
- [5] Zhen Zhang, K. T. Chau, Chunhua Liu¹, Fuhua Li, and T. W. Ching, "Quantitative Analysis of Mutual Inductance for Optimal Wireless Power Transfer via Magnetic Resonant Coupling", *IEEE Transactions on Magnetics*, Vol.50, No.11, 2014.
- [6] A. Diet, M. Grzeskowiak, Y. Le Bihan, C. Conessa, Improving LF Reader Antenna volume of detection, for RFID token tag, with a combination of ICLs and in/out-of phase multiple-loops structures, *IEEE RFID-TA*, pp. 208-213,2014.
- [7] S. Hackl, C. Lansch¹utzer, P. Raggam, W.L. Randeu, "A Novel Method for Determining the Mutual Inductance for 13.56MHz RFID Systems", *Communication Systems, Networks and Digital Signal Processing*, pp. 297-300, 2008.