



HAL
open science

Equivalent input and output impedances in HF RFID system including resonator

Megdouda Benamara, Marjorie Grzeskowiak, Antoine Diet, Gaelle Bazin
Lissorgues, Yann Le Bihan

► **To cite this version:**

Megdouda Benamara, Marjorie Grzeskowiak, Antoine Diet, Gaelle Bazin Lissorgues, Yann Le Bihan. Equivalent input and output impedances in HF RFID system including resonator. 2017 11th European Conference on Antennas and Propagation (EUCAP), Mar 2017, Paris, France. pp.1914-1918, 10.23919/EuCAP.2017.7928863 . hal-01691613

HAL Id: hal-01691613

<https://centralesupelec.hal.science/hal-01691613>

Submitted on 11 Jul 2019

HAL is a multi-disciplinary open access archive for the deposit and dissemination of scientific research documents, whether they are published or not. The documents may come from teaching and research institutions in France or abroad, or from public or private research centers.

L'archive ouverte pluridisciplinaire **HAL**, est destinée au dépôt et à la diffusion de documents scientifiques de niveau recherche, publiés ou non, émanant des établissements d'enseignement et de recherche français ou étrangers, des laboratoires publics ou privés.



Open Archive Toulouse Archive Ouverte (OATAO)

OATAO is an open access repository that collects the work of some Toulouse researchers and makes it freely available over the web where possible.

This is an author's version published in: <https://oatao.univ-toulouse.fr/24077>

Official URL : <https://doi.org/10.23919/EuCAP.2017.7928863>

To cite this version :

Benamara, Megdouda and Grzeskowiak, Marjorie and Diet, Antoine and Lissorgues, Gaëlle and Le Bihan, Yann Equivalent input and output impedances in HF RFID system including resonator. (2017) In: 2017 11th European Conference on Antennas and Propagation (EUCAP), 19 March 2017 - 24 March 2017 (Paris, France).

Any correspondence concerning this service should be sent to the repository administrator:

tech-oatao@listes-diff.inp-toulouse.fr

Equivalent Input and Output Impedances in HF RFID System Including Resonator

Megdouda BENAMARA¹, Marjorie GRZESKOWIAK¹, Antoine DIET², Gaëlle LISSORGUES³, Yann LE BIHAN²

¹Univ Paris-Est, ESYCOM (EA 2552), UPEMLV, ESIEE-Paris, CNAM, F.77454 Marne-la-Vallée, France

²Univ. Paris Saclay, GeePs (UMR8507), CNRS, CentraleSupélec, Univ. Paris Sud, UPMC) 91192 Gif-sur-Yvette, France

³ESIEE-Paris, ESYCOM (EA 2552), UPEMLV, ESIEE-Paris, CNAM, Cite Descartes, BP99, 93162 Noisy le Grand

Abstract— High Frequency Radio Frequency Identification (HF RFID) system based on Magnetically Coupled Reader Resonator Coils (MCRRC) is reported. The proposed system consists of reader antenna including small resonant coil operating by magnetic coupling with the tag coil. In the proposed system, the reader and tag impedances are modified. The equivalent electrical model is used to express the equivalent impedance matrix and used to express the equivalent input and output impedances of the system. The formulas are confirmed by comparison between High Frequency Structure Simulator (HFSS) results and measures.

Index Terms—antenna, impedance matrix, RFID, magnetic coupling.

I. INTRODUCTION

RFID (Radio Frequency Identification) HF (High Frequency, 13.56 MHz) is based on inductive coupling effect between the reader and the tag coils. According to the distance and the positioning (planar and angular) between the two coils, the impedance of the tag chip is modified, the shift of the impedance is interpreted by the reader antenna, this is the principle of the load modulation [1].

In several applications like as tracking, the tag is misaligned and has small size coil compared to the reader coil. In this case, the reader antenna has to be changed in multi-loop reader antenna to ensure detection [2][3][4]. In this study the proposed concept is to changed reader antenna on magnetically coupled reader resonator coils (MCRRC), the link between the reader including resonator and the tag depends on the equivalent mutual impedance [5][6][7][8]. Preliminary results of the proposed design confirm its interest in improving both surface (in the case of lateral misalignment of the tag above the reader antenna surface) and distance of detection [4][5]. The difficulty is the need of adjusting the impedance of the matching circuit of the reader antenna according to the electrical properties of the resonator in order to maintain the resonance frequency at 13.56MHz [5].

The proposed structure seen in Fig.1 represents the interaction between the two reader coils (coil 1 and resonator) and the coil of the tag (2). Resonator coil has a radius R_{res} of 15 mm. Coils 1 and 2 present respectively a radius of 50 mm and 15 mm. In [5] the calculation of the equivalent impedance parameters is given, the work concerns the improvement of the equivalent mutual impedance (as link between the reader multi-coil and the tag coil) at 13.56MHz.

In this paper, all the equivalent impedance parameters of the system are studied according to the lateral misalignment of the tag above the reader antenna in the case of conventional and MCRRC RFID system with MCRRC. The calculated equivalent parameters are confirmed by comparison between HFSS simulations, calculations and measurements in section 2. In section 3, the influence of the added resonator on the equivalent input and output impedances of the system is investigated. New formulas defining the equivalent input and output impedances are given and confirmed by simulation.

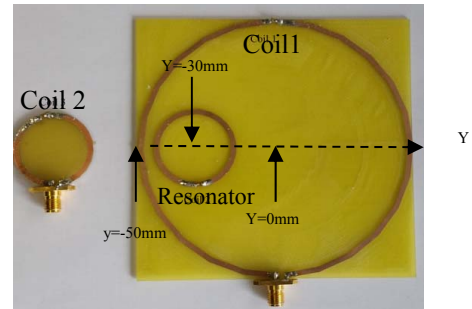

Fig.1. Fabricated tag coil 2 (left) and MCRRC (right)

II. EQUIVALENT CIRCUIT FOR RFID SYSTEM

Fig.2 shows the equivalent circuit of conventional and complex (MCRRC) RFID system where: $L_1= 0.3 \mu\text{H}$, $L_2= 0.058 \mu\text{H}$ and $L_{res}= 0.058 \mu\text{H}$ are respectively the self-inductances of coils 1, 2 and the resonator. $r_1= 0.2\Omega$, $r_2= 0.1 \Omega$ and $r_{res}= 0.1 \Omega$ are their internal resistances. $C_1=0.45 \text{ nF}$, $C_2=2.32 \text{ nF}$ and $C_{res}=2.32 \text{ nF}$ are the series tuning capacitors at 13.56 MHz.

A. Equivalent impedance matrix calculation

The voltages V_1 , V_{res} and V_3 in the circuit (b) satisfy the following relations (1), with $M_{ij}=M_{ji}$ being the mutual inductances between coils 1, 2, 3, ($1 < i, j < 3$)

$$\begin{pmatrix} V_1 \\ V_{res} \\ V_2 \end{pmatrix} = \begin{bmatrix} Z_{11} & Z_{1res} & Z_{13} \\ Z_{res1} & Z_{resres} & Z_{res3} \\ Z_{21} & Z_{2res} & Z_{22} \end{bmatrix} \begin{pmatrix} I_1 \\ I_{res} \\ I_2 \end{pmatrix} \quad (1)$$

$$= \begin{bmatrix} r_1 + j\omega L_1 & j\omega M & j\omega M_{12} \\ j\omega M_{res1} & r_{res} + j\omega L_{res} & j\omega M_{res2} \\ j\omega M_{21} & j\omega M_{2res} & r_2 + j\omega L_2 \end{bmatrix} \begin{pmatrix} I_1 \\ I_{res} \\ I_2 \end{pmatrix}$$

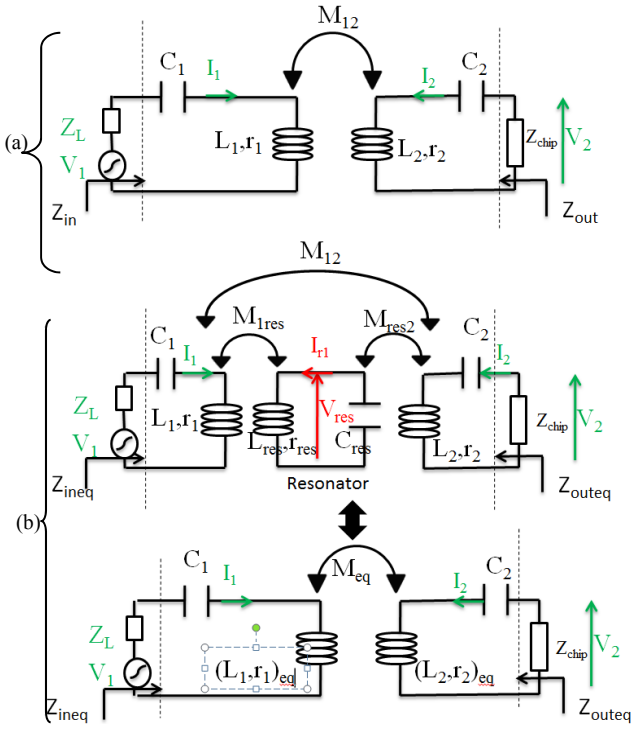

Fig.2. Electrical model for conventional (a) and MCCRC (b) RFID system

The equivalent impedance matrix (Z_{10} matrix) of the MCCRC system (b) is given by (the complete calculation of the equivalent matrix is developed in [5]):

$$Z_{ii} = r_1 - \frac{\omega^2 M_{res}^2}{\alpha} + j\omega L_1 + Z_{C1} \quad (2)$$

$$Z_{io} = j\omega M_{12} - \frac{\omega^2 M_{1res} M_{res} M_{res} 2}{\alpha}$$

$$Z_{oi} = j\omega M_{21} - \frac{\omega^2 M_{2res} M_{res} M_{1res}}{\alpha}$$

$$Z_{oo} = r_2 - \frac{\omega^2 M_{res}^2}{\alpha} + j\omega L_2 + Z_{C2}$$

With
$$\alpha = \frac{j}{\omega C_{res}} - (j\omega L_{res} + r_{res})$$

The parameters of the Z_{10} matrix can be expressed as:

$$Z_{11eq} = j\omega \left(L_1 - \frac{1}{C_1 \omega^2} + \omega(M_{1res})^2 \gamma \right) + \omega^2 (M_{1res})^2 \delta + r_1 \quad (3)$$

$$Z_{12eq} = j\omega (M + \omega M_{1res} M_{res} 2 \gamma) + \omega^2 M_{1r} M_{r2} \delta$$

$$Z_{21eq} = j\omega (M + \omega M_{res} 2 M_{res} 1 \gamma) + \omega^2 M_{2res} M_{res} 1 \delta$$

$$Z_{22eq} = j\omega \left(L_2 - \frac{1}{C_2 \omega^2} + \omega(M_{2res})^2 \gamma \right) + \omega^2 (M_{2res})^2 \delta + r_2$$

With

$$\gamma = \frac{1}{\omega C_{res}} - \omega L_{res}, \quad \delta = \frac{r_{res}}{\left(\frac{1}{\omega C_{res}} - \omega L_{res} \right)^2 + r_{res}^2}$$

In MCCRC system, the resonator influence is depicted in both reader and tag impedances by the M_{1res} and M_{2res} parameters but also by impedance coupling (in this case, the mutual impedance has a real and an imaginary part).

B. Validation of the calculated equivalent impedance matrix

The equivalent impedance matrix parameters are analyzed in this part according to the tag misalignment in both cases with and without resonator. These parameters are studied in this part by calculation, HFSS simulations (using the analytical model in equation) and confirmed by measurements. The distance between the reader and the tag coils is chosen to 10mm: at this distance, the impact of the resonator is seen clearly on the mutual impedance in [5].

The simulated results concern structure where the coils are designed with perfect conductor to reduce the computation time under HFSS, while in measure, the results are presented for realized coils with cooper. The different materials used respectively in simulation (without substrate) and measure (with FR4 substrate) generate different electrical properties (consequently different resonance frequencies). The aim of this part is to confirm the developed electrical model by comparison of the evolution of the equivalent impedance parameters around the resonance frequency.

B.1. Impedance of the reader (Z_{11} and Z_{11eq})

For three positions of the misaligned tag: $y=-50$ mm, $y=-30$ mm and $y=0$ mm in Fig.1 corresponding respectively to the positions where the tag is above the edges of the reader antenna, the center of the resonator and the center of the reader antenna, we reported in fig.3 the evolution of the imaginary and the real parts self-impedance of the reader in the two cases without (Z_{11}) and with resonator (Z_{11eq}).

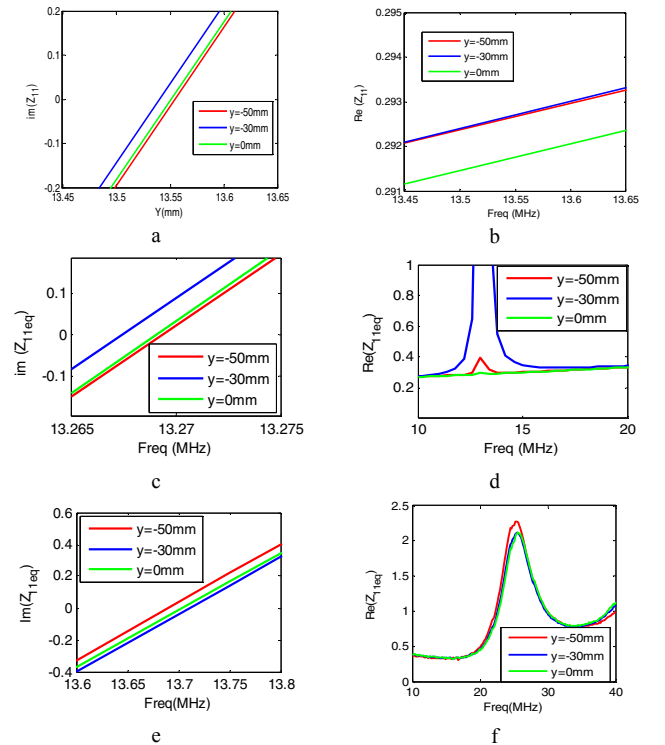

Fig.3. Imaginary and real part of simulated Z_{11} (a, b), simulated Z_{11eq} (c, d) and measured Z_{11eq} (e, f) parameters

In the case without resonator (Fig.3 a, b), the resonance frequency is shifted according to the position of the tag, but the frequency shift, in this case, can be negligible, the resonance frequency is around 13.55MHz. The added resonator shifted the frequency; the resonance frequency of the Z_{11eq} impedance is around 13.27 MHz for the different lateral positions of the tag. The amplitude of the real part is modified according to the tag misalignment. Its maximum in the case without resonator is around 0.29 Ω . This maximum is improved with the added resonator: at $y=0$ mm the variation of the real part is negligible compared to the case of $y=-50$ mm and $y=-30$ mm where the real part of the Z_{11eq} impedance is strongly influenced by the added resonator. Also, the results are confirmed by measurements. In measured results the frequency shift according to the tag misalignment for the structure with resonator is confirmed.

B.2. Impedance of the reader (Z_{22} and Z_{22eq})

In the same way, fig.4 reports, the variation of the real and the imaginary part of the self-impedance of the tag in conventional (Z_{22}) and MCRR system (Z_{22eq}).

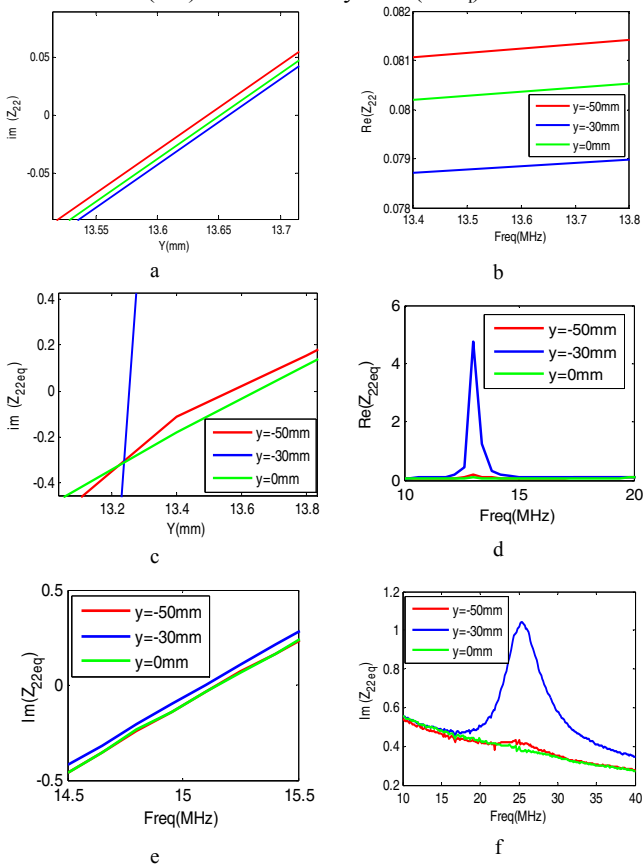

Fig.4. Imaginary and real part of simulated Z_{22} (a, b), simulated Z_{22eq} (c, d) and measured Z_{22eq} (e, f) parameters

In conventional system (without resonator), the resonance frequency of the tag is seen around 13.6MHz, according to the tag positioning, both resonance frequency (null of the imaginary part) and the amplitude of the real part are changed. This variation, is negligible compared to the

variation in the case of MCRR system, the maximum variation of the real and the imaginary parts of the tag impedance is seen for $y=-30$ mm (when the tag is above the resonator). The results of the calculated equations are conformed by measurements, where the resonance frequency of the measured tag is around 15MHz.

B.3. Impedance of the reader (Z_{12} and Z_{12eq})

In this part, we are also interesting on the mutual impedance parameter. In conventional system, the imaginary part is used to calculate the mutual inductance between the reader and the tag coils, while the real part is very low and close to zero. A few variations of these parameters are seen according to the tag misalignments. While in MRCC system, both real and imaginary parts of the Z_{12} impedance are changed, in simulation, the maximum of this variation is seen around 13 MHz for $y=-30$ mm. in measurements, the variation has maximum values at 25 MHz. These correspond to the resonance frequencies of the reader and the tag coils in MCRR system.

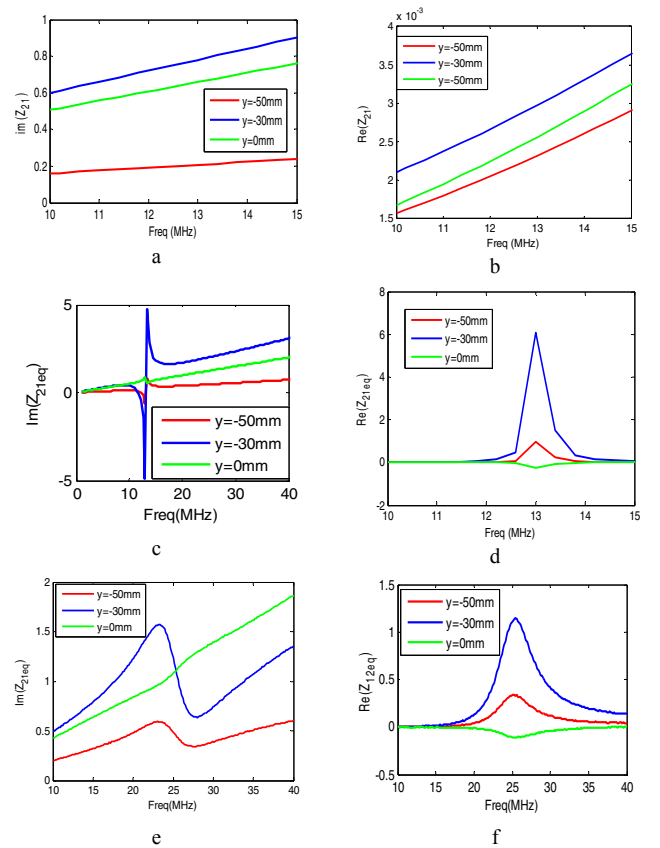

Fig.5. imaginary and real part of simulated Z_{12} (a, b), simulated Z_{12eq} (c, d) and measured Z_{11eq} (e, f) parameters

In this part, we confirm that:

- The added resonator modifies all the parameters of the impedance matrix.
- The developed calculation in equation (3) is validated by comparison between simulations and measures.

-The interest of the added resonator is depicted on the improvement of the mutual impedance of the system.

-Both the equivalent self-impedances of the reader and the tag coils are modified; consequently a frequency shift is generated

-According to the lateral positioning of the tag, the variation of the impedance parameters is more important when the tag is above the resonator ($y=-30$ mm).

III. EFFECT ON INPUT AND OUTPUT IMPEDANCES

The MCRRC system is benefic for improving generated magnetic field by the reader coil, but the main constraint of such system is the influence on the impedance parameters. In this part, the input and output impedances are studied by calculation and simulation. The input and the output impedances are defined using the equivalent impedance matrix parameters in equation (3).

A. Calculation of equivalent input and output impedances

In conventional structure (a), the input and output impedances of the system, respectively the impedance of the reader and of the tag, are depending on the self-impedances of the reader and the tag and the mutual inductance between them:

$$\begin{aligned} Z_{in} &= Z_{11} - \frac{Z_{12}^2}{Z_{22} + Z_{chip}} \\ &= r_1 + j\omega L_1 + \frac{\omega^2 M^2}{r_2 + j\omega L_2 + Z_{chip}} \quad (4) \\ Z_{out} &= Z_{22} - \frac{Z_{21}^2}{Z_{11} + Z_L} \\ &= r_2 + j\omega L_2 + \frac{\omega^2 M^2}{r_1 + j\omega L_1 + r_L} \end{aligned}$$

Using the equation (4), we define the equivalent input and output impedances by replacing the impedance parameters by the equivalent impedance parameters.

The equivalent input impedance can be express by:

$$\begin{aligned} Z_{in_{eq}} &= Z_{11_{eq}} - \frac{Z_{12_{eq}}^2}{Z_{22_{eq}} + Z_{chip}} \quad (5) \\ &= \text{Im}(Z_{in_{eq}}) + re(Z_{in_{eq}}) \end{aligned}$$

With:

$$\begin{aligned} \text{Im}(Z_{in_{eq}}) &= \text{Im}(Z_{11_{eq}}) \\ &- \left[\frac{\left(\left(\text{Im}(Z_{12_{eq}}) \right)^2 - \left(re(Z_{12_{eq}}) \right)^2 \right) \left(\text{Im}(Z_{22_{eq}} + Z_{chip}) \right)^2}{\left(\text{Im}(Z_{22_{eq}} + Z_{chip}) \right)^2 + \left(\text{Re}(Z_{22_{eq}} + Z_{chip}) \right)^2} \right] \\ &+ \left[\frac{2 \left(\text{Im}(Z_{12_{eq}}) \right) \left(\text{Re}(Z_{12_{eq}}) \right) \left(\text{Re}(Z_{22_{eq}} + Z_{chip}) \right)}{\left(\text{Im}(Z_{22_{eq}} + Z_{chip}) \right)^2 + \left(\text{Re}(Z_{22_{eq}} + Z_{chip}) \right)^2} \right] \end{aligned}$$

$$\begin{aligned} \text{Re}(Z_{in_{eq}}) &= \text{Re}(Z_{11_{eq}}) \\ &- \left[\frac{\left(\left(\text{Re}(Z_{12_{eq}}) \right)^2 - \left(re(Z_{12_{eq}}) \right)^2 \right) \left(\text{Re}(Z_{22_{eq}} + Z_{chip}) \right)^2}{\left(\text{Im}(Z_{22_{eq}} + Z_{chip}) \right)^2 + \left(\text{Re}(Z_{22_{eq}} + Z_{chip}) \right)^2} \right] \\ &+ \left[\frac{2 \left(\text{Im}(Z_{12_{eq}}) \right) \left(\text{Re}(Z_{12_{eq}}) \right) \left(-\text{Im}(Z_{22_{eq}} + Z_{chip}) \right)}{\left(\text{Im}(Z_{22_{eq}} + Z_{chip}) \right)^2 + \left(\text{Re}(Z_{22_{eq}} + Z_{chip}) \right)^2} \right] \end{aligned}$$

Also, the equivalent output impedance is expressed by

$$\begin{aligned} Z_{out_{eq}} &= Z_{22_{eq}} - \frac{Z_{12_{eq}}^2}{Z_{11_{eq}} + r_L} \quad (6) \\ &= \text{Im}(Z_{out_{eq}}) + re(Z_{out_{eq}}) \end{aligned}$$

With:

$$\begin{aligned} \text{Im}(Z_{out_{eq}}) &= \text{Im}(Z_{22_{eq}}) \\ &- \left[\frac{\left(\left(\text{Im}(Z_{12_{eq}}) \right)^2 - \left(re(Z_{12_{eq}}) \right)^2 \right) \left(\text{Im}(Z_{11_{eq}} + Z_L) \right)^2}{\left(\text{Im}(Z_{11_{eq}} + Z_L) \right)^2 + \left(\text{Re}(Z_{11_{eq}} + Z_L) \right)^2} \right] \\ &+ \left[\frac{2 \left(\text{Im}(Z_{12_{eq}}) \right) \left(\text{Re}(Z_{12_{eq}}) \right) \left(\text{Re}(Z_{11_{eq}} + Z_L) \right)}{\left(\text{Im}(Z_{11_{eq}} + Z_L) \right)^2 + \left(\text{Re}(Z_{11_{eq}} + Z_L) \right)^2} \right] \end{aligned}$$

$$\begin{aligned} \text{Re}(Z_{out_{eq}}) &= \text{Re}(Z_{22_{eq}}) \\ &- \left[\frac{\left(\left(\text{Re}(Z_{12_{eq}}) \right)^2 - \left(re(Z_{12_{eq}}) \right)^2 \right) \left(\text{Re}(Z_{11_{eq}} + Z_L) \right)^2}{\left(\text{Im}(Z_{11_{eq}} + Z_L) \right)^2 + \left(\text{Re}(Z_{11_{eq}} + Z_L) \right)^2} \right] \\ &+ \left[\frac{2 \left(\text{Im}(Z_{12_{eq}}) \right) \left(\text{Re}(Z_{12_{eq}}) \right) \left(-\text{Im}(Z_{11_{eq}} + Z_L) \right)}{\left(\text{Im}(Z_{11_{eq}} + Z_L) \right)^2 + \left(\text{Re}(Z_{11_{eq}} + Z_L) \right)^2} \right] \end{aligned}$$

From the calculation, both input and output impedances are modified by the added resonator.

B. Simulation results

The equivalent input and output impedances are studied in this part by HFSS simulations versus the lateral misalignment at resonance frequency of 13.56MHz (using the analytical model in equations 4, 5 and 6) (Fig.6). In this part, the distance between the reader and the tag coils is 10 mm. The study is done for lateral misalignment of the tag coil above the reader coil ($-50 \text{ mm} < Y < 50 \text{ mm}$).

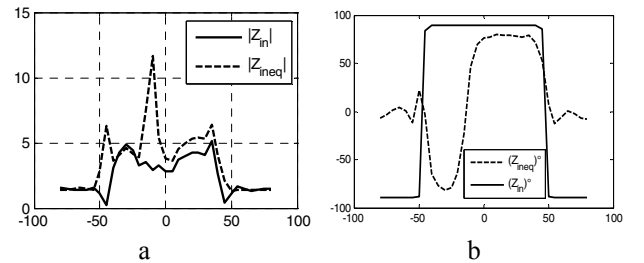

REFERENCES

- [1] K. Finkenzeller. RFID Handbook. third edition, Wiley.
- [2] M. Grzeskowiak, A. Diet, P. S. Diao, S. Protat, C. Bourcier, Y. Le Bihan, G. Lissorgues. Pebbles Tracking Thanks to RFID LF Multi-loops Inductively Coupled Reader. Progress In Electromagnetics Research, PIER C, ISSN: 1937-8718, Vol. N°55, pp. 129-137, 2014.
- [3] C. Zierhofer, E. Hochmair, "Geometric approach for coupling enhancement of magnetically coupled coils". *IEEE transactions on Biomedical Engineering*, pp.708-714,1996.
- [4] A. Diet, M. Grzeskowiak, Y. Le Bihan, M. Biancheri-Astier, M. Lahrar, C. Conessa, M. Benamara, G. Lissorgues, F. Alves, Improvement of RFID HF tags detection with a distributed diameter coil, *Antennas and Wireless Propagation Letters*, in press
- [5] M. Benamara, M. Grzeskowiak, A. Diet, Y. Le Bihan, G. Lissorgues, Calculation of the Equivalent Mutual Impedance in Complex HF RFID Systems, *Iccom 2016, Dubrovnik*, in press
- [6] C. Liu, Y. Dong. Resonant coupling of a passive inductance-capacitance-resistor loop in coil-based sensing system. *IEEE sensors journal*, Vol, 12, NO. 12, pp.3417-3423,2012
- [7] E. WAFFENSCHMIDT. Homogeneous Magnetic Coupling for free positioning in inductive wireless power system. *IEEE journal of emerging and selected topics in power electronics*, Vol. 3, NO. 1, pp.226-233,2015
- [8] Zhen Zhang, K. T. Chau, Chunhua Liu1, Fuhua Li, and T. W. Ching, "Quantitative Analysis of Mutual Inductance for Optimal Wireless Power Transfer via Magnetic Resonant Coupling", *IEEE Transactions on Magnetics*, Vol.50, No.11, 2014.

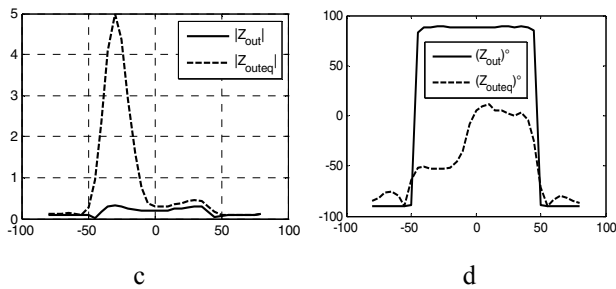

Fig.6. modules of input and equivalent input impedances (a), modules of input and equivalent input impedances (a), phases of input and equivalent input impedances (b), modules of output and equivalent output impedances (b), phases of output and equivalent output impedances (b)

The magnitudes of the input and output impedances are changed with the added resonators. This is due to the transformed impedances in equation (5 and 6). In both reader and tag coils, the variation of the impedances due to the mutual inductance is negligible compared to the variation due to the added resonator: the improvement of the reader and the tag impedances corresponds respectively to 5Ω and 3Ω .

In conventional reader antenna, the phase shift is depending on the tag positioning: the mutual inductance between the reader and the tag coils is the only cause of the phase shift. While, in MCR structure, the evolution of the phase is depending on the mutual coupling between the reader and the tag coil (M in equation 4) but also on the electrical properties of the resonator (γ) and the added equivalent mutual inductances (M_{1res} and M_{2res}). The phase shifts in this case are higher than conventional structure. This means, a frequency shift due to the transformed impedances.

IV. CONCLUSION

In this paper, the improvement of mutual impedance, in HF RFID system, is achieved thanks to the addition of a coplanar resonator, made of coil with a size in the range of those of the tag coil (with geometrical similarity).

Analytical formulas for equivalent impedance parameters of the system are developed using electrical model of the structure, constituted of dual-coils reader and tag. The calculation is confirmed by comparison between HFSS simulations and VNA measurements. These parameters are used to express the equivalent input and output impedances of the system.

The added resonator is benefic to improving mutual coupling between the reader and the tag coils, but it creates a phase shift on both equivalent input and output impedance. The use of such system demands the modification of the matching circuit of the reader and the tag according to the electrical properties of the resonator and its positioning inside the reader antenna surface.

The work in progress relates to automatic matching circuit based on equations (5 and 6). The shift frequency in complex HF RFID will be studied and rectified using automatic switched capacitances.