

# Contribution to Partial Discharge Analysis in Inverter-fed Motor Windings for Automotive Application

Loucif BENMAMAS<sup>1,2</sup>, Philippe TESTE<sup>1</sup>,  
Guillaume KREBS<sup>1</sup>, Emmanuel ODIC<sup>1</sup>

<sup>1</sup> GeePs | Group of electrical engineering - Paris,  
UMR CNRS 8507 CentraleSupélec, Univ. Paris-Sud,  
Université Paris-Saclay,  
Sorbonne Universités, UPMC Univ Paris 06  
3 & 11 rue Joliot-Curie, Plateau de Moulon 91192 Gif-  
sur-Yvette CEDEX, France  
loucif.benmamas@vedecom.fr

Franck VANGRAEFSCHPE<sup>2</sup> and Tahar HAMITI<sup>2</sup>

<sup>2</sup> Institut VEDECOM | Véhicule Décarboné Communicant  
et sa Mobilité  
77 rue des chantiers, 78000 Versailles, France  
tahar.hamiti@vedecom.fr

**Abstract**—The work presented here is part of a larger study concerning the analysis of electrical stress and degradation phenomena of electrical insulation of low voltage machines fed by Pulse Width Modulation (PWM) controlled inverter. The goal is to assess the risk of partial discharge (PD) in stator windings of rotating machines. In this objective, two complementary approaches are adopted: electrostatic simulations using Finite Element Method (FEM) in 2D approximation, and experimental measurements. The model seems to be a good tool allowing an approximation of PD occurrence in a given wire type. In the experimental part of this study, a simple and efficient method to detecting PD under PWM controlled voltage is presented.

**Keywords**—*Electric vehicles; Modeling; Partial Discharge; Windings.*

## I. INTRODUCTION

This study is part of a research program dedicated to the electrification of future vehicles. This electrification is accompanied by an increase of on-board electric powers and probably of voltage amplitudes used. In low and medium voltage electric rotating machines used in transport applications, the use of adjustable speed drives (ASD) is common. These converters are usually composed of IGBTs (Insulated Bipolar Gate Transistors) operating at high switching frequencies and having very short voltage rise times. As a result, the stator winding is subjected to steep-fronted voltage which distribution over the turns depends especially on the parasitic capacitances between the turns or between the turns and the stator frame. The distribution of these over-voltages along the winding is nonlinear [1] and so may lead to significant turn to turn voltages.

In the first stage of our study, we developed a model able to reproduce the behavior of a coil in a wide frequency range and allows a description of electrical phenomena on the scale of a turn, in order to reproduce at best the behavior of a coil subjected to a PWM type excitation [2]. In this paper we present the second part of the study. The goal is to assess the risk of

partial discharge (PD) in stator windings of rotating machines. For this, two complementary methods are used: electrostatic simulations using finite element method (FEM) in 2D approximation, and experimental measurements.

In the first part of the paper, a model based on 2D finite element computation is presented. It consists in modeling two parallel wires taking into account real dimensions of experimental samples. The electrostatic simulation results are compared to Paschen law in order to evaluate the breakdown voltage.

The second part deals with experimental measurements of Partial Discharge Inception Voltage (PDIV) on two parallel magnet wires. The aim is to validate the results obtained using electrostatic simulations. A comparison between AC voltage source and PWM like power supply was also investigated, a method to achieve PD detection based on filtering the surrounding and PWM switching noise is presented and discussed.

## II. MODELING

### A. Evaluation criterion

The obtained theoretical curve is compared to Paschen's curve obtained experimentally for air at 20°C [3]. Paschen law is an empiric representation of the breakdown voltage  $V_B$  between two electrodes as a function of the product  $p*d$  where  $p$  is the pressure of the gas and  $d$  the distance between the electrodes. Paschen law is established using two metallic electrodes having plane geometry, in a way to get a homogenous field distribution between the electrodes [4]. This curve is obtained from the expressions below:

$$V_B = \frac{Bpd}{c + \log(pd)} \quad (1)$$

$$C = \log\left(\frac{A}{\log\left(1+\frac{1}{\gamma}\right)}\right) \quad (2)$$

where A and B are experimental parameters describing the first ionization mechanism and  $\gamma$  the secondary emission coefficient of Townsend which is defined as the ratio between the number of secondary electrons and an incident ion, it depends mainly on the nature of electrodes. In this study we do not consider low pressure conditions.

### B. Simulation method

The performed simulations consist in calculating the potential difference between two insulated magnet wires, by taking into account the voltage drop between the inner copper and the outer insulation thickness, the theoretical results are compared to Paschen law. To do this, we suppose that along a straight line  $d_i$ , as illustrated in fig. 1, the electric field is uniform. In reality, the field lines are slightly curved but at low distances this assumption is plausible as the difference found is less than 1% (fig. 1) while it is about 7% for  $d \geq 50\mu\text{m}$ .

Considering this assumption, from  $y = 0$  corresponding to the minimum distance between the turns to the maximum distance  $y = R_{ext}$  ( $R_{ext}$  being the outer radius of the turn), we can plot a curve  $V(d)$  with  $d$  varying from  $1\mu\text{m}$  to  $2 * R_{ext}$  (fig. 2).

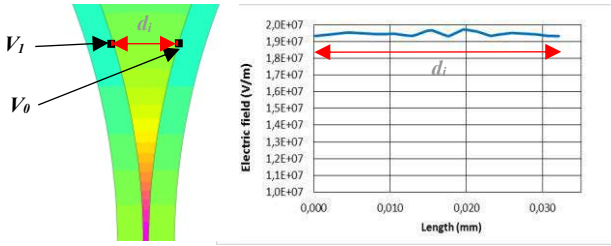

Fig. 1. Field distribution along a segment between two turns

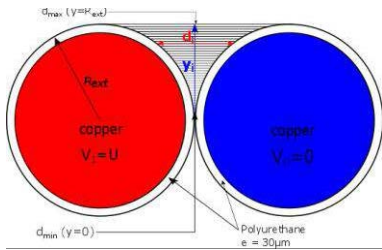

Fig. 2. 2D electrostatic calculation of voltage stress between two turns

### C. Simulation results

Applying the method described above, several simulations have been conducted. For different values of voltage (U) applied on the copper periphery, voltages in the air gap are calculated as a function of the distance between the insulation extremities, and compared to the experimental Paschen's curve.

It is quite difficult to know the dielectric constant of enamel materials because mostly they are constituted of several layers having different properties. Adding to this, it depends on temperature and frequency [5]. Yet it is an important parameter

in the voltage stress, the polyurethane have a relative permittivity either in the range of [2,9-4,3], or [6,7-7,5] depending if it is charged or not respectively [6]. Fig. 3 shows that when applying a voltage of  $U = 830V$ , for small inter-turn distances ( $< 100\mu\text{m}$ ), the higher the relative permittivity the higher is the voltage stress in the air gap because the dimensions of the air gap are close to that of the insulation thickness. We can also see that the curve for  $\epsilon_r = 3,5$  makes first contact with Paschen's curve for this applied voltage, the PDIV can be defined yet at this voltage of  $830V_{max}$ , the distance at which the curve reaches Paschen's condition is situated between  $10\mu\text{m}$  and  $50\mu\text{m}$ .

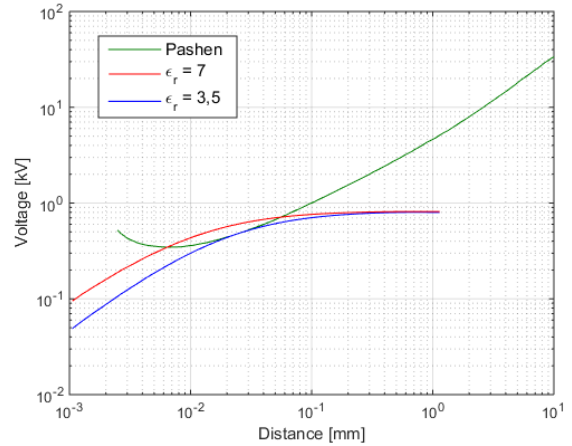

Fig. 3. Influence of relative permittivity on PDV

The impregnation impact was also investigated. In an impregnated coil, the critical zones where the PDs appear are supposed to be filled with varnish, but the impregnation techniques do not guarantee the absence of air-voids because it is not possible to perfectly control the varnish penetration. Fig. 4 shows that depending on the position ( $y_i$ ) and size of the void, in some cases the electric field within the void is as important as in the case of non-impregnated coil configuration. Thus, in the experimental part of this work, we only consider the case without impregnation, i.e. the worst case in term of PD activity.

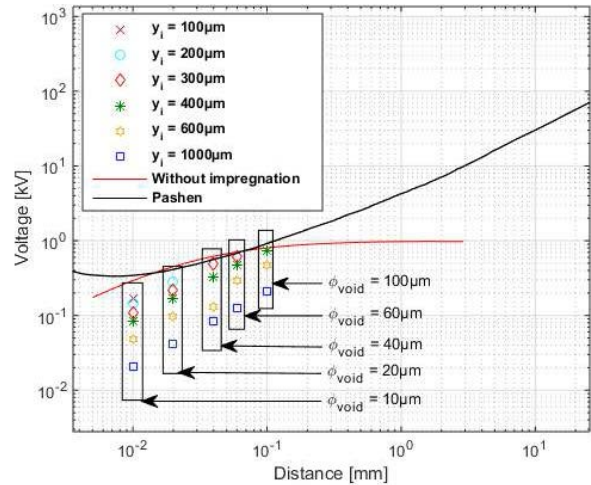

Fig. 4. Impact of voids distribution within an impregnation on PDIV

### III. EXPERIMENTAL SET-UP

#### A. Samples

In order to validate the results obtained using electrostatic simulations, a geometry allowing the study of 2 parallel magnet wires has been constructed, as shown in fig. 5. The device allows maintaining the two wires almost parallel along 15cm length. The wires are tied together at the middle in order to ensure a good contact between them without altering the electric field distribution between the turns.



Fig. 5. Two parallel magnet wires sample

#### B. Measurement methods

1) *AC power supply* : an AC 50Hz (15kV RMS) power supply is used. A protective resistor of  $R = 20M\Omega$  is connected in series with the generator to protect the studied device from high current. PD detection is achieved using a current transformer CT1 (1GHz Bandpass).

2) *PWM Like power supply* : the experimental bench used in this part is presented in Fig. 6, it is constituted of a 3kV-10mA DC power supply, a 1700V half bridge IGBT power module, a high voltage differential probe and an oscilloscope.

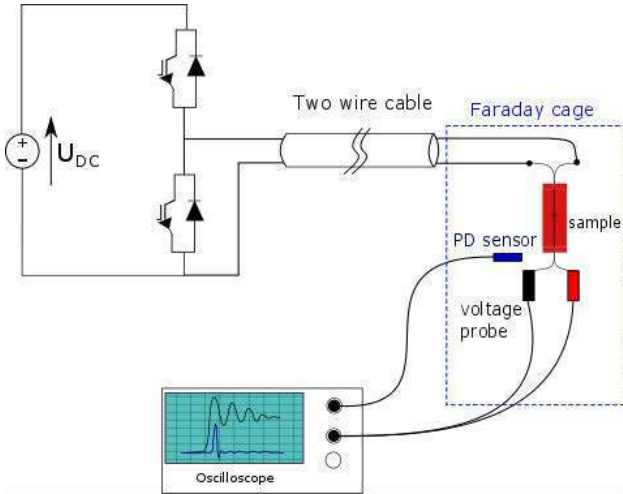

Fig. 6. Experimental set-up

The control is performed using a low frequency generator. The voltage characteristics of the bridge output are as follows:

- Switching frequency:  $f = 1 \text{ kHz}$
- Unipolar positive voltage waveform
- Duty cycle :  $\alpha = 20\%$
- Voltage rise time (10% to 90% of  $V_{dc}$ ) :  $t_r = 80 \text{ ns}$

A 2m two wire cable is used in order to amplify the overvoltage at the sample input up to 150% of the converter input voltage, Fig. 7 shows an example of the voltage waveform at the sample input where the DC voltage is  $V_{dc} = 1160 \text{ V}$ .

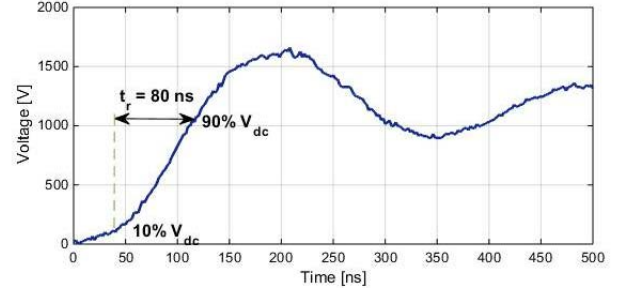

Fig. 7. Voltage waveform under PWM

In terms of PD detection, when using AC 50Hz power supply, the detection is quite simple using current probes because no high frequency disturbance exist. But using PWM the detection is perturbed by the switching of IGBTs that have high frequency components interfering with the PD signals. Non-intrusive methods using antenna sensors are more suitable, here a coaxial cable stripped to expose its core along 1cm length is used [7]. This sensor, shown in fig.8, is an efficient way to detect PD, but mostly it must be completed with high pass filters in the experimental measurements in order to increase the signal-to-noise ratio [8]. In this study we opted for a simple method to do the filtering using the trigger features of the oscilloscope. Indeed, separation between noise and PD signals can be achieved by programming the trigger on transient events having a rise time lower than 1ns. In addition, the sample is housed in a Faraday cage allowing to highly attenuate the surrounding noise.



Fig. 8. Coaxial cable sensor

#### C. Results an Discussion

First of all, in order to verify the effectiveness of the DP detection method using the antenna sensor, a comparison between recorded signals with and without PD is performed. Fig. 9 shows the recorded signals from the antenna with and without PD, in both situation, the IGBT switching signal was detected, and clearly distinguished from the PD signal (red curve) at the peak voltage. Fig. 10 shows the Fourier transform of both signals, it can be observed that the frequency components of the surrounding noise, in the order of tens of MHz, is lower than the PD ones which is rather in the GHZ range.

One of the aim of the experiments carried out here is to measure the PDIV in both configurations (AC 50Hz and PWM supplies). For this purpose, the experimental protocol

considered consists in increasing the voltage in steps of 50V every 30s, leaving sufficient time for the establishment of a discharge if the PDIV is reached. For each configuration ten measurements were done. Table 1 shows the mean values of measured PDIVs and the standard deviation of the measurements. PDIV value measured under AC voltage is very close to the theoretical one calculated with a relative permittivity of  $\epsilon_r = 3,5$ .

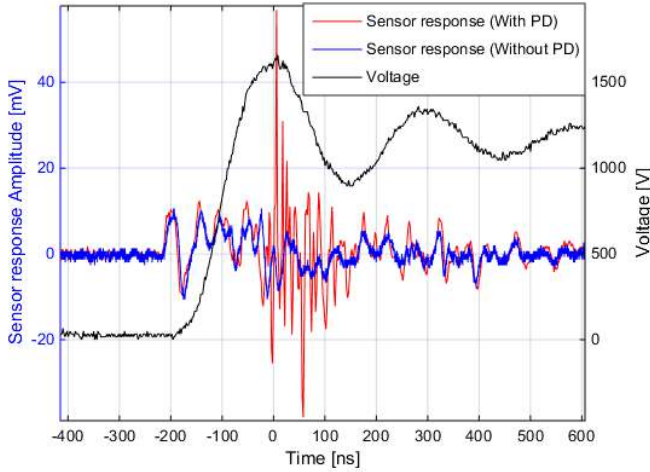

Fig. 9. Recorded antenna signals with and without PD.

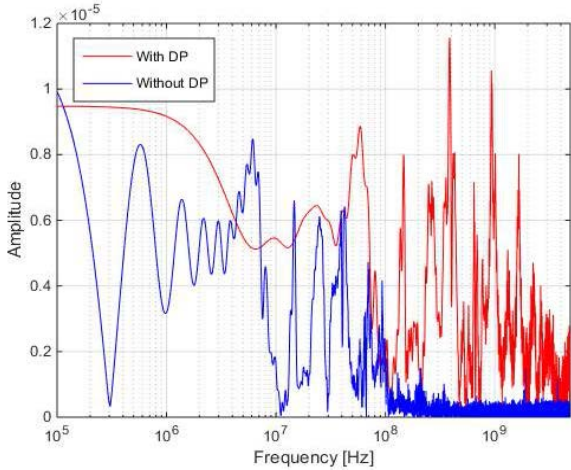

Fig. 10. FFT of the recorded signals with and without PD

PDIV value measured under PWM voltage is much higher, twice as high than under AC voltage. Short voltage rise time, and charge build-up on dielectric surface could account for this higher measured PDIV value. An average time delay between voltage application and discharge inception is governed by the probability of the presence of a seed electron in the air gap. With a fast rise voltage signal, this delay may lead to higher inception voltage value. Furthermore, insulator surface charge build-up due to charges produced in gas phase by ionization processes creates an electric field in opposite direction to the unipolar applied field, thereby minimizing the actual resulting electric field in the gas gap.

TABLE I. EXPERIMENTAL PDIV VALUES

	AC 50Hz	PWM	Model
Mean ( $V_{max}$ )	<b>820</b>	<b>1690</b>	<b>830</b>
Std. deviation (V)	<b>45,6</b>	<b>43</b>	/

#### IV. CONCLUSION

In this study, we attempted to predict the partial discharge activity within two parallel magnet wires. In a first stage, a 2D electrostatic FEM-based model is performed. The simulation results show that the presence of voids within the winding impregnation can be equivalent to the case without impregnation, in term of breakdown voltage. For this reason, we made the choice to work with non-impregnated wires and therefore consider the worst case.

Using coaxial cable sensor in a shielded environment seems to be an efficient way to detect PDs under PWM controlled voltage. One of the main findings in this study is the filtering method. High pass filtering can be achieved in a simple way using the properties of modern oscilloscopes, as the experimental results show that PD signatures can be dissociated from the noisy signal without altering the quality of the signal. This method is an efficient and low cost way for PD detection.

Further work is being undertaken. One of the key parameters of the proposed PD prediction method is the relative permittivity of the insulation material. A precise knowledge of this value and its variation with temperature and humidity is particularly being looked at. Another direction of investigation is the excitation signal polarity. Indeed, we are currently constructing an H-bridge so as to evaluate the PD activity under bipolar PWM controlled voltage. Besides, transposing our PD prediction method to a full traction machine winding, considering different winding configurations and magnet wire shapes, is also being investigated.

#### REFERENCES

- [1] P. Bidan, T. Lebey, G. Montseny, and J. Saint-Michel, "Transient voltage distribution in inverter fed motor windings: experimental study and modeling," *IEEE Trans. Power Electron.*, vol. 16, no. 1, pp. 92–100, 2001.
- [2] L. Benmamas, P. Teste, F. Vangraefschep, G. Krebs, E. Odic, T. Hamiti, and E. Berthelot, "Validation d'un modèle de bobinage par analyse fréquentielle et temporelle," in *Symposium de Génie Électrique (SGE)*, 2016.
- [3] G. Dakin, T.W. Luxa, G. Oppermann, G. Vigreux, "Breakdown of gases in uniform fields Paschen curves for nitrogen air and sulfure hexafluoride," *Electra*, vol. 32, pp. 61–82, 1974.
- [4] F. Paschen, "Ueber die zum Funkenübergang in Luft, Wasserstoff und Kohlensäure bei verschiedenen Drucken erforderliche Potentialdifferenz," *Ann. Phys.*, vol. 273, no. 5, pp. 69–96, 1889.
- [5] S. Duchesne, J. Moeneclaey, G. Vêlu, and D. Roger, "Is thermo - bonded coils a good solution for electric machines fed by fast PWM inverters?," in *Electrical Insulation Conference*, 2014, pp. 425–429.
- [6] A. Anton, "Caractéristiques électriques des matériaux isolants," *Tech. l'Ingénieur*, vol. 33, 2003.
- [7] T. Billard, "Off-line and On-line Partial Discharges Detection in Low Voltage Motors of Electric Vehicle fed by a PWM Inverter using Non-Intrusive Sensor," Université de Toulouse, Laplace, 2014.
- [8] C. Abadie and T. Billard, "Influence of pressure on partial discharge spectra," in *Electrical Insulation Conference*, 2016, pp. 507–510.