



HAL
open science

Fundamentals and applications of Laser Induced Plasma Spectroscopy

Laurent Zimmer

► **To cite this version:**

Laurent Zimmer. Fundamentals and applications of Laser Induced Plasma Spectroscopy. Journal of the Combustion Society of Japan, 2019. hal-02407093

HAL Id: hal-02407093

<https://centralesupelec.hal.science/hal-02407093>

Submitted on 12 Dec 2019

HAL is a multi-disciplinary open access archive for the deposit and dissemination of scientific research documents, whether they are published or not. The documents may come from teaching and research institutions in France or abroad, or from public or private research centers.

L'archive ouverte pluridisciplinaire **HAL**, est destinée au dépôt et à la diffusion de documents scientifiques de niveau recherche, publiés ou non, émanant des établissements d'enseignement et de recherche français ou étrangers, des laboratoires publics ou privés.

Fundamentals and applications of Laser Induced Plasma Spectroscopy

ZIMMER, Laurent^{1*}

¹ EM2C laboratory, CNRS - CentraleSupélec - Université Paris-Saclay, 8-10 rue Joliot Curie 91192 Gif-sur-Yvette, France

Abstract : The purpose of this article is to review the possibilities provided by the Laser Induced Plasma Spectroscopy measurement technique to get insights into gaseous or spray reacting systems under different working pressure. After a brief review and an overall presentation the requirements of the laser source and the detection systems are described. The processing of the spectral information is discussed before showing typical applications in gaseous, sprays and high-pressure environments. Finally, the potential of LI3PS (LIPS & Ignition & Interferometry) is presented and future directions for developments are given.

Key words : Laser Induced Plasma Spectroscopy, Droplets, Particles, Laser Ignition, Non-premixed systems

1. Introduction

Getting the local mixture fraction in various conditions is important to understand the dynamics of reacting flows and the formation of pollutant emissions. Whereas several measurement techniques may be available for specific conditions, few can be applied to a wide range encompassing low to high pressure, and able to deal with droplets or particles. Among them, the Laser Induced Plasma Spectroscopy (LIPS also called Laser Induced Breakdown Spectroscopy or LIBS) is a good candidate as requiring only one laser pulse and as it does not rely on a specific tuning of the laser wavelength. The principle is to focus the emission of a pulsed laser to achieve high enough irradiance to create a plasma. The spectral emission of the created plasma is acquired and typical ionic, atomic and/or molecular emission ratio can be linked to local mixture fraction after a proper calibration. Since the pioneering work [1], many improvements and applications have been proposed for combustion research.

The purpose of this paper is to review the requirements and possibilities of the LIPS technique applied to non-reacting and reacting flows. Typical optical requirements are first presented with an emphasis on the optical collection and recent developments in planar approaches are presented. The processing of the acquired spectral information is then discussed, showing the benefits of spectra simulations. Typical applications of mixture fraction measurements for gaseous or liquid fuel are reported. Finally, it is shown that a combined approach of interferometric particle imaging (IPI also called Interferometric Laser Imaging for Droplet Sizing

or ILIDS) technique with LI2PS using a single laser is a possible technique to characterise spray ignition events. Conclusions and perspectives are then drawn.

2. Optical setup

The overall setup for LIPS can be decomposed into three parts, as shown in figure 1. The optical setup of the LIPS is composed of two distinct parts : emission and collection. As far as the emission is concerned, one may differentiate the laser system (pulsed but not necessarily nano-second) to the focussing unit.

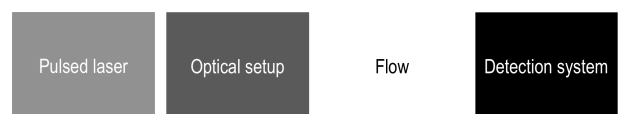

Fig 1. Overall layout of a LIPS setup

In most system, the simple optical arrangement is still used. The emission of the pulsed laser is directly focussed through a lens. Sometimes, it may be interesting to first use a divergent lens before focussing the beam for angular access or to use some spatial light modulators to be able to generate several plasma with a single lens and pulse. As far as the pulsed laser system is concerned, some investigations showed that polarising the initial laser seems to have some beneficial effects on the suppression of the background emission [2]. This may be an important aspect if non-gated detection system is used. Recently, it was shown that using femto-second laser is also an alternative to nano-second systems [3-4]. However, for practical cases, a Nd:YAG laser

is still the most popular system, either using its fundamental or the second harmonic generated wavelength. Often, the energy of the pulse is monitored by a power-meter, using splitting mirrors to get 5 to 10% of the energy pulse. It may also be interested to record the temporal evolution of the pulse using fast photodiodes to obtain information of the temporal behaviour of the laser pulse, especially after plasma creation. However, this is not mandatory for the quantification of mixture fraction as self-calibration spectral analysis based on Boltzmann plot can be applied.

Much more attention has been drawn on the detection part for which many different possibilities exist to gather temporally, spatially and spectrally resolved light naturally emitted by the induced plasma. The emission of a laser induced plasma is known to strongly vary in time. After the inverse Bremsstrahlung process, initially intense ionic emissions (lasting less than 1 microsecond), followed by atomic and molecular emission (lasting few tens of microseconds) can be recorded. The absolute intensity is temporally decreasing so that typically, it is hard to detect a signal after 50 microseconds. The temporally resolved measurements are quite easy to develop as a precise timing of the occurrence of the laser induced plasma is known within a nano-second order. Most of the investigations reported have been obtained with gated detection system (usually triggered with a nanosecond resolution), even though non-gated sensors may be used for combustion applications [5], using similar emission line as gated techniques. The choice of the gating time is done to optimise the signal of emission of interest and typically a window ranging from 1 to 10 micro-seconds after the creation of plasma is chosen as the spectra is dominated by neutral atomic emissions, while avoiding the strong continuous emissions. This ensures a good signal to noise ratio. The exact dynamic of individual laser induced plasma is not important to measure for mixture fraction determination but preliminary studies based on the statistical temporal behaviour is required.

For spectrally resolved measurements, most of the systems are based on a spectrometer coupled to a camera (that can be intensified). High spectral resolution is usually not an important issue as the typical emissions do not overlap for the species of interest in combustion systems (C, H, N and O). If other elements are introduced, like Aluminium, a low spectral resolution will result in measuring at the same time several peaks of the ionic and atomic species. This may lead to difficulties in properly relating the intensity measured to elemental concentration. In most cases, it is therefore also possible to use interferential filters coupled to photo-

multiplier tubes to have a fully temporally resolved measurements with information some specific wavelengths, usually centred around hydrogen and oxygen [6]. Typical spectra of interest ranges between 200 and 900 nm and the spectral resolution may be low as the exact ro-vibrational distribution of molecular emission is not resolved (it can be as low as 2 nm). As several peaks are of interest in different part of the spectra, the low resolution is accompanied by a broader region, having typical gratings of 150 lines/mm. The quantum efficiency of the detection system has to ensure good signal to noise ratio in the visible part as well as in the near-IR region.

Spatial resolution is an important aspect in many systems. Compared to other laser diagnostics, the exact position and measurement volume of the LIPS can not be precisely controlled. Therefore, it is very important to measure it. Depending on the presence of impurities, like droplets or particles, plasma will be created at a different point as compared to the focal point of the optical system. Sometimes, one may even have several small plasma along the laser path. The volume is also influenced by the pulse energy, a higher energy leading to a longer volume. It also shows some temporal evolution due to thermal expansion of the plasma and its shape changes from elongated along the axis of the laser to elongated perpendicular to its initial propagation line. Therefore, the signal is possibly obtained in a different volume for each plasma (even with the same optical setup) and great care has to be addressed about this issue when applying LIPS to quantitative measurements. Limiting the signal to the overall plasma emission, as done in many applications, can neither tackle mixture fraction measurements within the plasma, nor the change in the position of the plasma. Furthermore many systems do have a collection at a right angle as compared to the laser pulse and may miss part of the signal due to the jitter in the position of the plasma. In order to estimate both the volume and the position, measurements with spatial resolution are required. This can be achieved with a spectrometer and an achromatic lens to collect the signal from the plasma, while keeping a 1-D spatial information, with a typical spatial resolution of about 100 μm [7]. The collection device is oriented in such a way that the spatial resolution is aligned with the laser pulse path. The main assumption is that the plasma has a negligible height as compared to the length and therefore gradients perpendicular to the propagation can be neglected. This hypothesis is no more valid with strong inhomogeneities in the medium, like in presence of solid particles or droplets. An alternative approach consists in using interferential filters in front of one (or more) camera to obtain spectrally resolved

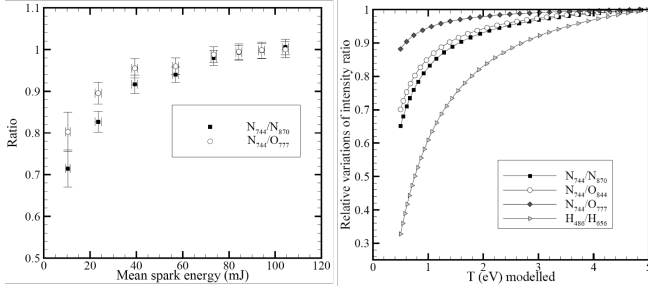

Fig 2. Comparison between experimental and theoretical ratio as function of plasma energy or temperature [10]

planar images of the plasma emission. This approach is called 2D-LIPS ([8]). This can also provide a more detailed quantification of the probe volume as it is actually acquired by the camera. In parallel to the imaging approach, it is better to also use a spectrometer to assess the amount of intensity measured by the camera that is induced by the desired electronic transition.

Once the signal has been acquired, it is important to use a proper data processing approach in order to relate the resolved plasma emission to the local mixture fraction measurements. The different possibilities as well as different cautions are addressed in the following section.

3. Data processing

Regardless the optical arrangement used to create and collect the emission of the plasma, the main assumption of LIPS is to relate the intensity of some ratio of emissions to the relative concentration of some species, leading to the measure of the local mixture fraction. To do so, it is mandatory to select one (or more) emission that can be related to the fuel and another emission linked to the oxygen (or air). For fuel, different choices are available, but typical measurements are based on hydrogen atomic emissions. This leads to a strong signal to noise ratio as only one electron exists and therefore, few lines are available. Other

$$I_{mn} = n_a A_{mn} g_m \frac{h\omega_{mn}}{8\pi^2} \exp\left(-\frac{E_{mn}}{k_b T}\right) \times \exp\left[-\frac{(\lambda - \lambda_{mn})}{2 \times slit}\right] \times QE$$

possibilities for fuel tracing are to use carbon-containing molecules (like CN [5]). For the oxidiser, oxygen is usually chosen as having also strong atomic emission in the near IR region. The emission ratio between fuel emission and oxidiser emission is computed and the calibration aims at providing the relation between those two quantities. It is first important to understand that each individual emission is linked to the convolution of the concentration of the species emitted with optical parameters and plasma properties, such as temperature in the following way:

where n_a is the number density of the atom (or ion), A_{mn} the oscillator strength, g_m the statistical weight of level m , ω_{mn} the transition frequency, λ_{mn} the wavelength in air for the transition, and k_b and h the Boltzmann's and Planck's constants respectively. The detailed parameters for the atomic or ionic transitions are available in the NIST database [9]. The first exponential encompassed the actual temperature T of the plasma as well as the energy E_{mn} required for the transition between the two states m and n . The second exponential reproduces the instrumental broadening for which slit corresponds to a numerical slit and QE corresponds to the quantum efficiency of the detection system at the given wavelength λ of interest. This QE can be obtained using a combination of calibrated lamp, like Mercury or Xenon to cover the complete spectra. This step is a key point for universal calibration scheme. The slit parameter takes into account the spectral dispersion of the overall collecting system and can be estimated by looking at the width of different atomic emissions, for which natural broadening could be neglected. It is obvious that one of the key parameter is the plasma temperature and simulations may be done to choose a priori the lines according to a strong or weak sensitivity to this parameter [10]. The ratio between the two Hydrogen emission α (656 nm) and β (486 nm) is very sensitive to the temperature of the plasma, whereas the ratio between Nitrogen (N(I) triplet around 744 nm) and Oxygen (O(I) triplet 777.2-777.5 nm) is only weakly influenced by the temperature of the plasma. This means that characterising the fuel by measuring H (α or β) will strongly be modified due to the temperature of the plasma (and therefore energy of the plasma for low ranges of energy) and therefore this quantity has to be measured for each spectra. It is always important to properly model the recorded spectra in order to measure the local conditions of the plasma. Simulating a complete spectra allows also to apply Principal Component Analysis strategies for getting mixture fraction and not only one or two specific ratio, providing a better quantification of the single shot uncertainty. The main assumption behind this approach is that plasma achieves local thermal equilibrium (LTE). As typical timing is of the order of hundreds of nano-seconds, LTE is achieved and simulations of spectra can rely on this hypothesis. For accurate simulation, it is better to only have one single temperature, meaning that those simulations are well suited for spectra acquired with a small exposure time. Otherwise, the temporal evolution of the temperature has to be taken into account in the simulation, leading to more uncertainties.

A typical evolution of the ratio between two emission lines is

plotted in figure 2. On the left side, the abscissa is the mean spark energy, as measured by the difference between initial and final energy of the laser beam. On the right part, the abscissa is the imposed temperature (in eV) for the simulation. Both normalised ratios are computed using the same bandwidth (+/- 5 nm around the peak of interest) with local background subtraction and their relative evolution is plotted in the ordinate of both graphs. It is clear from those comparisons that the theoretical behaviour of temperature dependence can be retrieved in the experimental results, emphasising the role of plasma energy on the spectra and subsequent emission ratio. This dependency is even more important for low energy, as shown in the left graph. Therefore, one would like to use high energy to void this effect but the higher the energy, the longer the probe volume and the stronger the induced shock-wave (that will ultimately disturb the flow). Therefore, to limit the plasma energy, it is important to have such an online estimation of the temperature.

Calibration curves are usually obtained in the same optical arrangements as the final measurement in order to take into account the different effects depicted in equation 1. Another common practice is to use relatively high energy to avoid being sensitive to variations of shot to shot properties. The deposit of high energy may influence the flow but the time scales under consideration for LIPS measurements are small enough to consider that the influence happens after the measurement. This limits the repetition rate of the technique and usual measurements are performed on a low repetition rate (of the order of 15 to 30 Hz). Despite using high energy, the plasma temperature may not be constant over the experiments due to variability in the properties within the measurement volume and therefore, it is important to propose some approaches to estimate the temperature for each individual acquisition. Typically, a Boltzmann plot is used to estimate the temperature by assuming local thermal equilibrium and the spectra may be conditionally analysed with respect to some determined ratio (like $\alpha - \beta$ of the Balmer's series [11]), showing a strong dependence on the temperature. This proves to be able to handle various light source in various flow conditions, regardless the initial temperature of the non-reacting mixture. This self-calibration can take into account variability in the laser pulse as well as different optical setup used to create the plasma, while keeping a good single-shot accuracy.

Many different ratios have been proposed for reacting flow analysis in both fresh and burnt gases environments. Among the most used for fuel, one can find H-Balmer series (either

α around 656 or β around 486 nm) or molecular C_2 band (around 516.5 nm). For oxidiser, several atomic lines of oxygen or nitrogen can be chosen. Other possibilities are based on molecular emission from CN (388.3 nm), if later acquisition time are investigated with combination of C_2 emission band [4]. Typical uncertainties can be estimated to be within 5% on a single-shot basis [11] with a proper timing and estimation of the plasma temperature. Recent processing strategies tend to have a ratio for lean mixture ($H\alpha/O$) and a different one for higher mixture fraction (C_2/CN) [5], requiring the simultaneous measurements of both ratios and defining a threshold to switch between the two for reliable measurements.

In the following, several different applications of LIPS to quantify local mixture fractions are presented with emphasis on the spatial resolution aspect, which remains a key issue for LIPS as measurement technique in reacting flows.

4. Typical applications

4.1 Gaseous cases

Quantifying the mixture fraction in gaseous flows using LIPS has recently gained interest due to the relative simplicity of the optical setup (both on the emission and collection side). However, few experiments ([4, 6,12]) have really addressed the issue of the measurement volume, taking usually only one mean value for the complete plasma.

To illustrate the possibilities for increased spatial resolution measurements, an imaging approach has been developed. The optical setup is composed of a single-pulse laser (Nd:YAG - 1064 nm - 8ns) and a double convex lens of focal length 150 mm (BICX-50.8-153.4-C, Melles Griot) and a plano-concave lens of focal length -50 mm. The concave lens is installed 11 mm before the converging lens and the resulting spark is created approximately 20 mm ahead of the

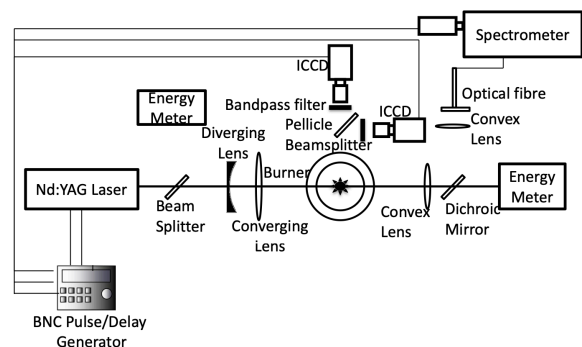

Fig. 3 Typical optical setup for 2D-LIPS measurement technique [8]

converging lens. Two intensified camera (PI-MAX,

Princeton Instruments, 512x512 px) having the same objectives, UV-NIKKOR 105 mm, 4.5 aperture) and equipped with a different bandpass filter (respectively FB660-10 (Thorlabs) and FB780-10 (Thorlabs), each having a bandpass of 10 nm) are placed perpendicular to the laser beam. A pellicle beam splitter (PBS-2C, Newport corporation), which provides 50-50 reflection transmission, was installed at 45 ° to both the cameras in order to obtain plasma images in both the cameras. A system of lens/fiber coupled to a spectrometer is used to measure the light emitted by the whole plasma, as shown in figure 3. Using the fundamental wavelength of the Nd:YAG offers the possibility of forward or backward spectral collection, having the fibre aligned with the laser path. A laminar burner is used to assess the spatial resolution and determine the typical uncertainties.

A band pass filter with 10 nm full width half maximum (FWHM) transmits a high percentage (at most 60%) of intensity for a wavelength range of about 20 nm. Thus, in order to calculate the atomic concentration as seen by the camera, it is important to know the amount of the desired atomic emission intensity present in the total intensity seen by the camera. Simultaneous emission spectra acquired by the spectrometer are used to obtain this information. The spectra recorded from a plasma emitting in a homogeneous gaseous condition is equivalent to the spatial integration of the emission recorded by the ICCD cameras. One can define a parameter (collecting efficiency α_λ) which provides the ratio of the intensity of the atomic/ionic emissions over the total intensity measured by the ICCD camera. α_λ will be equal to 1 if all the intensity of the ICCD is from the line of interest. It will be lower than 1 when some intensity due to background emission is also recorded. This parameter will be a function of spectra and time and can be computed knowing the transmission properties of the band pass filter mounted in front of the ICCD camera. Typical considerations of this parameter for three different atomic emissions (H, O and the emission of nitrogen around 744 nm) are displayed in figure 4 for a methane-air case at atmospheric condition. The averaged value over 100 spectra are used to get those statistics. One can see that this parameter is relatively weak for N(I) around 744 nm and remains constant for H α and O(I) for delays longer than 1500 ns after the plasma creation. For a 2D-LIPS, emission lines having constant and a collecting efficiency α_λ higher than 0.5 should be chosen. On the other hand, one can notice that the plasma volume is changing with time and typically decreases after 3000 ns, leading to a lower measurement volume (estimated assuming cylindrical symmetry). The ratio between length to width (L/

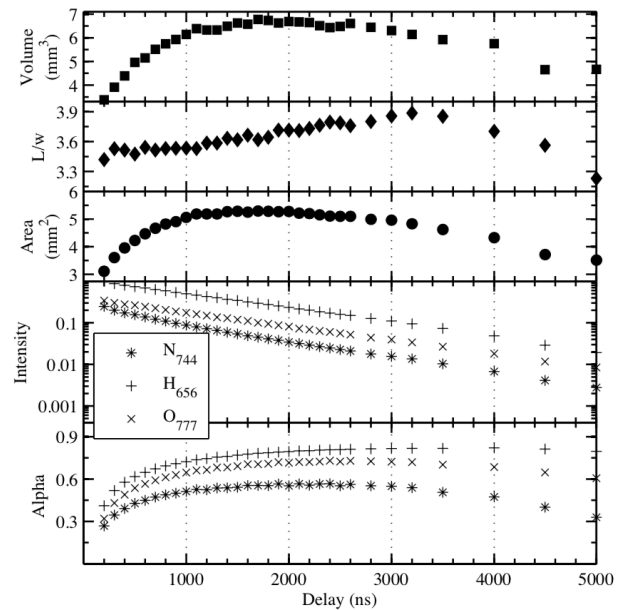

Fig. 4 Temporal variation of plasma characteristics and the 2D-LIPS collecting efficiency α_λ for three different atomic emissions [12]

w) does not show any specific trend, leading to a relatively constant shred probe volume. On the other hand, one can also clear notice the fast decrease of the emissions, the intensity is plotted using a log-scale. As the purpose is to have spatially resolved mixture fraction, the bigger the overall measurement volume, the better, while having a good collecting efficiency. Therefore, it is suggested to have images acquired at a delay of 1500 ns with a gate of 90 ns.

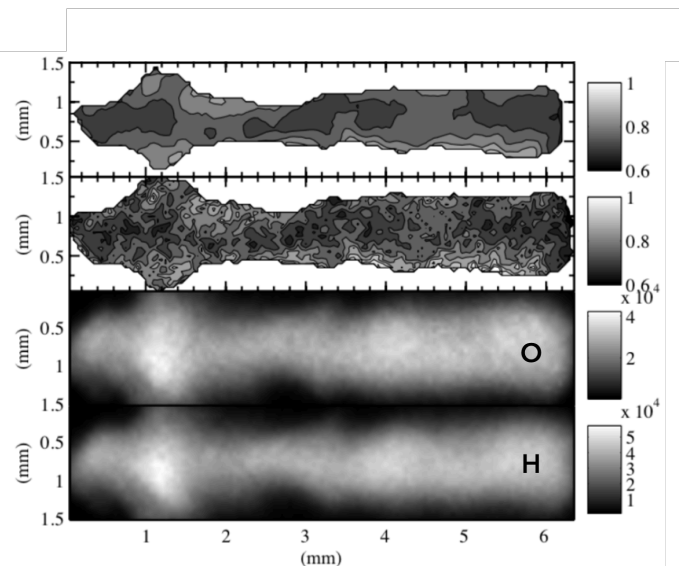
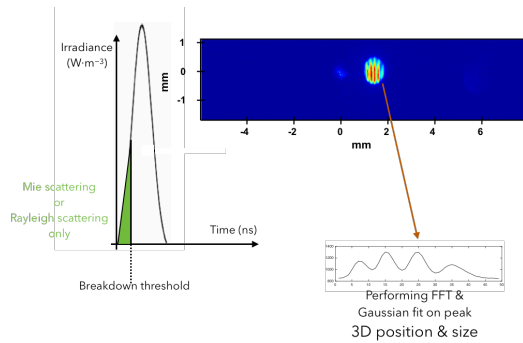

Fig. 5 Steps of intensity ratio calculation for a laser-induced plasma of spark energy 110.4 mJ, generated in an air-methane mixture of equivalence ratio 0.9. From bottom to top: (a) Image from camera 1 corresponding to hydrogen emission. (b) Image from camera 2 corresponding to oxygen emissions. (c) Intensity ratio obtained after division of images (O/H) (fluctuations 8.19 %). (d) Intensity ratio obtained after applying an average filter of size 4x4 pixels, therefore resulting in a spatial resolution of 200 μm instead of initial resolution of 50 μm (fluctuations 5.73 %) [13].

Once emission lines are chosen, a perfect pixel to pixel



alignment of the two cameras is required. This can be done using some seeding droplets together with a single-pulsed laser sheet and perform a cross-correlation (PIV-like) processing between the two views. Optical flow methods [14] enable further sub-pixel accuracy on the full array of the two ICCD.

After those spectral and spatial calibration steps, the two images can be processed and their intensity ratio computed to obtain planar mixture fraction measurements (see fig. 5). In this single-shot case, to limit the noise, ratio is not computed on a pixel to pixel base but on small windows of 4x4 pixel. The overall spatial resolution is then decreased to 200 μm but the typical fluctuations on H/O remains below 5% on a single-shot basis, all through the plasma region. The single-shot variation is about 8% in case of using pixel-to-pixel ratio. This imaging approach is also interesting as the spatial resolution and the accuracy can be adjusted to achieve a compromise as the higher the spatial resolution, the higher the uncertainty. Typically, for one single laser induced plasma, more than 100 measurement points can be obtained.

It is interesting to note that an alternative approach to the collecting efficiency (α_λ) parameter is to actually measure the background intensity with another imaging system and not using an overall collecting efficiency value. As two more views would be required, one may develop specific optical devices able to record simultaneously two or even four views, using several splitting strategies. Nevertheless, correcting mis-alignment would still require optical-flow approaches. This planar measurement has some advantages as compared to classical approaches but requires good optical access, that can be problematic in some situations as well as good image processing tools.

4.2 Sprays

The presence of an heterogenous phase has a strong impact on LIPS behaviour. The typical irradiance required to achieve breakdown is much lower in presence of a second phase and may lead to simultaneously multiple sparks with a single laser pulse. One may take advantage of the lower

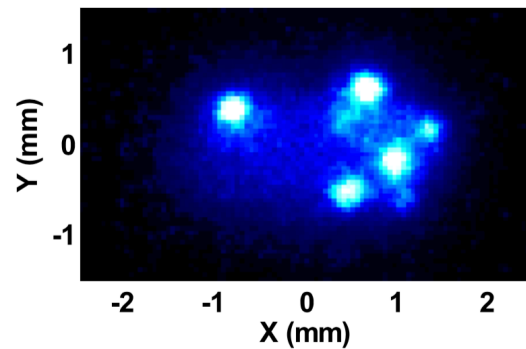

breakdown threshold to only create plasma within the dispersed phase, with no or little breakdown emission occurring for the gaseous molecules [15-16]. This phase-selective laser-induced breakdown spectroscopy is able to provide concentration measurements and typically a laser sheet is used with a high laser energy rather than a single focussing lens. However, if equivalence ratio is required, one has to simultaneously measure fuel and oxidiser and this would not give any information on the reactant parts, or regions where the droplets have evaporated. To investigate two-phase flows, the optical setup is not different from the

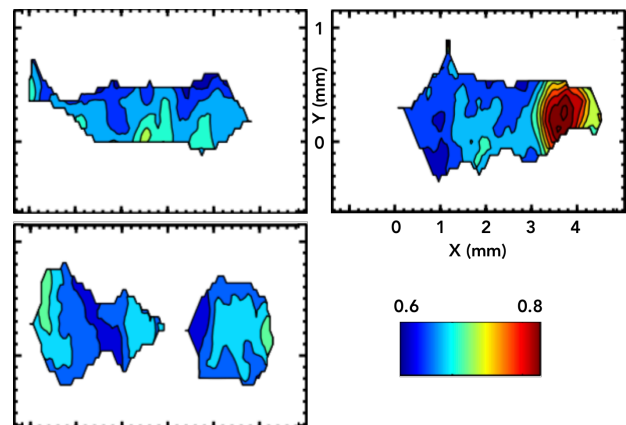
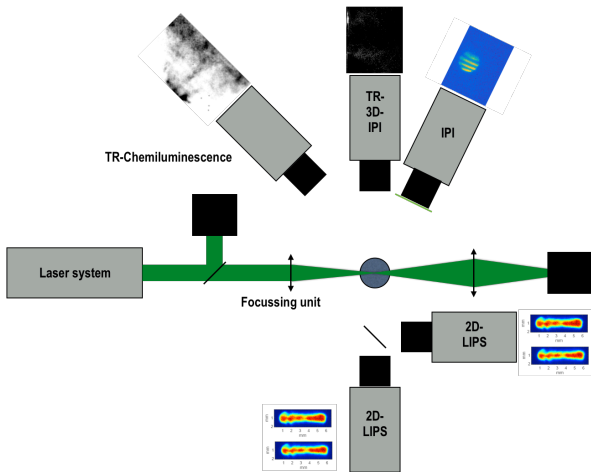

Fig. 7 Mixture fraction measurements in a non-reacting two-phase flow [13]

previously introduced one (fig. 2). As far as the flow is concerned, the difference resides in the introduction of fuel droplets (dodecane) with an arithmetic mean diameter of 15 μm and a mean Sauter diameter of 19 μm at an overall volume fraction of 10^{-4} . Using planar information, the effects of droplets on the plasma geometry and characteristics can be computed. A typical single-shot image is presented in figure 6, where one can see several spherical shaped zones with intense signal, corresponding to droplet induced plasma.

Those are characteristics of droplets and it is sometimes possible to have plasma created in the vicinity of a droplet at distances up to 5 mm from the actual focal point ($X=0\text{mm}$). This emphasises the need to have spatially resolved technique when applying LIPS to spray. A typical processing



of single shot images ($H\alpha/O(I)$ ratio) is presented in figure 7. One can clearly distinguish the high mixture fraction on the right side of the upper right plasma. The region with high mixture fraction has almost a spherical shape, meaning plasma was created in a region containing a droplet. On the lower left case, one can see that two plasma can be created in this two-phase flow, reinforcing the necessity to develop imaging strategies for LIPS in sprays, and recording the two lines of interest at the same time to get local mixture fraction in presence of droplets. However, this does not provide information on the size of the droplets before plasma creation. To do so, it is possible to combine LIPS with an interferometric particle imaging measurement technique [18]. With a proper timing, it is possible to record the Mie scattering of droplets induced by the laser that will actually create the plasma, as illustrated in fig. 8. Indeed, within the first nano-second, the local irradiance is not high enough to induce breakdown, even in presence of droplets. However, the elastic scattering by the droplets can be recorded with an intensified camera with a nano-second order gating time. It is known that the number of fringes within the image of the droplet is proportional to the physical size of the droplets, whereas its apparent size on the image is a function of the spatial localisation of the droplet with respect to the focal plane [19]. It is therefore possible to simultaneously record the measurements of actual size and position of all droplets that interact with the laser beam 1 nano-second before the creation of the plasma. Hence, with a single pulse, one has information on droplets characteristics before plasma and information on local mixture fraction using the aforementioned 2D-LIPS approach. This can provide a good information in reacting flows where those two quantities are usually difficult to measure at the same time. It is interesting to note that this does not need any specific laser or additional dye introduced to the liquid. Also, using only one laser, there is no mis-alignment issue in this technique and the IPI and

Fig. 10 Multi time-resolved diagnostics for spray ignition dynamics

$$\phi(\nu - \nu_0) = AK(x, y)$$

$$A = \frac{1}{\Delta\nu_D} \sqrt{\ln(2)/\pi}$$

$$K(x, y) = \frac{y}{\pi} \int_{-\infty}^{\infty} \frac{\exp(-t^2)}{y^2 + (x-t)^2} dt$$

$$y = \frac{\Delta\nu_L}{\Delta\nu_D} \sqrt{\ln(2)}$$

$$x = [(\nu - \nu_0)/\Delta\nu_D] \sqrt{\ln(2)}$$

LIPS have similar probe volume. Even droplets not in the plasma will be recorded by the IPI technique.

4.3 High-pressure environments

One knows that spectra tend to be broadened with an increase of pressure. The broadening of the different emission lines is determined by a convolution of Lorentzian (Stark, van der Waals, resonance and natural) and Gaussian (Doppler and instrumental) mechanisms that result in a Voigt profile when both mechanisms are of the same importance. The Voigt function may be expressed as

where ν_D and ν_L (in cm^{-1}) are Doppler and pressure broadening half-widths at half-maximum of the transition centred at ν_0 , and t is a variable of integration. Measurements in high-pressure cells proved to provide good signal to noise ratio, while the plasma size was decreasing for a constant laser energy [20]. The volume may be on order of magnitude lower at 5 MPa as compared to 0.1 MPa. It was already assessed that LIPS can be used to investigate several

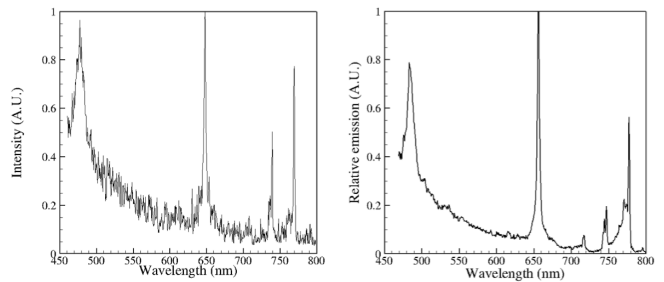

Fig. 9 Instantaneous (left) and averaged spectra (over 141 shots) in a kerosene/air middle pressure case burned gases. Time after plasma creation 300 ns and integration time 2 000 ns.

practical combustion systems. For instance, typical spectra obtained at a pressure of 0.35 MPa with kerosene/air flow are displayed in figure 9. The left side shows a single-shot, whereas the right part displays the average over 141 shots. One can clearly identify precisely the different atomic emission ($H \alpha$ and β , $N(I)$ and $O(I)$), even in the case of measurements performed in the burned gases. The calibration at higher pressure is similar to the strategies at ambient pressure. Simulating the effect of pressure requires adapting the slit parameter to take into account the broadening of the emission line. Due to higher

recombination rate, molecular emission appear earlier as compared to ambient pressure and may provide a good signal to noise ratio in rich regions.

5. 2D-LI3PS : Combined Interference - Ignition - LIPS

Ignition of non-premixed flow remains an issue as the exact condition of the energy deposit is not precisely controlled. As the purpose of LIPS is to create a plasma, it is possible to use this technique to actually ignite a mixture and get relevant information on the local mixture fraction. This has proven to be of interest to understand success or failure of laser-induced ignition in hydrogen-air combustion chamber [10]. In presence of sprays, it is of interest to have information of the mixture fraction but also on the size and position of droplets before the creation of plasma. A way to obtain such information is based on combined IPI and LIPS technique.

It is then possible to combine several diagnostics to better characterise the (laser) ignition of sprays. An example of such combination is shown in figure 10, where time-resolved 3D-IPI (TR-3D-IPI) obtained with a high speed camera and a continuous laser (or a pulsed laser) can be simultaneously applied to LI3PS technique to get the real experimental dynamics of the droplets during an ignition event. The laser for TR-3D-IPI would be shaped so as to measure a cylindrical volume around the Laser Induced Plasma. Chemiluminescence signals may also be acquired to have some information on the dynamics of the flame, leading to a better description of the ignition process, using only two lasers. This experimental setup may provide interesting information for modellers and even droplet secondary break-up could be measured with a 3D-IPI.

6. Conclusions

Despite of the relative simplicity of the optical setup, quantitative measurements using LIPS offers many challenges and opportunities. To achieve good accuracy, the simulation of plasma emission seems to be a good solution, requiring an accurate modelling of the detection setup. Applying LIPS in gaseous conditions or to higher pressure does not show any specific problems. For two-phase flow cases, it seems interesting to combine LIPS with interferometric particle imaging to get simultaneously position and sizes of droplets together with local mixture fraction within the same probe volume. Finally, LIPS may be used not only as a measurement technique but also as an ignition system. It offers unique possibilities to measure actual equivalence ratio in the spark, providing crucial

information for modelling ignition events.

References

1. Schmieder RW, T., *Report No. SAND81-8886, Sandia National Laboratories* (1981).
2. Eslami Majd, A., Arabanian, A.S. and Massudi, R., *Opt. Lasers Eng.* 48: 750-753 (2010).
3. Kotzagianni, M. and Couris, S. *Appl. Phys. Lett.*, 26: 264104 (2012)
4. Zhang, D., Gao, Q., Li, B., Zhu, Z. and Li, Z., *Opt. Express*, 27: 2159–2169 (2019)
5. Kotzagianni, M., Yuan, R., Mastorakos, E. and Couris, S. *Combust. Flame*, 167:72-85 (2016)
6. Buschbeck, M., Büchler, F., Halfmann, T. and Arndt, S., *Spectrochim. Acta B At. Spectrosc.*, 74-75:103-108 (2012)
7. Wu, Y., Gragston, M., Zhang, Z., Hsu, P.S., Jiang, N., Patnaik, A.K., Roy, S. and Gord, J.R., *Combust. Flame*, 198:120-129 (2018)
8. Agarwal, T and Zimmer, L, *16th Int Symp on Applications of Laser Techniques to Fluid Mechanics*, (2012)
9. NIST electronic database, at http://physics.nist.gov/PhysRefData/ASD/lines_form.html
10. Zimmer, L, Okai, K and Kurosawa, Y, *Spectrochim Acta B: At. Spectrosc.*, 62:1484-1495 (2007)
11. Zimmer, L and Tachibana, S., *Proc. Combust. Inst.*, 31: 737-745 (2007)
12. Kawahara, N., Beduneau, J.L., Nakayama, T., Tomita, E. and Ikeda, Y, *Appl. Phys. B*, 86: 605-614 (2007)
13. Agarwal, T (2013) PhD thesis, Ecole Centrale Paris.
14. Sun, D, Roth, S and Black, MJ, *Int. J. Comput. Vision*, 106:115-137 (2014).
15. Zhang, Y, Xiong, G, Li, S., Dong, Z and Buckley, SG and Tse, SD, *Combust. Flame*, 160: 725 - 733 (2013)
16. Jun HM, Suh SW and Yoh JY, *Opt. Express*, 27:5144 (2019)
17. George, R (2017) PhD Thesis, Université Paris-Saclay
18. Glover, AR, Skippon, SM and Boyle, RD, *Appl. Opt.*, 34:8409-21 (1995)
19. Damaschke, N., Nobach, H., Nonn, T.I., Semidetnov, N. and Tropea, C., *Exp. Fluids*, 39: 336-350 (2005)
20. Zimmer, L. and Yoshida, S., *Exp. Fluids*, 52: 891-904 (2012).