



HAL
open science

A Discrete-Time PID-like Consensus Control: Application to the Wind Farm Distributed Control Problem

Nicolo Gionfra, Guillaume Sandou, Houria Siguerdidjane, Damien Faille,
Philippe Loevenbruck

► **To cite this version:**

Nicolo Gionfra, Guillaume Sandou, Houria Siguerdidjane, Damien Faille, Philippe Loevenbruck. A Discrete-Time PID-like Consensus Control: Application to the Wind Farm Distributed Control Problem. O. Gusikhin and K. Madani. Informatics in Control, Automation and Robotics, 495, pp.106-134, 2019, Lecture Notes in Electrical Engineering, 10.1007/978-3-030-11292-9_6 . hal-02861064

HAL Id: hal-02861064

<https://centralesupelec.hal.science/hal-02861064v1>

Submitted on 8 Jun 2020

HAL is a multi-disciplinary open access archive for the deposit and dissemination of scientific research documents, whether they are published or not. The documents may come from teaching and research institutions in France or abroad, or from public or private research centers.

L'archive ouverte pluridisciplinaire **HAL**, est destinée au dépôt et à la diffusion de documents scientifiques de niveau recherche, publiés ou non, émanant des établissements d'enseignement et de recherche français ou étrangers, des laboratoires publics ou privés.

A Discrete-Time PID-like Consensus Control: Application to the Wind Farm Distributed Control Problem

Nicolò Gionfra¹, Guillaume Sandou, Houria Siguerdidjane,
Damien Faille², and Philippe Loevenbruck³

¹ Laboratoire des Signaux et Systèmes (L2S, CentraleSupélec, Université
Paris-Saclay), 91192 Gif-sur-Yvette, France,
{nicolo.gionfra, guillaume.sandou,
houria.siguerdidjane}@centralesupelec.fr

² EDF R&D, Department PRISME, 78401 Chatou, France,
damien.faille@edf.fr

³ EDF R&D, Department EFESE, 91120 Palaiseau, France,
philippe.loevenbruck@edf.fr

Abstract. The problem of discrete-time multi-agent systems governed by general MIMO dynamics is addressed. By employing a PID-like distributed protocol, we aim to solve two relevant consensus problems, namely the leaderless weighted consensus under disturbances and leader-follower weighted consensus under time-varying reference state. Sufficient conditions for stability as well as a LMI approach to tune the controller gains are provided. The two consensus techniques are then applied to solve two issues concerning the wind farm (WF) power maximization problem under wake effect. Leaderless consensus aims at averaging out zero-mean wind disturbance effects on the optimal WF power sharing, while leader-follower control is employed to restore it in the case of power reference errors. Simulations are carried out on a small WF example, whose units are the NREL's CART wind turbines.

Keywords: consensus control, multi-agent systems, wind farm, wake effect

1 Introduction

In recent years much research effort has been devoted to the area of multi-agent cooperative control because of its wide range of applications and potential benefits. Cooperation of a coordinated multi-agent network is sought via distributed algorithms as they present some interesting advantages over their centralized counterpart, e.g. avoiding single point of failure, reducing communication and computational burden, etc. The main problem in distributed coordination, known as *consensus* problem, is the one of achieving an agreement on some variables of interest, named *coordination* variables, of each agent via

local interactions. These variables evolve according to a prescribed dynamics describing the physics of the problem, while interactions among agents are defined by a given communication graph. Finding a distributed protocol to solve the aforementioned problem has been extensively treated for single and double integrator dynamic agents, e.g. [1]. However, in a more general framework, general dynamics need to be considered in order to describe the agents behavior.

The consensus problem for this latter case has been discussed for both continuous and discrete-time multi-agent systems. In addition, it can be further divided in two main classes of problems, namely leaderless and leader-follower ones. As far as the former is concerned, the most employed distributed protocol is given by a static state feedback law, also called P-like distributed control. One can cite, for instance, [2–4] for the continuous-time framework, and [3, 5–7] for the discrete one, where the consensus problem is led back to the one of simultaneously stabilizing multiple LTI systems. References [3, 6] also solve a leader-follower problem where the leader has an autonomous time-invariant dynamics. Another interesting problem is the one of finding the optimal P-like protocol gain in order to improve consensus under system uncertainties, as in [8], and disturbances as in [9, 10], for continuous time systems, and [11] for discrete-time ones. The proposed approaches usually make use of some \mathcal{H}_2 or \mathcal{H}_∞ constraints to be respected, and they are in general more involved than the one of simultaneously stabilizing multiple systems. For instance, [10] provide necessary and sufficient conditions, for the continuous-time case to solve the consensus problem while guaranteeing some properties on the aforementioned norms. On the other hand, for discrete-time systems only sufficient conditions are provided using results from robust control as in [11]. Dynamic distributed controllers are also proposed for consensus achievement based on local output measurements, e.g. [3]. In the continuous-time framework, [12] provide a controller with limited energy, while a general full order one is presented in [13] to achieve some \mathcal{H}_∞ performance. Other possible structures have been explored too. Indeed, given the common P-like controller, one can easily think of a more general PID-like structure. In continuous-time, for instance, [14] propose a PI-like distributed algorithm for single integrator dynamic agents, and [15] provide a PID-like controller for general high-order SISO systems. Similar control design is applied to solve a leader-follower consensus under time-varying reference state, as in [16], and in its sampled-data counterpart [17], where a PD-like protocol is given. Even though the presented literature review is nowhere near exhaustive, one can remark that poorer attention has been devoted to discrete-time dynamic protocols for general LTI MIMO systems, and this is on what we wish to focus our attention in the sequel.

In this chapter our first contribution concerns the proposal of a PID-like distributed controller for the aforementioned systems, and we provide a possible way of tuning the controller parameters based on the solution of LMIs. The results here presented have been object of our previous work in [18], where we treated the problems of *leaderless consensus under the presence of disturbances*, and *leader-follower consensus under a time-varying reference state*. Differently from

the aforesaid work, here we propose a generalized control technique in order to treat *weighted* consensus problems, i.e. those multi-agent systems in which consensus has to respect predefined gains, which determine given distances among the coordination variables. Despite being similar to what we already presented, this additional step reveals to be necessary to tackle a great variety of real-world problems such as the one considered in this chapter, namely the *wind farm distributed control problem*.

Our second main scope of this work is indeed concerned with applying the proposed consensus techniques for the sake of controlling a wind farm. In particular, we focus on the issues related to the *power maximization* problem for those wind farms experiencing the so-called *wake effect*. In such case, it turns out that considering the aerodynamic coupling among the wind turbines (WTs) leads to potential power gains when maximizing the power production, (see e.g. [19]), and justifies a growing interest in *cooperative* methods to control them. Typically the problem of power maximization under wake interaction is handled via a first step of optimization under the assumption of a static system. This approximation is mainly due to the high nonconvexity of the wake model that makes the problem hard to be treated directly under a control perspective. Here, cooperation is reached by considering a common WF optimization problem among the WTs rather than a more classic *greedy* WT optimization such as the *maximum power tracking point* (MPPT) operating mode. The overall WF control architecture thus exhibits a two-layer hierarchical structure, where the higher control level is concerned with providing optimal power references to the local WT controllers. These are then operated in *decentralized* mode, i.e. once received the power reference to track, no additional cooperation is performed among the WT controllers. In this chapter we claim that allowing additional cooperation also at the WT control level can lead to interesting benefits. In particular we show how cooperation at the lower level can be achieved via the consensus control techniques object of the first part of this chapter. Thus, the lower control considered in this work is thus said to be *distributed*.

It is important to point out that wind farm power maximization can be alternatively seen as the problem of finding the optimal *power sharing* of the available wind source among the WTs. Similar power sharing problems for wind farms have been treated in [20–22]. Based on the common assumption that the available wind power is higher than the demanded one, and with no wake effect consideration, they employ different distributed control approaches to deal with the problem of meeting the desired WF power output. The distributed WF control approach here presented addresses the problem of allowing proper power sharing among the WTs, enhancing the respect of the imposed higher level power gains despite the system dynamics and the presence of wind disturbances. Even if it has some common ideas, it substantially differs from the mentioned references either in the problem addressed and in the control techniques proposed to tackle it. The developments here proposed have been suggested in our preliminary work of [23]. Nonetheless, in this chapter, these are extended by considering new wind farm control applications and the theorems shown therein are here provided with

the according proof.

The remainder of the chapter is organized as follows. Sections 2 and 3 are devoted to the leaderless and leader-follower techniques respectively. The wind farm control problem is introduced in Section 4, while its control design is described in Section 5. Simulations are shown in Section 6. The chapter ends with conclusions and future perspectives in Section 7.

2 Leaderless Consensus Under the Presence of Disturbances

2.1 Problem Formulation

In the sequel, the reader may refer to Appendix 1 for basic notions and definitions concerning graph theory. We consider N identical agents governed by general discrete-time linear dynamics, according to

$$\begin{cases} x_i^+ = Ax_i + B_2u_i + B_1\omega_i, & i = 1, \dots, N \\ y_i = Cx_i \end{cases} \quad (1)$$

where $A \in \mathbb{R}^{n \times n}$, $B_2 \in \mathbb{R}^{n \times l}$, $B_1 \in \mathbb{R}^{n \times h}$, $C \in \mathbb{R}^{m \times n}$, $x_i \triangleq x_i(k) \in \mathbb{R}^n$ and $x_i^+ \triangleq x_i(k+1) \in \mathbb{R}^n$ are respectively the agent state at the current step k , and at the next step $k+1$, $u_i \triangleq u_i(k) \in \mathbb{R}^l$ is the agent control, $\omega_i \triangleq \omega_i(k) \in \mathbb{R}^h$ its disturbance, and $y_i \triangleq y_i(k) \in \mathbb{R}^m$ is the measured output and the variable on which agreement among the agents is sought. Moreover we require the system to satisfy $l \geq m$, i.e. to have a greater or equal number of inputs with respect to its outputs. For the sake of leaderless consensus, a priori we do not require A to be Schur stable. Indeed, as shown in [7], A has a role in determining the consensus function to which the agents converge under proper control. Here it can be thought to be assigned by a previous control design step. The agents can communicate on an undirected connected graph whose Laplacian matrix \mathcal{L} has positive minimum nonzero and maximum eigenvalues respectively equal to $\underline{\lambda}_{\mathcal{L}}$, and $\bar{\lambda}_{\mathcal{L}}$. Thus, we can address the problem of finding a distributed control law for u_i such that $\|y_i/\chi_i - y_j/\chi_j\|$ is minimized for $i, j = 1, \dots, N$ with respect to the disturbance $\omega \triangleq \text{col}(\omega_1, \dots, \omega_N)$, and where *weight* $\chi_i \in \mathbb{R}^+$, $i = 1, \dots, N$, i.e. for the sake of simplicity of analysis we associate the same scalar weight to the whole controlled output vector. If error $y_i/\chi_i - y_j/\chi_j = 0$, $i, j = 1, \dots, N$, then we say that *weighted consensus* is achieved. By naming $D \triangleq \text{diag}(1/\chi_1, \dots, 1/\chi_N)$, we additionally define matrix $\hat{\mathcal{L}} \triangleq D\mathcal{L}$, which satisfies Lemma 3 in Appendix 1, and whose positive minimum nonzero and maximum eigenvalues are respectively $\underline{\lambda}_{\hat{\mathcal{L}}}$, and $\bar{\lambda}_{\hat{\mathcal{L}}}$. In this work we focus on local controllers of the form

$$\begin{cases} x_{c_i}^+ = A_c x_{c_i} + B_c s_i, & i = 1, \dots, N \\ u_i = C_c x_{c_i} + D_c s_i \end{cases} \quad (2)$$

where $x_{c_i} \triangleq x_{c_i}(k) \in \mathbb{R}^{2l}$ is the agent controller state, and

$$\begin{aligned} A_c &= \begin{bmatrix} I_l & I_l \\ 0_{l \times l} & 0_{l \times l} \end{bmatrix}_{2l \times 2l} & B_c &= \begin{bmatrix} (K_i - K_d) \\ K_d \end{bmatrix}_{2l \times m} \\ C_c &= [I_l \ 0_{l \times l}]_{l \times 2l} & D_c &= [(K_p + K_i + K_d)]_{l \times m} \end{aligned} \quad (3)$$

where $K_p = [k_{p,ij}]$, $K_i = [k_{i,ij}]$, $K_d = [k_{d,ij}] \in \mathbb{R}^{l \times m}$ are gain matrices to be tuned, and where $s_i \triangleq s_i(k) \in \mathbb{R}^m$ is defined as

$$s_i \triangleq \sum_{j=1}^N a_{ij} \left(\frac{y_i}{\chi_i} - \frac{y_j}{\chi_j} \right) \quad (4)$$

Thus the closed-loop system for agent i has dimension $\bar{n} \triangleq n + 2l$. As shown by [24], system (2) is a state representation of the discrete-time PID MIMO controller, whose z -transform between s_i and u_i is the transfer matrix $K_p + K_i \frac{z}{z-1} + K_d \frac{z-1}{z}$, where its generic element at position (i, j) is a PID whose gains are $k_{p,ij}$, $k_{i,ij}$, $k_{d,ij}$. The problem can be now restated as the one of finding matrices B_c , and D_c such that the effect of disturbance ω on the weighted consensus is minimized.

2.2 Fast Weighted Consensus

In our previous work of [18], we provided two possible ways to tune the distributed PID controller, the first of which being based on imposing a given \mathcal{H}_∞ constraint via LMIs on the closed-loop multi-agent system in order to minimize the additive disturbance effect on weighted consensus. In this work though we only focus on the second proposed possible way of tuning, which is concerned with achieving a multi-agent system *fast response* with respect to exogenous signals, such as disturbances, to reach weighted consensus. The two tuning techniques are quite similar, and the reader may refer to the mentioned reference for further details on \mathcal{H}_∞ consensus design.

Let us introduce the following

Definition 1. *System (1) is said to achieve fast weighted consensus with performance index $\tau \in \mathbb{R}^+$ if for $\omega = \mathbf{0}$, and any initial condition, $\lim_{k \rightarrow \infty} \|y_i/\chi_i - y_j/\chi_j\| = 0$ for $i, j = 1, \dots, N$, and $(1 - e^{-1})\%$ of consensus is achieved in a maximum number of steps equal to $\lceil \tau \rceil$.*

Note that the same kind of definition can be considered for *sampled-data* systems, by saying that system (1) achieves fast weighted consensus with a time constant inferior to τT_s , where T_s is the system sampling time.

The following result is based on Theorem 4 of [24] shown in the Appendix 2.

Theorem 1. *Given the system described by (1), where N agents can communicate on an undirected connected graph; consider the distributed protocol of equations (2),(3),(4); then the systems achieve fast weighted consensus with performance index $\tau = -1/\log(\psi)$, where $\psi \in \mathbb{R} : 0 \leq \psi < 1$, if there exist two symmetric*

positive definite matrices $\underline{P}, \bar{P} \in \mathbb{R}^{\bar{n} \times \bar{n}}$ such that the LMI conditions of Theorem 4 are simultaneously satisfied for two LTI systems whose dynamic, input, and output matrices are respectively $(A, B_2, \lambda_{\hat{\mathcal{L}}}C)$, and $(A, B_2, \lambda_{\hat{\mathcal{L}}}C)$, and where the real constants (a, b) to be set in Theorem 4 are chosen to be $(a, b) = (0, \psi)$.

Proof. In the sequel, the cited lemmas are shown in Appendix 1. The closed-loop dynamics for the generic agent i , by using (1),(2), and by defining the augmented state $\xi_i \triangleq \text{col}(x_i, x_{c_i}) \in \mathbb{R}^{\bar{n}}$, and matrices $\bar{C} \triangleq [C \quad 0_{m \times 2l}]$, $\tilde{B} \triangleq [B_1^\top \quad 0_{h \times (2l)}]^\top$ is given by

$$\begin{cases} \xi_i^+ = \hat{A}\xi_i + \hat{B} \sum_{j=1}^N a_{ij} \begin{pmatrix} \xi_i - \xi_j \\ \chi_i - \chi_j \end{pmatrix} + \tilde{B}\omega_i \\ y_i = \bar{C}\xi_i \end{cases} \quad (5)$$

where

$$\hat{A} = \begin{bmatrix} A & B_2 C_c \\ 0 & A_c \end{bmatrix}, \quad \hat{B} = \begin{bmatrix} B_2 D_c \bar{C} \\ B_c \bar{C} \end{bmatrix}$$

By naming $\xi \triangleq \text{col}(\xi_1, \dots, \xi_N)$, $y \triangleq \text{col}(y_1, \dots, y_N)$, gathering together the closed-loop agents dynamic, and performing the change of coordinates $\bar{\xi} = (D \otimes I_{\bar{n}})\xi$, it yields

$$\begin{cases} \bar{\xi}^+ = (I_N \otimes \hat{A} + D\mathcal{L} \otimes \hat{B}) \bar{\xi} + (I_N \otimes \tilde{B}) \bar{\omega} \\ \bar{y} = (I_N \otimes \bar{C}) \bar{\xi} \end{cases} \quad (6)$$

where we named $\bar{\omega} \triangleq (D \otimes I_h)\omega$, $\bar{y} \triangleq (D \otimes I_m)y$, and we used point (i) of Lemma 6. Similar to [13, 11], we define $\zeta_i \triangleq \bar{y}_i - \frac{1}{N} \sum_{j=1}^N \bar{y}_j$, and $\delta_i \triangleq \bar{\xi}_i - \frac{1}{N} \sum_{j=1}^N \bar{\xi}_j$. Thus $\zeta_i = \bar{C}\delta_i$. Note that if $\zeta_i = 0$ for $i = 1, \dots, N$ then $\bar{y}_i = \bar{y}_j$, i.e. weighted consensus is achieved. If we now name $\delta \triangleq \text{col}(\delta_1, \dots, \delta_N)$, and $\zeta \triangleq \text{col}(\zeta_1, \dots, \zeta_N)$, we have that $\zeta = (I_N \otimes \bar{C}) \delta$, and $\delta = \bar{\xi} - \mathbf{1} \otimes \frac{1}{N} \sum_{j=1}^N \bar{\xi}_j = (\bar{\mathcal{L}} \otimes I_{\bar{n}}) \bar{\xi}$, where $\bar{\mathcal{L}}$ satisfies the conditions of Lemma 2. Thus ζ and $\bar{\xi}$ variables are linked by relationship $\zeta = (I_N \otimes \bar{C}) (\bar{\mathcal{L}} \otimes I_{\bar{n}}) \bar{\xi} = (\bar{\mathcal{L}} \otimes \bar{C}) \bar{\xi}$. Considering the change of coordinates $\delta = (\bar{\mathcal{L}} \otimes I_{\bar{n}}) \bar{\xi}$ for system (6), it yields

$$\begin{aligned} \delta^+ &= (\bar{\mathcal{L}} \otimes I_{\bar{n}}) \left(I_N \otimes \hat{A} + \hat{\mathcal{L}} \otimes \hat{B} \right) \bar{\xi} + (\bar{\mathcal{L}} \otimes I_{\bar{n}}) \left(I_N \otimes \tilde{B} \right) \bar{\omega} \\ &= \left(\bar{\mathcal{L}} \otimes \hat{A} + \bar{\mathcal{L}} \hat{\mathcal{L}} \otimes \hat{B} \right) \left(\delta + \mathbf{1} \otimes \frac{1}{N} \sum_{k=1}^N \bar{\xi}_k \right) + (\bar{\mathcal{L}} \otimes \tilde{B}) \bar{\omega} \\ &= \left(\bar{\mathcal{L}} \otimes \hat{A} + \bar{\mathcal{L}} \hat{\mathcal{L}} \otimes \hat{B} \right) \delta + (\bar{\mathcal{L}} \otimes \tilde{B}) \bar{\omega} \end{aligned}$$

where we used points (i) of Lemma 2, 3, and 6. According to the (ii) point of Lemma 2, we employ the orthogonal matrix $U \in \mathbb{R}^{N \times N}$ to define the change of

coordinates: $\hat{\delta} \triangleq (U^\top \otimes I_{\bar{n}}) \delta$, $\hat{\omega} \triangleq (U^\top \otimes I_h) \bar{\omega}$, $\hat{\zeta} \triangleq (U^\top \otimes I_m) \zeta$, so that the system equations in the new coordinates are given by

$$\begin{cases} \hat{\delta}^+ &= (U^\top \otimes I_{\bar{n}}) \left(\bar{\mathcal{L}} \otimes \hat{A} + \bar{\mathcal{L}} \hat{\mathcal{L}} \otimes \hat{B} \right) (U \otimes I_{\bar{n}}) \hat{\delta} \\ &+ (U^\top \otimes I_{\bar{n}}) \left(\bar{\mathcal{L}} \otimes \tilde{B} \right) \hat{\omega} \\ &= \left(\bar{A} \otimes \hat{A} + \bar{A} U^\top \hat{\mathcal{L}} U \otimes \hat{B} \right) \hat{\delta} + \left(\bar{A} \otimes \tilde{B} \right) \hat{\omega} \\ \hat{\zeta} &= (U^\top \otimes I_m) (I_N \otimes \bar{C}) (U \otimes I_{\bar{n}}) \hat{\delta} = (I_N \otimes \bar{C}) \hat{\delta} \end{cases} \quad (7)$$

As shown in Lemma 2, and 3, being the last row and column of \bar{A} zeros, and the last column of $U^\top \hat{\mathcal{L}} U$ zero, we can split (7) in two by dividing the system variables as $\hat{\delta} = \text{col}(\hat{\delta}_1, \hat{\delta}_2)$, $\hat{\omega} = \text{col}(\hat{\omega}_1, \hat{\omega}_2)$, and $\hat{\zeta} = \text{col}(\hat{\zeta}_1, \hat{\zeta}_2)$. It follows that, to conclude on system stability, we can study the reduced order system described by

$$\begin{cases} \hat{\delta}_1^+ &= \left(I_{N-1} \otimes \hat{A} + \hat{\mathcal{L}}_1 \otimes \hat{B} \right) \hat{\delta}_1 + \left(I_{N-1} \otimes \tilde{B} \right) \hat{\omega}_1 \\ \hat{\zeta}_1 &= \left(I_{N-1} \otimes \bar{C} \right) \hat{\delta}_1 \end{cases}$$

From Lemma 3, it exists an invertible matrix $V \in \mathbb{R}^{(N-1) \times (N-1)} : V^{-1} \hat{\mathcal{L}}_1 V \triangleq \Lambda = \text{diag}(\lambda_1, \dots, \lambda_{N-1})$, where $0 < \underline{\lambda}_{\hat{\mathcal{L}}} \leq \lambda_i \leq \bar{\lambda}_{\hat{\mathcal{L}}}$ for $i = 1, \dots, N-1$. Thus we can define a further change of coordinates, such that $\tilde{\delta}_1 \triangleq (V^{-1} \otimes I_{\bar{n}}) \hat{\delta}_1$, $\tilde{\omega}_1 \triangleq (V^{-1} \otimes I_h) \hat{\omega}_1$, and $\tilde{\zeta}_1 \triangleq (V^{-1} \otimes I_m) \hat{\zeta}_1$. The latter yields

$$\begin{cases} \tilde{\delta}_1^+ &= \left(I_{N-1} \otimes \hat{A} + \Lambda \otimes \hat{B} \right) \tilde{\delta}_1 + \left(I_{N-1} \otimes \tilde{B} \right) \tilde{\omega}_1 \\ \tilde{\zeta}_1 &= \left(I_{N-1} \otimes \bar{C} \right) \tilde{\delta}_1 \end{cases} \quad (8)$$

We can now separate (8) in $N-1$ subsystems, each of them being governed by

$$\begin{cases} \tilde{\delta}_{1_i}^+ &= \begin{bmatrix} \tilde{x}_{1_i}^+ \\ \tilde{x}_{1,c_i}^+ \end{bmatrix} = \begin{bmatrix} (A + B_2 D_c(\lambda_i C)) & B_2 C_c \\ B_c(\lambda_i C) & A_c \end{bmatrix} \begin{bmatrix} \tilde{x}_{1_i} \\ \tilde{x}_{1,c_i} \end{bmatrix} + \begin{bmatrix} B_1 \\ 0 \end{bmatrix} \tilde{\omega}_{1_i} \\ \tilde{\zeta}_{1_i} &= C \tilde{x}_{1_i} \end{cases} \quad (9)$$

System (9) can be equivalently seen as the closed-loop form of the two following systems

$$\begin{cases} \tilde{x}_{1_i}^+ = A \tilde{x}_{1_i} + B_2 \tilde{u}_i + B_1 \tilde{\omega}_{1_i} \\ \tilde{y}_{1_i} \triangleq (\lambda_i C) \tilde{x}_{1_i} \\ \tilde{\zeta}_{1_i} = C \tilde{x}_{1_i} \end{cases}, \quad \begin{cases} \tilde{x}_{1,c_i}^+ = A_c \tilde{x}_{1,c_i} + B_c \tilde{y}_{1_i} \\ \tilde{u}_i \triangleq C_c \tilde{x}_{1,c_i} + D_c \tilde{y}_{1_i} \end{cases} \quad (10)$$

where \tilde{y}_{1_i} , and $\tilde{\zeta}_{1_i}$ are respectively the *measured* and *controlled* output variables of the controlled system. Thus, we can reformulate the problem as the one finding matrices B_c , and D_c such that for $i = 1, \dots, N-1$ the closed-loop system of (10) is Schur stable when $\omega_{1_i} = 0$. Moreover, since we are interested in speeding up consensus reaching with respect to exogenous signals, we want to push the overall closed-loop system eigenvalues closed to zero as much as possible. For

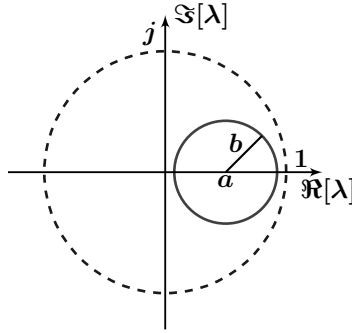

Fig. 1. \mathcal{F}_D region in the complex plane defined via parameters (a, b) .

this purpose we invoke Theorem 4, whose results can be directly applied to *one* generic system of the form of (10). Here it is shown that, given two constants $a \in \mathbb{R}$, and $b \in \mathbb{R}_0^+$, if there exists a symmetric positive definite matrix P_i such that the given LMI condition in the theorem is satisfied, then system (10) is stable with all its eigenvalues laying in the complex plane region defined by

$$\mathcal{F}_D \triangleq \{(\Re[\lambda], \Im[\lambda]) : (\Re[\lambda] + a)^2 + \Im[\lambda]^2 < b^2\}$$

where λ is the complex variable, (see Fig. 1). It is important to stress that the mentioned LMI conditions are *affine* in the system matrices, variables and matrix P_i . We make use of this fact to provide sufficient conditions for which it exists a controller of the considered form such that the mentioned LMI is *simultaneously* verified for $i = 1, \dots, N-1$. Since the generic eigenvalue of $\hat{\mathcal{L}}_1 : \lambda_i$ is such that $\underline{\lambda}_{\hat{\mathcal{L}}} \leq \lambda_i \leq \bar{\lambda}_{\hat{\mathcal{L}}}$, then it always exists $\alpha_i \in \mathbb{R} : 0 \leq \alpha_i \leq 1$ so that $\lambda_i = \alpha_i \underline{\lambda}_{\hat{\mathcal{L}}} + (1 - \alpha_i) \bar{\lambda}_{\hat{\mathcal{L}}}$. Notice that the systems to be stabilized, appearing in the first set of equation in (10), can be seen as *one* single system with an uncertain measurement matrix, whose parameter is λ_i . In other words, $C_i \triangleq \lambda_i C$, and $\exists \alpha_i : C_i = \alpha_i C_{low} + (1 - \alpha_i) C_{up}$, where $C_{low} \triangleq \underline{\lambda}_{\hat{\mathcal{L}}} C$, and $C_{up} \triangleq \bar{\lambda}_{\hat{\mathcal{L}}} C$, i.e. it can be written as a *convex combination* of the extreme matrices C_{low} , and C_{up} . Thus, as in [11], we make use of classic results of robust linear control, and in particular by introducing an affine parameter dependent Lyapunov matrix $P(\alpha_i) \triangleq \alpha_i \underline{P} + (1 - \alpha_i) \bar{P}$, where \underline{P} , \bar{P} are Lyapunov matrices solution of simultaneous LMI of Theorem 4 written for respectively C_{low} , and C_{up} . Thus, it is easy to show that if \underline{P} , \bar{P} exist, then the controller solves the problem $\forall \lambda \in \mathbb{R} : \underline{\lambda}_{\hat{\mathcal{L}}} \leq \lambda \leq \bar{\lambda}_{\hat{\mathcal{L}}}$, and in particular for $\lambda = \lambda_i$, for $i = 1, \dots, N-1$. Such a controller is easily found from the solution of the aforementioned LMI condition. Indeed among the LMI variables there are matrices B_c , and D_c , from which it is easy to deduce the PID gain matrices K_p , K_i , and K_d by employing relations in (3). Eventually, in order to place the closed-loop system eigenvalues closed to 0, we set $a = 0$, and $b = \psi$, where $\psi : 0 \leq \psi < 1$. Thus, all system eigenvalues are guaranteed to have a module inferior to ψ . As a result, the system has the slowest time-constant

inferior to $-T_s/\log(\psi)$. In terms of number of iterations, such performance is equal to a maximum value $\lceil -1/\log(\psi) \rceil$ of iterations. \square

Remark 1. If the mentioned LMI has a solution, then the closed-loop multi-agent system is guaranteed to be stable. In addition, having employed a PID structure for the distributed controller may suggest that consensus should be reached for any *constant* disturbance vector ω . Unfortunately, this is not automatically guaranteed in the MIMO case by the mentioned LMI conditions, and in this framework it is only verified *a posteriori*. Note that the MIMO PID controller is not block diagonal. Nonetheless, if such LMI has a solution then, according to the well-known Francis equations, a *necessary* condition for the proposed controller to reject constant exogenous signals is that $l \geq m$.

Remark 2. If the mentioned LMI has a solution and consensus is reached, still the disturbance has a role in determining the common function to which the agents converge, called *consensus function*.

3 Leader-follower Consensus with Time-varying Reference State

3.1 Problem Formulation

The results shown in Section 2 can be easily applied to solve the following leader-follower problem. Consider $N + 1$ discrete-time linear agents, whose dynamics are described by

$$\begin{cases} x_0^+ = Ax_0 + B_1u_0 \\ y_0 = Cx_0 \end{cases}, \quad \begin{cases} x_i^+ = Ax_i + B_2u_i, & i = 1, \dots, N \\ y_i = Cx_i \end{cases} \quad (11)$$

where $A \in \mathbb{R}^{n \times n}$, $B_1 \in \mathbb{R}^{n \times h}$, $B_2 \in \mathbb{R}^{n \times l}$, $C \in \mathbb{R}^{m \times n}$, $x_0 \triangleq x_0(k) \in \mathbb{R}^n$ is the state of the $N + 1$ agent, called *leader*, $y_0 \triangleq y_0(k) \in \mathbb{R}^m$ is its measured output and the variable on which we want the follower measured and controlled outputs y_i to converge, and $u_0 \triangleq u_0(k) \in \mathbb{R}^h$ is a time-varying unknown control acting on the leader dynamics. We additionally suppose that $l \geq m$. Concerning the remaining N follower agents, system description equivalent to (1) holds. The followers are assumed to communicate on an undirected connected graph whose Laplacian matrix is \mathcal{L} . The leader can pass information to a subset of followers. If agent i receives information from the leader, then we set a_{i0} to 1, and 0 otherwise. Thus we can define $\mathcal{M} \triangleq \mathcal{L} + \text{diag}(a_{10}, \dots, a_{N0})$, which is symmetric and positive definite. Differently from the leaderless consensus case, without loss of generality we consider A to be Schur stable. The aim of the present problem is indeed not the one of stabilizing each single agent, but rather to steer the follower agents state to the leader one despite the presence of u_0 , which makes the leader dynamics time-varying. Moreover, as done for the leaderless case, we consider the general case of weighted consensus. In other words we aim at finding a distributed control law to minimize $\|y_i/\chi_i - y_0/\chi_0\|$ for $i = 1, \dots, N$,

where $\chi_i, \chi_0 \in \mathbb{R}^+$. In order to accomplish such objective we aim to employ the controller of form (2), (3), where we consider a modified variable s_i to take into account the communication with the leader agent, according to

$$s_i = \sum_{j=1}^N a_{ij} \left(\frac{y_i}{\chi_i} - \frac{y_j}{\chi_j} \right) + a_{i0} \left(\frac{y_i}{\chi_i} - \frac{y_0}{\chi_0} \right) \quad (12)$$

Eventually, by using D , which we recall to be $D = \text{diag}(1/\chi_1, \dots, 1/\chi_N)$, we can additionally define $\hat{\mathcal{M}} \triangleq D\mathcal{M}$, which satisfies Lemmas 4, and 5, and it has minimum and maximum positive real eigenvalues equal to $\underline{\lambda}_{\hat{\mathcal{M}}}$, and $\bar{\lambda}_{\hat{\mathcal{M}}}$ respectively.

3.2 Fast Weighted Leader-follower Consensus

Similar to Definition 1, we provide the following

Definition 2. *System (11) is said to achieve fast weighted leader-follower consensus with performance index $\tau \in \mathbb{R}^+$ if for any initial condition, $\lim_{k \rightarrow \infty} \|y_i/\chi_i - y_0/\chi_0\| = 0$ for $i = 1, \dots, N$, when $u_0 = 0$, and $(1 - e^{-1})\%$ of consensus is achieved in a maximum number of steps equal to $\lceil \tau \rceil$.*

The following result, similar to Theorem 1, is based on Theorem 4 of [24] in the Appendix 1.

Theorem 2. *Given the system described by (11), where N follower agents can communicate on an undirected connected graph, and one leader can communicate with a non-empty subset of followers; consider the distributed protocol of equations (2),(3),(12); then the systems achieve fast leader-follower consensus with performance index $\tau = -1/\log(\psi)$, where $\psi \in \mathbb{R} : 0 \leq \psi < 1$, if there exist two symmetric positive definite matrices $\underline{P}, \bar{P} \in \mathbb{R}^{\bar{n} \times \bar{n}}$ such that the LMI conditions of Theorem 4 are simultaneously satisfied for two LTI systems whose dynamic, input and output matrices are respectively $(A, B_2, \underline{\lambda}_{\hat{\mathcal{M}}}C)$, and $(A, B_2, \bar{\lambda}_{\hat{\mathcal{M}}}C)$, and where the real constants (a, b) to be set in Theorem 4 are chosen to be $(a, b) = (0, \psi)$.*

Proof. The proof is similar to the one of Theorem 1. By defining error $e_i \triangleq x_i - x_0\chi_i/\chi_0$, $\xi_i \triangleq \text{col}(e_i, x_{c_i})$, and $\zeta_i \triangleq Ce_i$ the closed-loop system for the generic follower agent i is given by

$$\begin{cases} \xi_i^+ = \hat{A}\xi_i + \hat{B} \left(\sum_{j=1}^N a_{ij} \left(\frac{\xi_i}{\chi_i} - \frac{\xi_j}{\chi_j} \right) + a_{i0} \frac{\xi_i}{\chi_i} \right) + \chi_i \tilde{B}u_0 \\ \zeta_i = \bar{C}\xi_i \end{cases}$$

where $\hat{A}, \hat{B}, \bar{C}$ are defined in (5), and $\tilde{B} \triangleq [-B_1^\top/\chi_0 \quad 0_{h \times 2l}]^\top$. Defining $\mathbf{u}_0 \triangleq \mathbf{1}_N \otimes u_0$, and $\mathbf{u}_0 \triangleq (D \otimes I_{\bar{n}})\tilde{\mathbf{u}}_0$, we then gather the N agent equations together

$$\begin{cases} \xi^+ = \left(I_N \otimes \hat{A} + \mathcal{M}D \otimes \hat{B} \right) \xi + \left(I_N \otimes \tilde{B} \right) \tilde{\mathbf{u}}_0 \\ \zeta = \left(I_N \otimes \bar{C} \right) \xi \end{cases} \quad (13)$$

We consider the change of coordinates $\bar{\xi} \triangleq (D \otimes I_{\bar{n}})\xi$, and define $\bar{\mathbf{u}}_0 \triangleq (D \otimes I_{\bar{n}})\tilde{\mathbf{u}}_0$, $\bar{\zeta} \triangleq (D \otimes I_{\bar{n}})\zeta$, system (13) can be rewritten in the new coordinates as

$$\begin{cases} \bar{\xi}^+ = \left(I_N \otimes \hat{A} + \hat{\mathcal{M}} \otimes \hat{B} \right) \bar{\xi} + \left(I_N \otimes \hat{B} \right) \bar{\mathbf{u}}_0 \\ \bar{\zeta} = \left(I_N \otimes \bar{C} \right) \bar{\xi} \end{cases}$$

From the definition of $\hat{\mathcal{M}}$, there exists an orthogonal matrix $U : U^\top \hat{\mathcal{M}} U \triangleq \Lambda = \text{diag}(\lambda_1, \dots, \lambda_N)$, where $\lambda_i \in \mathbb{R} : \lambda_i > 0$ for $i = 1, \dots, N$, so that we can define the change of coordinates $\bar{\xi} \triangleq (U \otimes I_{\bar{n}})\hat{\xi}$, $\bar{\mathbf{u}}_0 \triangleq (U \otimes I_h)\hat{\mathbf{u}}_0$, $\bar{\zeta} \triangleq (U \otimes I_m)\hat{\zeta}$. By applying similar calculation as in the previous sections, the global system in the new coordinates is

$$\begin{cases} \hat{\xi}^+ = \left(I_N \otimes \hat{A} + \Lambda \otimes \hat{B} \right) \hat{\xi} + \left(I_N \otimes \hat{B} \right) \hat{\mathbf{u}}_0 \\ \hat{\zeta} = \left(I_N \otimes \bar{C} \right) \hat{\xi} \end{cases} \quad (14)$$

Splitting (14) in N subsystems yields the following equation for subsystem i

$$\begin{cases} \hat{\xi}_i^+ = \begin{bmatrix} (A + B_2 D_c(\lambda_i C)) & B_2 C_c \\ B_c(\lambda_i C) & A_c \end{bmatrix} \hat{\xi}_i + \begin{bmatrix} -B_1/\chi_0 \\ 0 \end{bmatrix} \hat{u}_0 \\ \hat{\zeta}_i = C \hat{e}_i \end{cases} \quad (15)$$

where $\hat{\xi}_i \triangleq \text{col}(\hat{e}_i, \hat{x}_{c_i})$. System (15) can be equivalently described as the connection of the two following systems

$$\begin{cases} \hat{e}_i^+ = A \hat{e}_i + B_2 \hat{u}_i - B_1/\chi_0 \hat{u}_0 \\ \hat{y}_i \triangleq (\lambda_i C) \hat{e}_i \\ \hat{\zeta}_i = C \hat{e}_i \end{cases}, \quad \begin{cases} \hat{x}_{c_i}^+ = A_c \hat{x}_{c_i} + B_c \hat{y}_i \\ \hat{u}_i \triangleq C_c \hat{x}_{c_i} + D_c \hat{y}_i \end{cases} \quad (16)$$

The rest of the proof is similar to the last part of the one of Theorem 1. In particular, since system (15) can be seen as one system with uncertain parameter $\lambda_i \in [\underline{\lambda}_{\mathcal{M}}, \bar{\lambda}_{\mathcal{M}}]$, we make use of LMI conditions of Theorem 4, and we impose them to be simultaneously satisfied for two systems at the vertexes of the polytope having matrices $(A, B_2, \underline{\lambda}_{\mathcal{M}} C)$, and $(A, B_2, \bar{\lambda}_{\mathcal{M}} C)$. The proof is concluded as for Theorem 1. \square

Remark 3. A similar remark to the one of Remark 1 holds for the leader-follower consensus case too. In particular, having imposed a PID structure for the distributed controller is not sufficient to guarantee rejection of constant u_0 vectors in the MIMO case. A necessary condition though is given by $l \geq m$.

4 Wind Farm Control Problem

4.1 Wind Turbine Model

The wind turbine model describes the conversion from wind power to electric power. The wind kinetic energy captured by the turbine is turned into mechanical

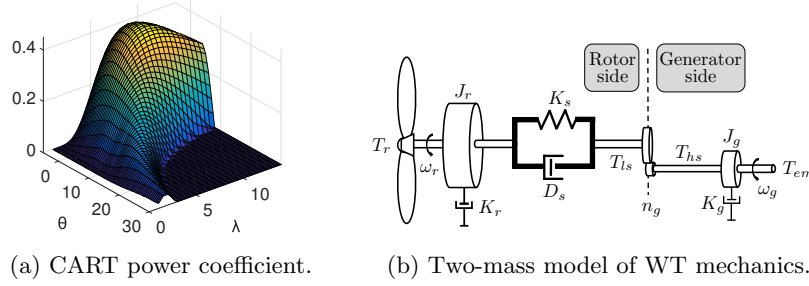

Fig. 2. Wind turbine aerodynamics and mechanics.

energy of the turbine rotor, turning at an angular speed ω_r and subject to a torque T_r . In terms of extracted power, it can be described by the nonlinear function $P_r = \omega_r T_r = 1/2 \rho \pi R^2 v^3 C_p(\lambda, \vartheta)$, where ρ is the air density, R is the radius of the rotor blades, ϑ is the pitch angle, v is the effective wind speed representing the wind field impact on the turbine, λ is the tip speed ratio given by $\lambda = \frac{\omega_r R}{v}$. C_p , nonlinear function of the tip speed ratio and pitch angle, is the power coefficient. This is typically provided in turbine specifications as a look-up table. As far as the turbine parameters are concerned, in this work we make use of the CART (Controls Advanced Research Turbine) power coefficient shown in Fig. 2a. This turbine is located at NREL's National Wind Technology Center. Nonetheless, we employ a *polynomial* approximation of the latter for the purpose of the synthesis of the controller. Referring to a two-mass model as in [25], and as shown in Fig. 2b, then, the low speed shaft torque T_{ls} acts as a braking torque on the rotor, the generator is driven by the high speed torque T_{hs} , and braked by the generator electromagnetic torque T_{em} . The drive train turns the slow rotor speed into high speed on the generator side, ω_g . Finally J_r is the rotor inertia, K_r , and K_g damping coefficients, n_g the gear ratio, and J_g the generator inertia. The dynamics of the WT is thus described by $J_r \dot{\omega}_r = T_r - K_r \omega_r - T_{ls}$, and $J_g \dot{\omega}_g = T_{hs} - K_g \omega_g - T_{em}$. In this paper we also consider a first order system to model the pitch actuator, endowed with a *sigmoid* function $\sigma : \mathbb{R} \rightarrow [\vartheta_{min}, \vartheta_{max}]$ to model the pitch saturation. In addition, for ease of further development we can bring the system equations back on the low speed side, obtaining the simplified overall model

$$\begin{cases} \tau_\vartheta \dot{\vartheta}_s = -\vartheta_s + \vartheta_r \\ \vartheta = \sigma(\vartheta_s) \\ J_t \dot{\omega}_r = \frac{P_r(\omega_r, \vartheta, v)}{\omega_r} - K_t \omega_r - T_g \end{cases} \quad (17)$$

where $T_g \triangleq n_g T_{em}$, $J_t \triangleq J_r + n_g^2 J_g$, $K_t \triangleq K_r + n_g^2 K_g$, and where we used the relation $n_g = \omega_g / \omega_r = T_{ls} / T_{hs}$. Eventually, neglecting the generator losses, the electric power delivered to the grid is $P = T_g \omega_r$. The system inputs are T_g , and ϑ_r , while the wind speed v acts as a disturbance. The feasible domain of the state variable is $X \triangleq \{(\omega_r, \vartheta) \in \mathbb{R}^2 : \omega_r \in [\omega_{r,min}, \omega_{r,max}], \vartheta \in [\vartheta_{min}, \vartheta_{max}]\}$.

4.2 Problem Statement

In the sequel, for consistency of notation, we add the index i to the WT variables described in the previous subsection when referring to turbine i variables, and we drop it when the results hold for any WT. At low wind speed, WTs are usually operated according to the well-known MPPT algorithm. The maximum power that a WT can extract from the wind is thus attained for a constant value of ϑ , named here ϑ^o , depending on the turbine C_p , and by controlling the WT to track the optimal tip speed ratio value $\lambda^o \triangleq \arg \max_{\lambda} P_r(v, \vartheta^o, \lambda) = \arg \max_{\lambda} C_p(\lambda, \vartheta^o)$. We name $C_p^o \triangleq C_p(\lambda^o, \vartheta^o)$, and $P^o(v) \triangleq P_r(v, \vartheta^o, \lambda^o)$. For the considered CART turbine $\lambda^o \cong 8$. Nonetheless, when considering the wake effect in the optimization step of a farm of N WTs, the optimal value of C_p related to the generic turbine i is such that $C_{p,i}^* \leq C_p^o$. As a matter of fact, this implies that a turbine i should track an optimal power reference $P_i^*(v_i)$ that satisfies $P_i^*(v_i) \leq P_i^o(v_i)$, i.e. it has to be *deloaded* if maximum wind farm power is seek. The reader may refer to the works of e.g. [26, 19] to see how values $C_{p,i}^*$ can be computed. According to the usually employed wake models, as well as the following

Assumption 1 For $i = 1, \dots, N$, v_i is such that $P_i^*(v_i) < P_n$, where P_n is the nominal WT power.

Then, the static optimization step needs to be run only when the wind direction changes, as optimal values $C_{p,i}^*$ do not depend on the wind speed value, [19].

Assumption 2 The average wind direction is considered to be slowly varying with respect to the system dynamics. Thus, it is considered to be constant.

We can formulate the overall WF control problem in two subproblems, the first of which being

Problem 1. Consider the system described by (17). Given an effective wind speed signal $v(t)$, and a time-varying reference trajectory $P^{ref}(t)$, verifying $P^{ref}(t) \leq P^o(t) \forall t \geq 0$, find the signals $(\vartheta_r(t), T_g(t)) \forall t \geq 0$ such that $\lim_{t \rightarrow \infty} |P^{ref}(t) - P(t)| = 0$ for every initial condition $(\omega_r(0), \vartheta(0)) \in X : P(0) \leq P^o(0)$.

Let us now assume that each local WT controller can measure, or estimate, the effective wind speed $v_{m,i}(t)$ such that $v_i(t) = v_{m,i}(t) + v_{d,i}(t) \forall t \geq 0$. Thus $v_{d,i}$ represents a nonmeasurable time varying disturbance for turbine i .

Assumption 3 We consider small zero-mean disturbances $v_{d,i}$ with respect to $v_{m,i}$, and slowly-varying with respect to the dynamics of (17).

Each WT can compute its power reference, as described in [27], from its maximum available power P_i^o , according to

$$P_i^{fw} \triangleq P_i(v_{m,i}) = \frac{C_{p,i}^*}{C_p^o} P_i^o(v_{m,i}) \quad (18)$$

which is *optimal* in nominal conditions, i.e. $P_i^*(v_i) = \frac{C_{p,i}^*}{C_p^o} P_i^o(v_i)$ when $v_{d,i} \equiv 0$.

We can additionally require the WTs to meet an optimal *relative* power sharing condition given by

$$\frac{P_i}{\chi_i} = \frac{P_k}{\chi_k} \quad i, k = 1, \dots, N \quad (19)$$

Indeed, by naming P_∞^o the maximum power that a WT could extract from the wind if there was no wake effect, from (18) we have that $P_i/C_{p,i}^* = P_i^o/C_p^o = \gamma_i P_\infty^o/C_p^o$, $i = 1, \dots, N$, thus $P_i/\gamma_i C_{p,i}^* = P_k/\gamma_k C_{p,k}^*$, $i, k = 1, \dots, N$. We name $\chi_i \triangleq \gamma_i C_{p,i}^* \in \mathbb{R}^+$, and where $\gamma_i = P_i^o/P_\infty^o = (v_i/v_\infty)^3$ are constant values for any value of v_∞ according to Assumptions 1, and 2, being v_∞ the free stream wind speed. In the sequel, in order to make the difference with condition (19) clear, we will refer to (18) as the *absolute* power reference. This is optimal if the corresponding $v_{d,i} = 0$. Despite being redundant information with respect to (18) in nominal conditions, as it will be made clear in the sequel, condition (19) provides additional signals that can be exploited when the system is subject to disturbances. We can now state the second subproblem.

Problem 2. Given N identical WTs, allowed to communicate on an undirected connected graph \mathcal{G} ; given optimal values $C_{p,i}^*$, and χ_i , $i = 1, \dots, N$; find $P_i^{ref}(t) \forall t \geq 0$, $i = \dots, N$ such that each P_i tracks (18), while minimizing the error $|P_i/\chi_i - P_j/\chi_j|$, $i, j = \dots, N$, under the presence of $v_{d,i}(t)$.

The idea behind Problem 2 is to exploit additional information concerning optimal WTs *relative* power values in order to even out the system disturbances from the optimal power sharing defined by the higher optimization step.

5 Wind Farm Control Design

5.1 Wind Turbine Control for Deloaded Mode

According to the WF optimization problem, it turns out that every WT causing a reduction of available wind power of another one, is very likely to be subject to an optimal C_p value such that $C_{p,i}^* < C_p^o$, i.e. *strictly* inferior. Thus, WTs whose $C_{p,i}^*$ verifies $C_{p,i}^* = C_p^o$ should simply perform classic MPPT regardless the disturbances of the system and the other WTs operating points, and they can be controlled with classic local controllers. In the sequel we only consider WTs that have to be *strictly* deloaded with respect to their P_i^o .

In this subsection we proposed an approximated *asymptotic output tracking* (AOT) technique to control a WT in deloaded mode, and it is based on the work of [25]. However, differently from [25], power tracking is here achieved by employing both the rotor angular speed and the pitch angle. The local WT controller is composed of a first loop to control ω_r . We impose a first order dynamics to the rotor speed tracking error $\varepsilon_\omega \triangleq \omega^{ref} - \omega_r$, i.e. $\dot{\varepsilon}_\omega + a_0 \varepsilon_\omega = 0$ by choosing $a_0 \in \mathbb{R}^+$. If we name $w \triangleq a_0 \omega^{ref} + \dot{\omega}^{ref}$, this is attained by using (17) as

$$T_{em} = T_r - (K_t - a_0 J_t) \omega_r - J_t w \quad (20)$$

We choose to regulate the power output P by acting on the pitch angle, and by imposing a first order dynamics to the electric power tracking error $\varepsilon_p \triangleq P^{ref} - P$, i.e.

$$\dot{\varepsilon}_p + b_0 \varepsilon_p = 0 \quad (21)$$

where $b_0 \in \mathbb{R}^+$. This is attained via *feedback linearization* (FL) on (17) by choosing the feedback linearizing input

$$\begin{aligned} \vartheta_r = \frac{1}{\beta(\omega_r, \vartheta_s, v)} & \left(\dot{P}^{ref} - \omega_r \frac{\partial T_r}{\partial v} \dot{v} + \frac{\omega_r}{\tau_\vartheta} \frac{\partial T_r}{\partial \vartheta} \frac{d\sigma}{d\vartheta_s} \vartheta_s + J_t \dot{w} \omega_r \right. \\ & \left. + \left(2(K_t - a_0 J_t) \omega_r - T_r + J_t w - \omega_r \frac{\partial T_r}{\partial \omega_r} \right) (-a_0 \omega_r + w) + b_0 \varepsilon_p \right) \end{aligned} \quad (22)$$

where $\frac{\partial T_r}{\partial \omega_r}$, $\frac{\partial T_r}{\partial \vartheta}$, and $\frac{\partial T_r}{\partial v}$ are functions of (ω_r, ϑ, v) , and $\beta \triangleq \frac{\omega_r}{\tau_\vartheta} \frac{d\sigma}{d\vartheta_s} \frac{\partial T_r}{\partial \vartheta}$. As pointed out in our previous work [28], there exist points in which $\beta = 0$, called *singular points*, i.e. points in which (22), feedback linearizing input with respect to output P , is not well-defined. These points are determined by the solution of $\frac{\partial C_q}{\partial \vartheta}(\lambda, \vartheta) = 0$, being $C_q \triangleq \frac{C_p}{\lambda}$, since $\beta(\omega_r, \vartheta_s, v) = \frac{\omega_r}{2\tau_\vartheta} \rho \pi R^3 v^2 \frac{d\sigma}{d\vartheta_s} \frac{\partial C_q}{\partial \vartheta}(\omega_r, \sigma(\vartheta_s), v) \cong \frac{\omega_r}{2\tau_\vartheta} \rho \pi R^3 v^2 \frac{\partial C_q}{\partial \vartheta}(\omega_r, \vartheta, v)$ in the domain of interest of ϑ , and $\omega_r, v > 0$. In Fig. 3a the white area represents $\Lambda = \{(\lambda, \vartheta) : (\omega_r, \vartheta) \in \mathcal{X} \wedge \beta < 0\}$. If ω^{ref} is chosen to let λ be in a neighborhood of λ^o , and $\vartheta > \vartheta^o$ in order to deload the WT, where $\vartheta^o \simeq 0^\circ$ for CART turbine, then it is clear that β is *negative*-valued in the points of functioning of interest. In order to ensure that the trajectories of the closed loop system, defined by (17), (20), (22), do not pass through singular points, we consider a *modified* FL function for ϑ_r , by replacing the β function appearing in (22) with

$$\begin{aligned} \hat{\beta} & \triangleq \frac{\omega_r}{2\tau_\vartheta} \rho \pi R^3 v^2 \frac{d\sigma}{d\vartheta_s} \left(\frac{\partial C_q}{\partial \vartheta}(\lambda, \vartheta) - \varepsilon(\lambda, \vartheta) \right) \\ \varepsilon(\lambda, \vartheta) & \triangleq \begin{cases} \varrho \max \left\{ \frac{\partial C_q}{\partial \vartheta}(\lambda, \vartheta), 0 \right\} & \text{if } \frac{\partial C_q}{\partial \vartheta}(\lambda, \vartheta) \neq 0 \\ \epsilon_1 & \text{otherwise} \end{cases} \end{aligned} \quad (23)$$

where ϵ_1 is a small positive value, and $\varrho > 1$ is a tunable parameter to let some margin to have $\hat{\beta}$ negative-valued in the system trajectories. Thus we obtain an expanded negative-valued area $\hat{\Lambda} = \{(\lambda, \vartheta) : (\omega_r, \vartheta) \in \mathcal{X} \wedge \hat{\beta} < 0\}$, shown in Fig. 3b. The idea is thus to perform an approximated FL *only* when the system trajectories come close to a singular point. Clearly, in this case, the chosen ϑ_r no longer guarantees satisfaction of (21). Nonetheless, under proper choice of ω^{ref} , and deloading technique, approximation (23) may occur only during transients. We can summarize the results in this subsection by stating the following

Theorem 3. *Given system (17), controlled via (20), and (22), where the β function is replaced with (23). For any initial condition $(\omega_r(0), \vartheta(0)) \in \hat{\Lambda}$, the*

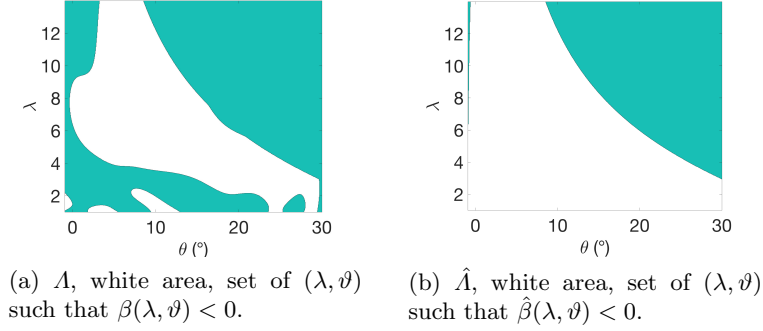

Fig. 3. Singular points with and without β approximation.

system trajectories are bounded if parameters b_0 , ϵ_1 , and ϱ are chosen such that $\epsilon_1 > 0$ is sufficiently small, $\varrho > 1$, and $b_0 > -\frac{\varrho}{1-\varrho}$. In addition, if $\exists \bar{t} \geq 0$ such that $\frac{\partial C_q}{\partial \vartheta}(\lambda(t), \vartheta(t)) < 0 \forall t \geq \bar{t}$, then $\lim_{t \rightarrow \infty} |P^{ref}(t) - P(t)| = 0$.

Proof. First of all, initial conditions in \hat{A} imply $\hat{\beta}(0) < 0$, then $\epsilon_1 > 0$, $\varrho > 1$ allow $\hat{\beta}(t) < 0 \forall t \geq 0$. In particular $\hat{\beta}(t) \neq 0 \forall t \geq 0$, thus (22) is well-defined. Note that initial conditions considered in Problem 1 satisfy $\hat{\beta}(0) < 0$, belonging to \hat{A} shown in Fig. 3b. The system dynamics in closed loop is given by

$$\dot{\epsilon}_p = \left(-b_0 + 1 - \frac{\beta}{\beta + \beta_\epsilon} \right) \epsilon_p + \left(1 - \frac{\beta}{\beta + \beta_\epsilon} \right) \varphi(\varsigma) \quad (24)$$

where we named $\beta_\epsilon \triangleq \hat{\beta} - \beta$, and $\varphi(\varsigma)$ the function composed of all the terms appearing in the right factor of (22) deprived of the term $b_0 \epsilon_p$, and being $\varsigma \triangleq (\omega_r, v, \vartheta_s, \dot{v}, w, \dot{w}, \dot{P}^{ref})$. The term $\left(1 - \frac{\beta}{\beta + \beta_\epsilon} \right) \varphi(\varsigma)$ is bounded in the trajectories thanks to the choice of β_ϵ , and being φ a continuous function on a compact set. The latter is compact because the wind is limited, w , \dot{w} , \dot{P}^{ref} are chosen to be so, ω_r is bounded thanks to (20), and term $\frac{d\sigma}{d\vartheta_s} \vartheta_s$ is bounded. Thus it will be considered as a bounded input of (24) to simplify the analysis. Finally system (24) with $\varphi(\varsigma) \equiv 0$, given by

$$\dot{\epsilon}_p = \begin{cases} \left(-b_0 + 1 - \frac{1}{\epsilon_1} \right) \epsilon_p & \text{if } \beta = 0 \\ \left(-b_0 + 1 - \frac{1}{1-\varrho} \right) \epsilon_p & \text{if } \beta > 0 \\ -b_0 \epsilon_p & \text{otherwise} \end{cases} \quad (25)$$

is stable if, for instance, we choose $b_0 > -\frac{\varrho}{1-\varrho}$, and $\epsilon_1 < 1$. This can be proved by choosing $V(\epsilon_p) \triangleq \frac{1}{2} \epsilon_p^2$ as a common Lyapunov function for the family of

systems (25), (see [29]). Eventually, if for some $\bar{t} \geq 0 : \frac{\partial C_q}{\partial \vartheta} < 0 \forall t \geq \bar{t}$, then (24) reduces to $\dot{\varepsilon}_p = -b_0 \varepsilon_p$, thus $P \rightarrow P^{ref}$ for $t \rightarrow \infty$.

Remark 4. Concerning ω^{ref} , we make the choice to use the MPPT signal $\omega_r^o = \frac{\lambda^o v}{R}$ sufficiently filtered of its high frequency components. There are different motivations to support this choice. First of all, if v varies rapidly so it does ω_r^o , then if we consider $\omega^{ref} = \omega_r^o$, its variation would directly effect ϑ_r via (22), and in turns ϑ . This fact risks to make ϑ hit the saturation constraints of the sigmoid function, and more in general, to not let the constraints on $\dot{\vartheta}$ be respected, as in this framework they are only verified *a posteriori*. Secondly, if ω^{ref} varies too rapidly, by empirical results it turns out that the closed-loop system trajectories are more likely to approach singular points, letting the activation of $\varepsilon(\lambda, \vartheta)$ defined in (23), and not allowing satisfaction of (21). On the other hand, filtering ω_r^o let (22) be defined, i.e. it fulfils the requirement of tracking the desired de-loaded power reference. The physical explanation of this fact is that for a given de-loaded P^{ref} there exist infinite pairs $(\omega_r, \vartheta) \in \mathcal{X}$ that let a WT track it, (see e.g. [30, 31]), and by filtering ω_r^o , we are simply considering another possible choice of couples (ω_r, ϑ) than the one in which $\omega_r = \omega_r^o$.

5.2 Disturbance Effect and Additional Local Control Settings

Assumption 4 Trajectories of the closed-loop system described by (17), (20), (22) verify $\frac{\partial C_q}{\partial \vartheta} < 0$.

As previously mentioned, we assume that turbine i local controller is able to measure $v_{m,i}$ such that $v_i = v_{m,i} + v_{d,i}$. The effect of $v_{d,i}$ on the closed loop dynamics can be thus approximated as

$$\dot{\varepsilon}_{p,i} = -b_0 \varepsilon_{p,i} + \mu_1(\hat{\zeta}_i)v_{d,i} + \mu_2(\hat{\zeta}_i)v_{d,i}^2 + \mu_3(\hat{\zeta}_i)\dot{v}_{d,i} \quad (26)$$

obtained via first order Taylor expansion of the functions depending on v_i , in a neighborhood of $v_{m,i}$, e.g. $T_r(v_i) \cong T_r(v_{m,i}) + \frac{\partial T_r}{\partial v}(v_{m,i})v_{d,i}$, and where $\hat{\zeta}_i \triangleq (\omega_{r,i}, \vartheta_i, v_{m,i}, \dot{v}_{m,i})$. Functions μ_1, μ_2, μ_3 are not reported here for the sake of brevity. According to Assumption 3 we neglect $\mu_3(\hat{\zeta}_i)\dot{v}_{d,i}$. Moreover, by numerical simulation, the contribution of term $\mu_2 v_{d,i}^2$ can be neglected with respect to $\mu_1 v_{d,i}$. On the compact set on which μ_1 is defined, the function satisfies $\mu_{1,min} \leq \mu_1 \leq 0$, thus in the sequel we treat μ_1 as a parametric uncertainty, and we drop its dependency on $\hat{\zeta}_i$ for ease of notation. Being interested in a discrete-time communication set-up among the WTs we shall consider system (26) discretized at sampling time T_s , given by

$$\begin{aligned} \begin{bmatrix} \xi_i(k+1) \\ P_i(k+1) \end{bmatrix} &= \begin{bmatrix} 0 & 0 \\ -1 & (1 - T_s b_0) \end{bmatrix} \begin{bmatrix} \xi_i(k) \\ P_i(k) \end{bmatrix} + \\ &\begin{bmatrix} 1 \\ (1 + T_s b_0) \end{bmatrix} P_i^{ref}(k) + \begin{bmatrix} 0 \\ \mu_1 T_s \end{bmatrix} v_{d,i}(k) \end{aligned} \quad (27)$$

where we used Euler approximation, $\dot{P}_i^{ref} \simeq \frac{(P_i^{ref}(k) - P_i^{ref}(k-1))}{T_s}$, and we named $\xi_i(k) \triangleq P_i^{ref}(k-1)$. System (27) is required to track the optimal power reference provided by the higher optimization step according to (18). For the moment, let us assume that P_i^{fw} , $i = 1, \dots, N$ are not affected by wind measurement error, i.e. $P_i^{fw}(v_i)$. Because of the presence of $v_{d,i}$ in (27), affecting the controlled WT dynamics, simply setting $P_i^{ref} = P_i^{fw}$ does not guarantee P_i to asymptotically converge to P_i^{fw} , nor the satisfaction of relationship (19), describing the optimal relative power sharing values among the WTs. Under the assumption of communicating WTs on an undirected connected graph \mathcal{G} , whose associated Laplacian matrix is \mathcal{L} , one could think to exploit the leaderless PID-like distributed protocol developed in Section 2 to reduce the effect of v_d on the weighted consensus among the WTs, by acting on P_i^{ref} . Nonetheless, as pointed out in Remark 2, still the consensus function to which the system converges depends in the disturbance signals. As a result, even if *relative* distances on power values according to (19) are respected thanks to consensus control, there is no general guarantee for the power values to reach P_i^{fw} . This is why before continuing our analysis on WF consensus control, we introduce an additional *local* PI loop to system (27) to let convergence to the absolute power value P_i^{fw} . Note that the two integral actions, namely the internal loop one controlling P_i to P_i^{fw} , and the distributed control one controlling P_i to satisfy condition (19), are not in contradiction if P_i^{fw} are measurement error free. Indeed, by naming $P^{fw} \triangleq \text{col}(P_1^{fw}, \dots, P_N^{fw})$, then by construction, $\mathcal{L}DP^{fw} = \mathbf{0}$, where recall $D \triangleq \text{diag}(\frac{1}{\chi_1}, \dots, \frac{1}{\chi_N})$, which is exactly the weighted consensus condition seek by the distributed protocol. As a consequence, in such case of perfect information on P_i^{fw} , the distributed consensus is not necessary to let condition (19) be satisfied, as it is already ensured by the internal PI. However, even in this case, consensus control can be employed to enhance closed-loop performance. The above discussion holds for the case in which the wind disturbance $v_{d,i}$ only affects the system equations as shown in (27). However, $v_{d,i}$ has also a role in the computation of P_i^{fw} , since in reality we have $P_i^{fw}(v_{m,i})$. In this case, condition $\mathcal{L}DP^{fw} = \mathbf{0}$ generally does not hold, i.e. the power references provided to the local WT controller may not let satisfaction of the optimal relative power sharing. Under these circumstances, the distributed PID does have a role in forcing weighted consensus among the WTs. Moreover, the two integral actions may come to a conflict. In the following we decide to give priority to consensus seeking by allowing the distributed control action modify the local error $P_i^{fw} - P_i$. This is achieved by considering the dashed arrow shown in the control scheme of Fig. 4, where the overall WT control is illustrated. The idea behind this choice is that zero-mean disturbances on the local power references P_i^{fw} can be globally evened out by enforcing relative power distances among the network of wind turbines.

By naming K_I^l , and K_P^l respectively the integral, and proportional gains of the PI, we can write (27) in closed-loop as $x_i(k+1) = Ax_i(k) + B_2u_i(k) +$

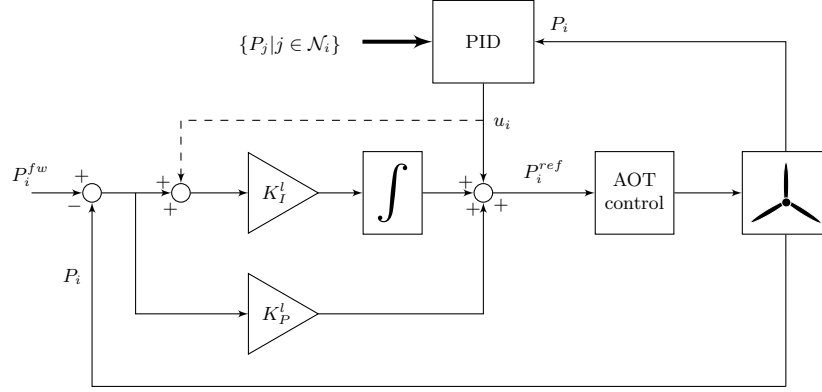

Fig. 4. WT control scheme: the local control is composed of an AOT step and of a PI; the distributed control has a PID structure. Each WT i receives P values from its neighbors, i.e. WTs $j \in \mathcal{N}_i$.

$B_{fw}P_i^{fw}(k) + B_w v_{d,i}(k)$, where

$$\begin{aligned}
 A &\triangleq \begin{bmatrix} 1 & 0 & -K_I^l T_s \\ 1 & 0 & -K_P^l \\ (1 + T_s b_0) & -1 & (1 - T_s b_0 - K_P^l (1 + T_s b_0)) \end{bmatrix}, B_w \triangleq \begin{bmatrix} 0 \\ 0 \\ \mu_1 T_s \end{bmatrix} \\
 B_2 &\triangleq \begin{bmatrix} K_I^l T_s \\ 1 \\ (1 + T_s b_0) \end{bmatrix}, B_{fw} \triangleq \begin{bmatrix} K_I^l T_s \\ K_P^l \\ (1 + T_s b_0) K_P^l \end{bmatrix}
 \end{aligned} \tag{28}$$

and where we named $x_i \triangleq \text{col}(\delta_i, \xi_i, P_i)$, being δ_i the state of the local integral action, P_i^{fw} a forward signal, and u_i is left as a degree of freedom to let distributed control. Note that other choices for the introduction of u_i in the internal WT control loop would have been possible.

5.3 Wind Farm Distributed Protocols

Leaderless Consensus As previously mentioned, consensus control over the WF can be employed to let satisfaction of relationship (19) over a set of N controlled WTs of the form of (28). This can be done by making use of the tools concerning leaderless consensus shown in Section 2. This is simply obtained by choosing as A, B_2 the matrices of (28), $C = [0 \ 0 \ 1]$, i.e. P_i is the measured and controlled output, and $B_1 = [B_{fw} \ B_w]$, i.e. P_i^{fw} , and $v_{d,i}$ are both considered as disturbances with respect to the weighted consensus.

Remark 5. The considered control approach relies on Assumption 3. In particular disturbances $v_{d,i}$ are supposed to be *zero-mean* signals. If there exist WTs for which $v_{d,i}$ has not zero mean, then the corresponding absolute power reference

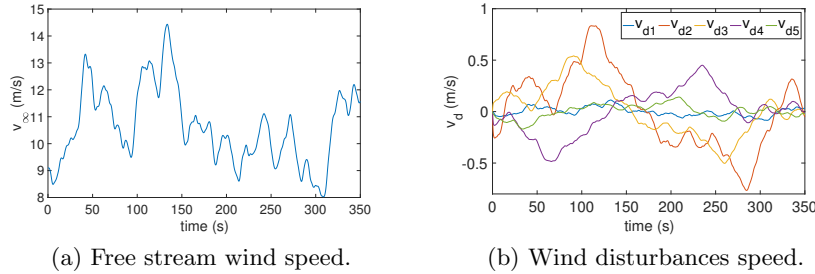

Fig. 5. Wind signals.

P_i^{fw} would be in average different from the optimal one. Unfortunately under these circumstances, there is no hope for the optimal *absolute* power sharing to be satisfied by the only means of consensus control, even if optimal *relative* power sharing condition (19) is satisfied. This is due to the fact that in a network of agents communicating on an *undirected* graph, each of them has a role in determining the consensus function to which they converge. Thus, WTs affected by nonzero-mean wind disturbance would make the whole network deviate from the optimal absolute power values in average.

Leader-follower Consensus Since leaderless consensus technique fails to restore optimal absolute power references when some WTs in the wind farm are subject to nonzero-mean wind measurement errors, if the WTs being affected by nonzero-mean wind disturbances can be detected and isolated then, for instance, the leader-follower techniques developed in Section 3 can be employed to restore the optimal power references in the concerned WTs. This could be achieved by letting the faulty WTs be *follower* agents, and the unfaulty WT network serve as a *leader*.

If, for the sake of simplicity, we consider only one WT not to be affected by absolute power reference error, and we thus let it be the only leader in the WF, then Theorem 2 can be applied by choosing A , B_2 the matrices of (28), $C = [0 \ 0 \ 1]$, and $B_1 = B_{fw}$. In addition to what shown in the leader-follower development of Section 3, in this case either the followers and the leader are additionally subject to disturbances via matrix $[B_{fw} \ B_w]$, i.e. P_i^{fw} , and $v_{d,i}$ are both considered as disturbances with respect to the weighted consensus.

6 Simulation

In the following we propose some numerical simulations to show the overall WF control performance in both leaderless and leader-follower modes. In the considered simulation test, the system is subject to two sources of model-plant mismatches. The first one is caused by differences between the polynomial C_p approximation used for the AOT-based controller design and the CART power

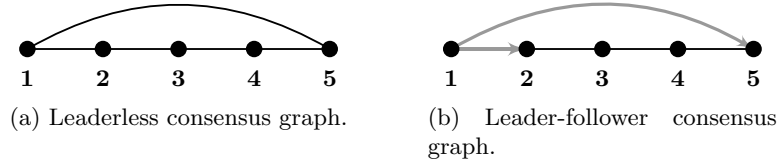

Fig. 6. WF example communication graph.

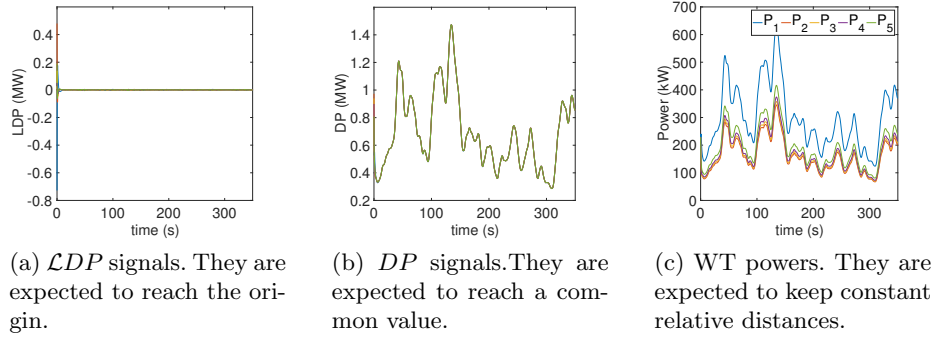

Fig. 7. Wind farm leaderless control.

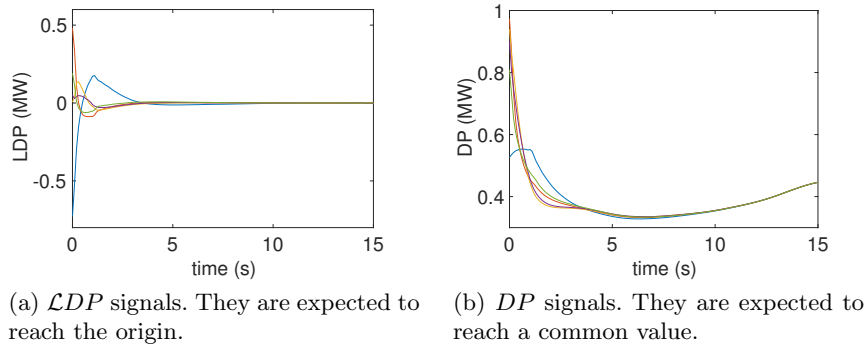

Fig. 8. Zoom on \mathcal{LDP} and DP during WF leaderless control.

coefficient given as a lookup table, and shown in Fig. 2a. The second one is given by the way $v_{d,i}$ acts on WT i . Indeed, each $v_{d,i}$ affects the according WT i dynamics via the mechanical power P_r . This causes an additional mismatch as recall that $v_{d,i}$ effect was approximated in Subsection 5.2, leading to the approximated model of system (27). We consider a WF composed of $N = 6$ WTs aligned one after the other according to the wind direction. We suppose the 6-th WT to be the last one of the row according to the wind direction. Thus

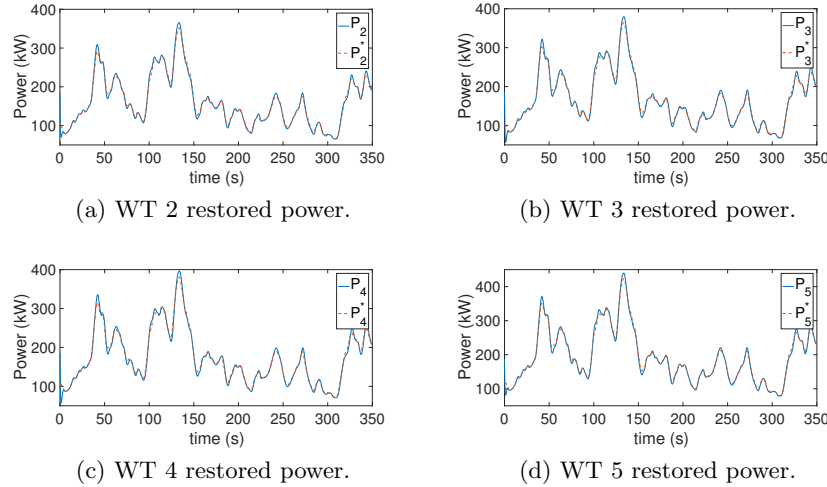

Fig. 9. Wind farm leader-follower control.

it is required to always operate in classic MPPT mode. In the following tests, it is supposed to not intervene in the consensus control, and its power signals will not be reported. Concerning leaderless control, the remaining WTs are supposed to communicate on the undirected graph shown in Fig. 6a. The free stream wind speed v_∞ blowing in front of WT 1 is chosen to have the profile of Fig. 5a. The other wind speed signals v_i , $i = 2, \dots, 5$ are obtained from v_∞ according to the wake model, (e.g. see [19]). The local WT PI gains are set equal to $K_P^l = 0.2$, and $K_I^l = 0.8$, while the PID gains for the aforementioned multi-agent system found via Theorem 1 are $K_p = 0.0072$, $K_i = -0.0638$, $K_d = 0.0013$, and they allow weighted consensus achievement with performance index $\tau = 24.5$. The disturbance $v_d \triangleq \text{col}(d_{,1}, \dots, d_{,5})$ affecting the system is chosen to be the one shown in Fig. 5b. In this case P^{fw} is computed on the available measurements $v_{m,i}$. Thus, they are corrupted by measurement error, and they do not respect the optimal relative power sharing condition (19). For this simulation we show signals \mathcal{LDP} , DP , and P , where $P \triangleq \text{col}(P_1, \dots, P_5)$. Indeed consensus is reached when $\mathcal{LDP} = \mathbf{0}$, which can be alternatively seen as weighted power signals DP reaching a common value, or as power signals P reaching defined constant relative distances. These are illustrated in Fig. 7, from which we can also notice that the aforesaid model-plant mismatches, as well as temporary dissatisfaction of Assumption 4, cause persistent small oscillations around the reached weighted consensus. For the sake of clarity, \mathcal{LDP} , and DP are also shown in a zoomed window in Fig. 8.

Eventually, we aim at showing how optimal absolute power references P_i^* can be restored via leader-follower consensus when some WTs in the WF are affected by power reference error. In order to do, we consider a simple example in which the only first WT in the row is error-free, and thus acts as the leader. In such

case, we consider the WF communication graph to be modified according to Fig. 6b, where the leader, WT 1, can communicate with WT 2 and WT 5 directly. The remaining WTs from 2 to 5 are followers and they can communicate on an undirected connected graph. We suppose the leader $v_{d,1}$ to be equal to the one shown in Fig. 5b, whereas the followers wind disturbances are *nonzero*-mean signals of the form of $v_{d,i} = \bar{v}_{d,i} + \tilde{v}_{d,i}$, where $\tilde{v}_{d,i}$ is a zero-mean signal, and $\bar{v}_{d,i}$ a constant nonzero value. $\tilde{v}_{d,i}$, $i = 2, \dots, 5$ are supposed to be equal to the corresponding i -th signal in Fig. 5b used in the previous simulation, while $\bar{v}_{d,i}$ are such that $P_2^{fw} = 80\%P_2^*$, $P_3^{fw} = 60\%P_3^*$, $P_4^{fw} = 30\%P_4^*$, $P_5^{fw} = 40\%P_5^*$, i.e. without leader-follower control they would track a not optimal power reference. By employing fast leader-follower weighted consensus technique, the PID gains are $K_p = 0.0082$, $K_i = -0.0656$, and $K_d = -0.0028$, and they allow a performance index equal to $\tau = 24.5$. Simulation results are illustrated in Fig. 9, where the red dashed signals represent the original optimal power reference P_i^* , and the blue solid line the obtained power output via consensus control. We are able to conclude that consensus control shows good performance in restoring the optimal absolute power values. Small persistent errors are due to model-plant mismatches, by the fact that the PID structure cannot reject general time-varying reference state, and because wind disturbance $\tilde{v}_{d,i}$ also affect the system consensus function.

7 Conclusion

We presented a PID-like distributed protocol for general LTI MIMO discrete-time agents. By employing LMIs we showed how the controller gains can be tuned to solve two different, yet similar, problems, namely a leaderless under system disturbances and a leader-follower under time-varying reference state weighted consensus problem. The distributed control approaches were then applied to treat some issues concerning the wind farm power maximization problem under wake effect. In order to do so, first an approximated AOT control technique allows a WT to track a general deloaded power reference by acting on both the rotor speed and the pitch angle. Leaderless control technique was then used to average out zero-mean wind disturbances from the optimal WF power sharing, while we showed how leader-follower control can be applied to restore the optimal power sharing in the case of power reference errors.

In the near future it would be interesting to consider other LMI approaches, such as \mathcal{H}_∞ loop-shaping, to tune a distributed controller that could take into account prior knowledge about system disturbances for a better rejection on consensus reaching. Concerning the wind farm control problem, consensus control represents a fairly new approach, and it may lead to a great variety of other applications, such as the distributed estimation of the wind field within a wind farm.

Acknowledgment This study has been carried out in the RISEGrid Institute (www.supelec.fr/342p38091/risegrid-en.html), joint program between Centrale-Supelec and EDF ('Electricité de France') on smarter electric grids.

Appendix

Appendix 1

A directed graph \mathcal{G} , called *digraph*, is a pair $(\mathcal{V}, \mathcal{E})$, where $\mathcal{V} = \{1, \dots, N\}$ is the set of nodes, and $\mathcal{E} \subseteq \mathcal{V} \times \mathcal{V}$ is the set of unordered pairs of nodes, named edges. Two nodes i, j are said to be adjacent if $(i, j) \in \mathcal{E}$. In such case the communication is supposed to be directed from i to j . We additionally define \mathcal{N}_i to be the set of neighbors of node i , i.e. $\mathcal{N}_i \triangleq \{j \in \mathcal{V} : (j, i) \in \mathcal{E}\}$. The *weighted* adjacency matrix $\mathcal{A} = [a_{ij}] \in \mathbb{R}^{N \times N}$ associated with the digraph \mathcal{G} , is defined by $a_{ii} = 0$, i.e. self-loops are not allowed, and $a_{ij} > 0$ if $(i, j) \in \mathcal{E}$. The Laplacian matrix $\mathcal{L} = [l_{ij}] \in \mathbb{R}^{N \times N}$ is defined as $l_{ii} = \sum_{j \neq i} a_{ij}$ and $l_{ij} = -a_{ij}$, $i \neq j$. Typically, if the adjacency matrix is not weighted, then we simply assign $a_{ij} = 1$ if $(i, j) \in \mathcal{E}$. Moreover, under the assumption of *undirected* graph, $(i, j) \in \mathcal{E}$ implies that $(j, i) \in \mathcal{E}$ too. In this report an undirected graph is always considered to be not weighted. An undirected graph is connected if there exists a path between every pair of distinct nodes, otherwise it is disconnected. If there exist an edge between any two nodes, the graph is said to be complete. We provide the following useful lemmas.

Lemma 1. [32] *The Laplacian matrix has the following properties: (i) if \mathcal{A} refers to an undirected graph, then \mathcal{L} is symmetric and all its eigenvalues are either strictly positive or equal to 0, and $\mathbf{1}$ is the corresponding eigenvector to 0; (ii) 0 is a simple eigenvalue of \mathcal{L} if and only if the graph is connected.*

Lemma 2. [33] *Let $\bar{\mathcal{L}} = [\bar{l}_{ij}] \in \mathbb{R}^{N \times N}$ be a Laplacian matrix such that $\bar{l}_{ij} = N^{-1/N}$ if $i = j$, and $\bar{l}_{ij} = -1/N$ otherwise, then the following hold: (i) the eigenvalues of $\bar{\mathcal{L}}$ are 1 with multiplicity $N - 1$, and 0 with multiplicity 1. $\mathbf{1}^\top$ and $\mathbf{1}$ are respectively the left and right eigenvector associated to eigenvalue 0; (ii) there exists an orthogonal matrix $U \in \mathbb{R}^{N \times N}$, i.e. $U : U^\top U = U U^\top = I$, and whose last column is equal to $\mathbf{1}/\sqrt{N}$, such that for any Laplacian matrix \mathcal{L} associated to any undirected graph we have*

$$U^\top \bar{\mathcal{L}} U = \begin{bmatrix} I_{N-1} & 0_{(N-1) \times 1} \\ 0_{1 \times (N-1)} & 0 \end{bmatrix} \triangleq \bar{\mathcal{A}},$$

$$U^\top \mathcal{L} U = \begin{bmatrix} \mathcal{L}_1 & 0_{(N-1) \times 1} \\ 0_{1 \times (N-1)} & 0 \end{bmatrix}$$

where $\mathcal{L}_1 \in \mathbb{R}^{(N-1) \times (N-1)}$ is symmetric and positive definite if the graph is connected.

Moreover we deduce the following extension of Lemma 2.

Lemma 3. *Let $\mathcal{L} \in \mathbb{R}^{N \times N}$ be the Laplacian matrix associated to an undirected connected graph, and let $D \in \mathbb{R}^{N \times N} \succ 0$, and symmetric, then the following hold: (i) $\hat{\mathcal{L}} \triangleq D \mathcal{L} \succeq 0$, all its eigenvalues are real, and 0 is a simple eigenvalue*

with associated eigenvector $\mathbf{1}$; (ii) consider the orthogonal matrix $U \in \mathbb{R}^{N \times N}$ defined in Lemma 2, then

$$U^\top \hat{\mathcal{L}}U = \begin{bmatrix} \hat{\mathcal{L}}_1 & 0_{(N-1) \times 1} \\ * & 0 \end{bmatrix}$$

where $*$ indicates a generally nonempty row, $\hat{\mathcal{L}}_1 \in \mathbb{R}^{(N-1) \times (N-1)} \succ 0$, and its eigenvalues are real.

Proof. We have that $D\mathcal{L} = D^{1/2}(D^{1/2}\mathcal{L}D^{1/2})D^{-1/2}$, thus $D\mathcal{L}$ is similar to a symmetric semi-definite positive matrix, so its eigenvalues are positive real. $\hat{\mathcal{L}}$ preserves the 0 eigenvalue, and its associated eigenvector $\mathbf{1}$, as $D\mathcal{L}\mathbf{1} = \mathbf{0}$. 0 is a simple eigenvalue as D is nonsingular, and \mathcal{L} has one simple 0 eigenvalue by hypothesis. The last column of $U^\top \hat{\mathcal{L}}U$ has all its entries equal to 0 because the last column of U is $\mathbf{1}/\sqrt{N}$. Being $U^\top \hat{\mathcal{L}}U$ block triangular, and similar to $\hat{\mathcal{L}}$, $\hat{\mathcal{L}}_1$ has all real strictly positive eigenvalues. \square

Lemma 4. *Given two symmetric matrices A , and B of equal dimension such that $A \succeq 0$, and $B \succ 0$; then $\sigma(AB) \subset \mathbb{C}_{\geq 0}$.*

Proof. It exists the symmetric matrix $B^{1/2} : B^{1/2}B^{1/2} = B$, where $B^{1/2} \succ 0$, and it exists $B^{-1/2} : B^{-1/2}B^{1/2} = B^{1/2}B^{-1/2} = I$. We have that $AB = AB^{1/2}B^{1/2} = B^{-1/2}(B^{1/2}AB^{1/2})B^{1/2}$, thus $\sigma(AB) \equiv \sigma(B^{1/2}AB^{1/2})$. Moreover $B^{1/2}AB^{1/2} \succeq 0$ because $A \succeq 0$ and $B^{1/2}$ is symmetric. Thus $\sigma(B^{1/2}AB^{1/2}) \subset \mathbb{C}_{\geq 0}$. \square

Lemma 5. *Given two symmetric matrices A , and B of equal dimension; if $A \succ 0$ then AB is diagonalizable in \mathbb{R} .*

Proof. It exists the symmetric matrix $A^{1/2} : A^{1/2}A^{1/2} = A$, where $A^{1/2} \succ 0$, and it exists $A^{-1/2} : A^{-1/2}A^{1/2} = A^{1/2}A^{-1/2} = I$. We have $A^{-1/2}ABA^{1/2} = A^{1/2}BA^{1/2}$, and the latter is symmetric. Thus AB is similar to a symmetric matrix, so it is diagonalizable in \mathbb{R} . \square

We recall the following lemma on *Kronecker product* \otimes

Lemma 6. [34] *Suppose that $U \in \mathbb{R}^{p \times p}$, $V \in \mathbb{R}^{q \times q}$, $X \in \mathbb{R}^{p \times p}$, and $Y \in \mathbb{R}^{q \times q}$. The following hold: (i) $(U \otimes V)(X \otimes Y) = UX \otimes VY$; (ii) suppose U , and V invertible, then $(U \otimes V)^{-1} = U^{-1} \otimes V^{-1}$.*

Appendix 2

In the following we report the cited theorem of [24]. Consider the system of equations

$$\begin{cases} x^+ = Ax + Bu \\ y = Cx \end{cases} \quad (29)$$

where $A \in \mathbb{R}^{n \times n}$, $B \in \mathbb{R}^{n \times l}$, $C \in \mathbb{R}^{m \times n}$, $x \triangleq x(k) \in \mathbb{R}^n$ and $x^+ \triangleq x(k+1) \in \mathbb{R}^n$ are respectively the system state at the current step k , and at the next step $k+1$,

$u \triangleq u(k) \in \mathbb{R}^l$ is the control input, and $y \triangleq y(k) \in \mathbb{R}^m$ is the measured and controlled output. Define the matrices $C_{cl} \triangleq [C \ 0_{r \times (2l)}]$, $K \triangleq [D_c^\top \ B_c^\top]^\top$, and

$$\tilde{A} \triangleq \begin{bmatrix} A & BC_c \\ 0_{2l \times n} & A_c \end{bmatrix}$$

where A_c , B_c , C_c , and D_c are defined in (3). Assuming B to be of full column rank without loss of generality, there exists an invertible $T_b \in \mathbb{R}^{n \times n} : T_b B = [0_{l \times (n-l)} \ I_{l \times l}]^\top$. Finally define

$$T \triangleq \begin{bmatrix} T_b & 0_{n \times 2l} \\ 0_{2l \times n} & I_{2l \times 2l} \end{bmatrix}$$

Thus, we have the following theorem

Theorem 4. *Consider system (29). If there exists a positive definite matrix $P \in \mathbb{R}^{\bar{n} \times \bar{n}}$, and a matrix*

$$J = \begin{bmatrix} J_{11} & 0_{(\bar{n}-q) \times 3l} \\ J_{21} & J_{22} \end{bmatrix}$$

$J_{22} \in \mathbb{R}^{3l \times 3l}$, and $X \in \mathbb{R}^{3l \times m}$, and we further name

$$\Omega \triangleq \begin{bmatrix} 0_{(\bar{n}-3l) \times n} & 0_{(\bar{n}-3l) \times 2l} \\ XC & 0_{3l \times 2l} \end{bmatrix}$$

such that the following LMI has a solution

$$\begin{bmatrix} bP & * \\ \Omega + JT\tilde{A} + aJT & b(JT + (JT)^\top - P) \end{bmatrix} > 0$$

where $*$ indicates the transposed of the opposite term with respect to the matrix diagonal, and if J is nonsingular, then by choosing $K = J_{22}^{-1}X$, the eigenvalues of the following matrix

$$A_{cl} \triangleq \begin{bmatrix} (A + BD_cC) & B_2C_c \\ B_cC & A_c \end{bmatrix}$$

lie in the region $\mathcal{F}_D \triangleq \{(\Re[\lambda], \Im[\lambda]) : (\Re[\lambda] + a)^2 + \Im[\lambda]^2 < b^2\}$.

References

1. Ren, W., Beard, R.W.: Distributed consensus in multi-vehicle cooperative control. Springer (2008)
2. Xi, J., Cai, N., Zhong, Y.: Consensus problems for high-order linear time-invariant swarm systems. Physica A: Statistical Mechanics and its Applications 389(24), 5619–5627 (2010)
3. Li, Z., Ren, W., Liu, X., Fu, M.: Distributed containment control of multi-agent systems with general linear dynamics in the presence of multiple leaders. International Journal of Robust and Nonlinear Control 23(5), 534–547 (2013)

4. Yang-Zhou, C., Yan-Rong, G., ZHANG, Y.X.: Partial stability approach to consensus problem of linear multi-agent systems. *Acta Automatica Sinica* 40(11), 2573–2584 (2014)
5. You, K., Xie, L.: Network topology and communication data rate for consensusability of discrete-time multi-agent systems. *IEEE Transactions on Automatic Control* 56(10), 2262–2275 (2011)
6. Su, Y., Huang, J.: Two consensus problems for discrete-time multi-agent systems with switching network topology. *Automatica* 48(9), 1988–1997 (2012)
7. Ge, Y., Chen, Y., Zhang, Y., He, Z.: State consensus analysis and design for high-order discrete-time linear multiagent systems. *Mathematical Problems in Engineering* 2013 (2013)
8. Li, Z., Duan, Z., Xie, L., Liu, X.: Distributed robust control of linear multi-agent systems with parameter uncertainties. *International Journal of Control* 85(8), 1039–1050 (2012)
9. Oh, K.K., Moore, K.L., Ahn, H.S.: Disturbance attenuation in a consensus network of identical linear systems: An approach. *IEEE Transactions on Automatic Control* 59(8), 2164–2169 (2014)
10. Li, Z., Duan, Z., Chen, G.: On h_∞ and h_2 performance regions of multi-agent systems. *Automatica* 47(4), 797–803 (2011)
11. Wang, L., Gao, L.: H_∞ consensus control for discrete-time multi-agent systems with switching topology. *Procedia Engineering* 15, 601 – 607 (2011)
12. Xi, J., Shi, Z., Zhong, Y.: Output consensus analysis and design for high-order linear swarm systems: partial stability method. *Automatica* 48(9), 2335–2343 (2012)
13. Liu, Y., Jia, Y., Du, J., Yuan, S.: Dynamic output feedback control for consensus of multi-agent systems: an h_∞ approach. In: 2009 American Control Conference. pp. 4470–4475. IEEE (2009)
14. Carli, R., Chiuso, A., Schenato, L., Zampieri, S.: A pi consensus controller for networked clocks synchronization. *IFAC Proceedings Volumes* 41(2), 10289–10294 (2008)
15. Ou, L.L., Chen, J.J., Zhang, D.M., Zhang, L., Zhang, W.D.: Distributed h_∞ pid feedback for improving consensus performance of arbitrary-delayed multi-agent system. *International Journal of Automation and Computing* 11(2), 189–196 (2014)
16. Ren, W.: Multi-vehicle consensus with a time-varying reference state. *Systems & Control Letters* 56(7), 474–483 (2007)
17. Cao, Y., Ren, W., Li, Y.: Distributed discrete-time coordinated tracking with a time-varying reference state and limited communication. *Automatica* 45(5), 1299–1305 (2009)
18. Gionfra, N., Sandou, G., Siguerdidjane, H., Faille, D.: A distributed pid-like consensus control for discrete-time multi-agent systems. In: ICINCO, 14th International Conference on Informatics in Control, Automation and Robotics (2017)
19. Park, J., Law, K.H.: Cooperative wind turbine control for maximizing wind farm power using sequential convex programming. *Energy Conversion and Management* 101, 295–316 (2015)
20. Zhang, W., Xu, Y., Liu, W., Ferrese, F., Liu, L.: Fully distributed coordination of multiple dfigs in a microgrid for load sharing. *IEEE Transactions on Smart Grid* 4(2), 806–815 (2013)
21. Biegel, B., Madjidian, D., Spudic, V., Rantzer, A., Stoustrup, J.: Distributed low-complexity controller for wind power plant in derated operation. In: Control Applications (CCA), 2013 IEEE International Conference on. pp. 146–151. IEEE (2013)
22. Baros, S., Ilic, M.D.: Distributed torque control of deloaded wind dfigs for wind farm power output regulation. *IEEE Transactions on Power Systems* (99) (2017)

23. Gionfra, N., Sandou, G., Siguerdidjane, H., Faille, D., Philippe, L.: A distributed consensus control under disturbances for wind farm power maximization. In: Decision and Control (CDC), 2017 IEEE 56th Annual Conference on. IEEE (2017)
24. Wu, Z., Iqbal, A., Amara, F.B.: Lmi-based multivariable pid controller design and its application to the control of the surface shape of magnetic fluid deformable mirrors. *IEEE Transactions on Control Systems Technology* 19(4), 717–729 (2011)
25. Boukhezzar, B., Siguerdidjane, H.: Nonlinear control of variable speed wind turbines for power regulation. In: Control Applications, 2005. CCA 2005. Proceedings of 2005 IEEE Conference on. pp. 114–119. IEEE (2005)
26. Gebraad, P.M., van Dam, F.C., van Wingerden, J.W.: A model-free distributed approach for wind plant control. In: American Control Conference (ACC), 2013. pp. 628–633. IEEE (2013)
27. Gionfra, N., Siguerdidjane, H., Sandou, G., Faille, D.: Hierarchical control of a wind farm for wake interaction minimization. *IFAC-PapersOnLine* 49(27), 330–335 (2016)
28. Gionfra, N., Siguerdidjane, H., Sandou, G., Faille, D., Loevenbruck, P.: Combined feedback linearization and mpc for wind turbine power tracking. In: Control Applications (CCA), 2016 IEEE Conference on. pp. 52–57. IEEE (2016)
29. Liberzon, D.: Switching in systems and control. Springer Science & Business Media (2012)
30. Yingcheng, X., Nengling, T.: Review of contribution to frequency control through variable speed wind turbine. *Renewable Energy* 36(6), 1671–1677 (2011)
31. Žertek, A., Verbič, G., Pantoš, M.: Optimised control approach for frequency-control contribution of variable speed wind turbines. *IET Renewable power generation* 6(1), 17–23 (2012)
32. Ren, W., Beard, R.W., et al.: Consensus seeking in multiagent systems under dynamically changing interaction topologies. *IEEE Transactions on automatic control* 50(5), 655–661 (2005)
33. Lin, P., Jia, Y., Du, J., Yu, F.: Distributed leadless coordination for networks of second-order agents with time-delay on switching topology. In: 2008 American Control Conference. pp. 1564–1569. IEEE (2008)
34. Graham, A.: Kronecker products and matrix calculus with applications. Holsted Press, New York (1981)