



HAL
open science

A Steer-by-Wire Control Architecture Robust to High Assistance Gains and Large Transmission Delays

Ali Diab, William Pasillas-Lépine, Giorgio Valmorbida

► **To cite this version:**

Ali Diab, William Pasillas-Lépine, Giorgio Valmorbida. A Steer-by-Wire Control Architecture Robust to High Assistance Gains and Large Transmission Delays. The 15th International Symposium on Advanced Vehicle Control, Sep 2022, Kanagawa, Japan. hal-03798214

HAL Id: hal-03798214

<https://centralesupelec.hal.science/hal-03798214>

Submitted on 5 Oct 2022

HAL is a multi-disciplinary open access archive for the deposit and dissemination of scientific research documents, whether they are published or not. The documents may come from teaching and research institutions in France or abroad, or from public or private research centers.

L'archive ouverte pluridisciplinaire **HAL**, est destinée au dépôt et à la diffusion de documents scientifiques de niveau recherche, publiés ou non, émanant des établissements d'enseignement et de recherche français ou étrangers, des laboratoires publics ou privés.

A Steer-by-Wire Control Architecture Robust to High Assistance Gains and Large Transmission Delays

Ali Diab^{†‡}, William Pasillas-Lépine[†], and Giorgio Valmorbida^{†‡}

[†] Université Paris-Saclay, CNRS, CentraleSupélec, Laboratoire des signaux et systèmes, 91190, Gif-sur-Yvette, France

[‡] Projet Team DISCO, Inria, Paris, France
E-mail: ali.diab@centralesupelec.fr

This paper proposes a robust steer-by-wire (SBW) control architecture to provide high assistance gains in the presence of internal and transmission delays. The proposed controller is inspired by Smith’s predictor to compensate for the internal delays. The controlled system is compared to the conventional proportional-derivative (PD) telemanipulation controller and is associated with a method for estimating its delay margin. Our methodology is based on frequency-domain techniques for stability analysis of time-delay systems, which provide the allowable bound on the communication delay for the system. Simulations that compare the proposed controller to a conventional PD controller are also included.

Topics / Steering, Brake, Tire, Suspension; Advanced Driver Assistance Systems; Steer-by-Wire.

1. INTRODUCTION

By-wire technologies offer flexible architectures for vehicle systems. Among the features of steer-by-wire (SBW) systems we may cite the steering column removal [1] and the possibility of teleoperation [2]. They also allow more flexibility to accommodate performance requirements, in terms of driving characteristics, than the conventional automotive steering architectures [3].

Replacing the physical link between the steering wheel and the pinion/rack decouples the steering system into two subsystems, which are connected through actuators, sensors, a control unit, and a communication network. It is therefore crucial to study the stability margins of the resulting interconnected system, where the communication between the two subsystems are subject to network delays. Moreover, both the steering wheel and the pinion subsystems are subject to internal delays, induced by the acquisition and processing of encoder events. The study of this problem is similar to the questions addressed in robotics in the context of bilateral teleoperation [4], where proportional-derivative (PD) controllers are widely used. A major challenge to preserve stability in the presence of these delays is the use of high feedback-loop gains, which are required to reduce steering effort.

In this paper, inspired by [5] and [6], a modified Smith predictor [7] is proposed to compensate for the internal delays in the presence of disturbance signals. These internal delays are usually smaller than the transmission delays and are assumed to be known and constant. Hence, their compensation allows to remove them from both local feedback loops, and the

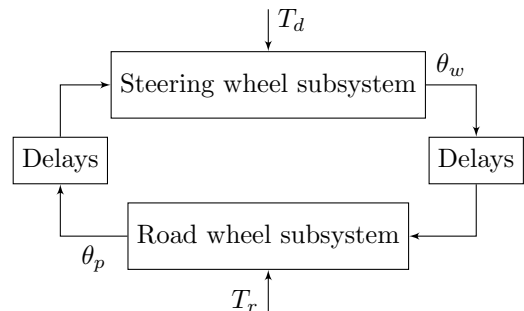

Fig. 1: SBW block diagram.

stability margin of the interconnected system is reduced to a robustness analysis with respect to the communication delays only. To that aim, a Padé approximation is used to compute an analytical expression of the delay margin of the SBW feedback loop. Finally, the delay robustness analysis presented also applies to remote vehicle operation, where the delays can be even larger than in the local vehicle network.

2. STEER-BY-WIRE MODEL

Consider the dynamics of the SBW system

$$\begin{aligned} J_w \ddot{\theta}_w(t) + \sigma_w \dot{\theta}_w(t) &= T_w(t) + T_d(t), \\ J_p \ddot{\theta}_p(t) + \sigma_p \dot{\theta}_p(t) &= T_p(t) + T_r(t), \end{aligned} \quad (1)$$

where θ_w , θ_p are the angular positions, J_w , J_p , the moments of inertia, σ_w , σ_p , the damping coefficients, and T_d , T_r , the torques generated by the driver and the road. For the PD controller, the control inputs

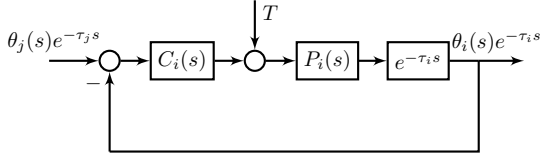

Fig. 2: Steering wheel/Road wheel subsystems block diagram with PD controller.

T_w and T_p interconnect the system with the control law

$$\begin{aligned} T_w(t) &= k_w(\theta_p(t - \tau_2 - \tau_p) - \theta_w(t - \tau_w)) \\ &\quad + \rho_w(\dot{\theta}_p(t - \tau_2 - \tau_p) - \dot{\theta}_w(t - \tau_w)), \\ T_p(t) &= k_p(\theta_w(t - \tau_1 - \tau_w) - \theta_p(t - \tau_p)) \\ &\quad + \rho_p(\dot{\theta}_w(t - \tau_1 - \tau_w) - \dot{\theta}_p(t - \tau_p)), \end{aligned} \quad (2)$$

where $k_w, k_p, \rho_w, \rho_p \in \mathbb{R}^+$ are the control law parameters, τ_w, τ_p are the internal delays, and τ_1, τ_2 are the transmission delays (see, *e.g.*, [2]). This interconnected system (1)-(2) is represented in Fig. 1, with the steering wheel and the road wheel subsystems as shown in Fig. 2, $(i, j, T) \in \{(w, p, T_d), (p, w, T_r)\}$, where the transfer function P_i and C_i , for $i = w, p$, are expressed in the Laplace domain as

$$P_i(s) = \frac{1}{J_i s^2 + \sigma_i s}$$

and

$$C_i(s) = k_i + \rho_i s.$$

Inspired by [5] and [6], to eliminate the internal delays from the feedback loop of the closed-loop subsystems, we replace the PD control law (2) by the modified Smith predictor control architecture depicted in Fig. 3, where the internal delays and the system parameters are assumed known. To improve the control architecture proposed in [5], we add to the PD controllers C_w and C_p two lead filters given, respectively, by $1 + \tau_w s$ and $1 + \tau_p s$.

Using the proposed control architecture, the transfer function from $\theta_j(s)e^{-\tau_j s}$ to $\theta_i(s)e^{-\tau_i s}$, is given by

$$\frac{\theta_i(s)e^{-\tau_i s}}{\theta_j(s)e^{-\tau_j s}} = \frac{(1 + \tau_i s)C_i(s)P_i(s)e^{-\tau_i s}}{1 + C_i(s)P_i(s)}, \quad (3)$$

and the transfer function from $T(s)$ to $\theta_i(s)$ is given by

$$\frac{\theta_i(s)}{T(s)} = \frac{P_i(s)(1 + C_i(s)P_i(s)(1 - (1 + \tau_i s)e^{-\tau_i s}))}{1 + C_i(s)P_i(s)}. \quad (4)$$

Therefore, (3) and (4) imply that the block diagrams of Fig. 3 and Fig. 4 are equivalent. Moreover, without delays (i.e., $\tau_1 = \tau_2 = \tau_w = \tau_p = 0$), the proposed control structure is equivalent to the conventional PD control law in (2). The main advantage of the proposed control structure is that the internal delays are removed from the feedback loop of the closed-loop subsystems. Therefore, the SBW system (1) with the control architecture of Fig. 3 is

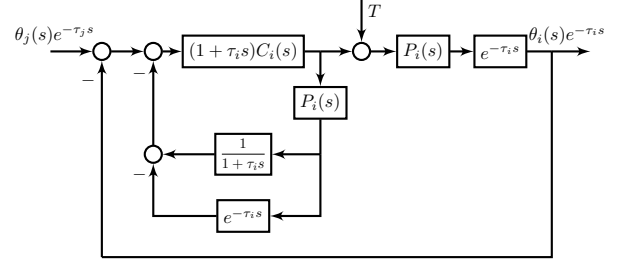

Fig. 3: Steering wheel/Road wheel subsystems block diagram with modified Smith predictor.

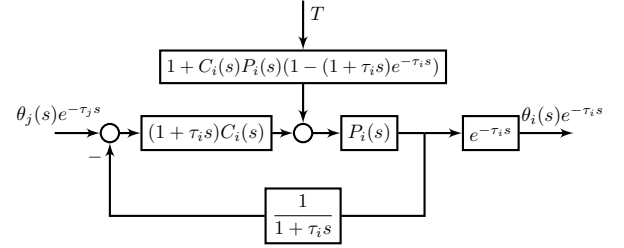

Fig. 4: Steering wheel/Road wheel subsystems block diagram with modified Smith predictor.

represented by the interconnected system in Fig. 5. Where, from the closed-loop SBW system, we define the open-loop transfer function L given by

$$\begin{aligned} L(s) &= -\frac{(1 + \tau_w s)C_w(s)P_w(s)}{1 + C_w(s)P_w(s)} \\ &\quad \times \frac{(1 + \tau_p s)C_p(s)P_p(s)}{1 + C_p(s)P_p(s)}. \end{aligned} \quad (5)$$

3. STABILITY ANALYSIS

To check the stability of the interconnected system, we use the Nyquist criterion [8] which provides a convenient way to examine stability for linear time-delay systems.

Proposition 1 *Given the system in (1)-(2) without delays (i.e., $\tau_1 = \tau_2 = \tau_w = \tau_p = 0$), the closed-loop system is stable for any positive values of the control parameters k_w, k_p, ρ_w , and ρ_p .*

The *delay margin* [9] of a feedback loop with a single delay is the bound $\Delta\tau$ such that the closed-loop system is stable for any delay in the interval $[0, \Delta\tau)$. From Proposition 1, the system (1)-(2) is stable for any values of the control parameters k_w, k_p, ρ_w , and ρ_p if $\tau_1 = \tau_2 = \tau_w = \tau_p = 0$. We will study below the stability of the system, to obtain the largest value of the *round trip delay* $\bar{\tau}_R$ such that the feedback loop in Fig. 5 is stable for all delay values in the set $\{(\tau_1, \tau_2, \tau_w, \tau_p) \mid \tau_1 + \tau_2 + \tau_w + \tau_p < \bar{\tau}_R\}$.

From the open-loop transfer function in (5), the unity-gain crossover frequencies ω_c are the real positive solutions of the equation $|L(j\omega_c)| = 1$. Finding the explicit expression for the solutions ω_c of

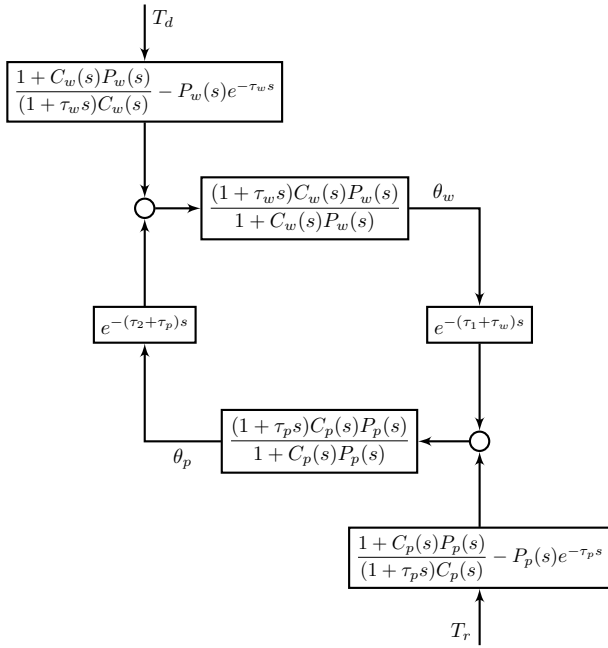

Fig. 5: SBW block diagram with modified Smith predictor controllers.

this equation is difficult since the characteristic equation is a polynomial of degree 4. Nevertheless, we can determine conditions under which the unity-gain crossover frequency ω_c of L exists and is unique as detailed in the following proposition.

Proposition 2 *If the control parameters k_w , ρ_w , k_p , ρ_p verify*

$$\begin{cases} a > 0, \\ d < 0, \\ b^2 c^2 + 18abcd < 27a^2 d^2 + 4ac^3 + 4b^3 d, \end{cases}$$

where

$$\begin{aligned} a &= J_w^2 J_p^2 - \tau_w^2 \tau_p^2 \rho_w^2 \rho_p^2, \\ b &= J_w^2 (\rho_p + \sigma_p)^2 + J_p^2 (\rho_w + \sigma_w)^2 - 2k_w J_w J_p^2 \\ &\quad - 2k_p J_p J_w^2 - \tau_w^2 \rho_w^2 (\tau_p^2 k_p^2 + \rho_p^2) \\ &\quad - \tau_p^2 \rho_p^2 (\tau_w^2 k_w^2 + \rho_w^2), \\ c &= 4k_w k_p J_w J_p + k_w^2 J_p^2 + k_p^2 J_w^2 - 2k_w J_w (\rho_p + \sigma_p)^2 \\ &\quad - 2k_p J_p (\rho_w + \sigma_w)^2 + (\rho_w + \sigma_w)^2 (\rho_p + \sigma_p)^2 \\ &\quad - \tau_w^2 k_p^2 \rho_w^2 - \tau_p^2 k_w^2 \rho_p^2 - (\tau_w^2 k_w^2 + \rho_w^2) (\tau_p^2 k_p^2 + \rho_p^2), \\ d &= k_w^2 (\rho_p + \sigma_p)^2 + k_p^2 (\rho_w + \sigma_w)^2 - 2k_w J_w k_p^2 \\ &\quad - 2k_p J_p k_w^2 - k_w^2 \rho_p^2 - k_p^2 \rho_w^2 - \tau_w^2 k_w^2 k_p^2 - \tau_p^2 k_w^2 k_p^2, \end{aligned}$$

then, the unity-gain crossover frequency ω_c of L exists and is unique.

Below, we assume that the conditions on the control parameters given in Proposition 2 hold. This is a realistic assumption since it is usually verified in conventional SBW systems. These conditions give an upper bound on the admissible round trip delay $\bar{\tau}_R$ as shown in the following theorem. However,

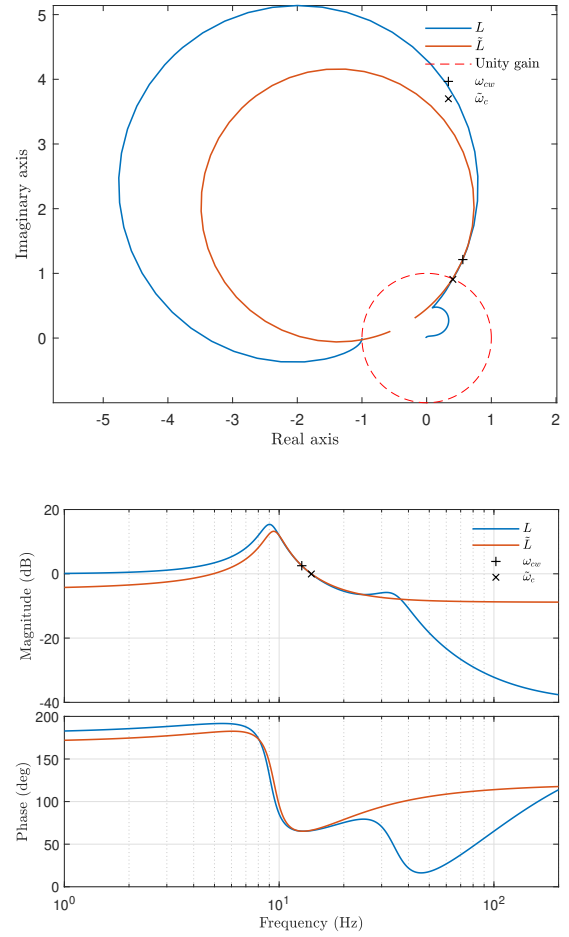

Fig. 6: Approximation at ω_{cw} of the open-loop transfer function L , for $\tau_w = \tau_p = 5$ ms: (top) Nyquist locus. (bottom) Bode diagram.

it is also possible to find conditions on the control parameters to ensure stability independently of the delays.

Theorem 1 *Assume that the unity-gain crossover frequency ω_c of L exists and is unique. For the interconnected system given by Fig. 1 and Fig. 3, there exists a constant $\bar{\tau}_R$ such that the closed-loop system is stable for all the delay values in the set $\{(\tau_1, \tau_2, \tau_w, \tau_p) \mid \tau_1 + \tau_2 + \tau_w + \tau_p < \bar{\tau}_R\}$.*

Table 1: SBW and controller parameters.

Parameter	Value
J_w	0.044 Kg.m ²
J_p	0.11 Kg.m ²
k_w	143.24 Nm/rad
k_p	$36k_w$ Nm/rad
ρ_w	0.25 Nm.s/rad
ρ_p	7.75 Nm.s/rad
σ_w	0.25 Nm.s/rad
σ_p	1.34 Nm.s/rad

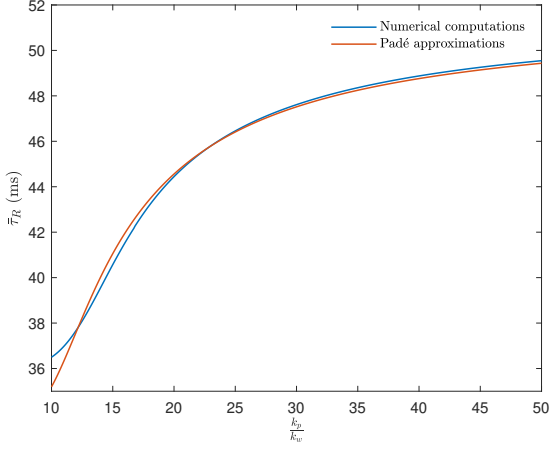

Fig. 7: Comparison between the delay margins $\bar{\tau}_R$ at several values of $\frac{k_p}{k_w}$, for $\tau_w = \tau_p = 5$ ms.

In this case, the delay margin is given by

$$\bar{\tau}_R = \frac{\arg(L(j\omega_c)) + \pi}{\omega_c}, \quad (6)$$

and the unity-gain crossover frequency ω_{cw} of the steering wheel subsystem, given by

$$\omega_{cw}^2 = \max\left(0, \frac{-(\rho_w + \sigma_w)^2 + \rho_w^2 + 2k_w J_w}{J_w^2}\right),$$

provides a first estimate of the solution ω_c . Below, we propose an approach to obtain a tighter estimate of ω_c .

First, we approximate the transfer function L using a Padé approximation at ω_{cw} , defined by a first order transfer function \tilde{L} with complex coefficients. That is, based on the Taylor series, we approximate separately the numerator

$$N_L(s) = -(1 + \tau_w s)(1 + \tau_p s)(\rho_w s + k_w)(\rho_p s + k_p)$$

and the denominator

$$D_L(s) = (J_w s^2 + (\sigma_w + \rho_w)s + k_w) \times (J_p s^2 + (\sigma_p + \rho_p)s + k_p)$$

of L in the neighborhood of ω_{cw} to obtain

$$\begin{aligned} \tilde{L}(j\omega) &= \frac{N_L(j\omega_{cw}) + j(\omega - \omega_{cw})\frac{dN_L}{ds}(j\omega_{cw})}{D_L(j\omega_{cw}) + j(\omega - \omega_{cw})\frac{dD_L}{ds}(j\omega_{cw})} \\ &= \frac{aj\omega + b}{cj\omega + d}, \end{aligned}$$

where a , b , c , and d are complex coefficients

$$\begin{aligned} a &= \frac{dN_L}{ds}(j\omega_{cw}), \\ b &= N_L(j\omega_{cw}) - j\omega_{cw} \frac{dN_L}{ds}(j\omega_{cw}), \\ c &= \frac{dD_L}{ds}(j\omega_{cw}), \\ d &= D_L(j\omega_{cw}) - j\omega_{cw} \frac{dD_L}{ds}(j\omega_{cw}). \end{aligned}$$

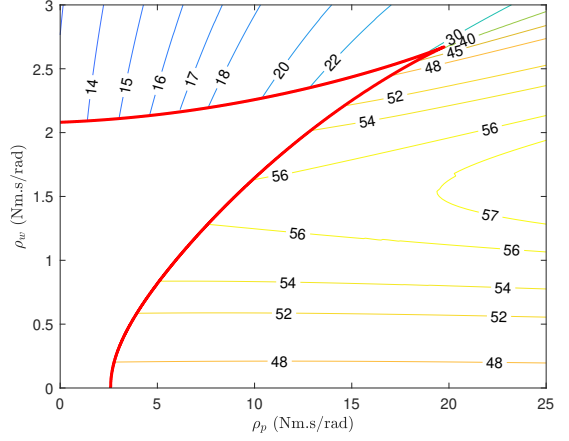

Fig. 8: Delay margin contours, in (ms), for $\tau_w = \tau_p = 5$ ms. The conditions of Proposition 2 do not hold inside the domain bounded by the red curve.

This approximation generates a circle tangent at ω_{cw} to the Nyquist locus (Fig. 6). The unity-gain crossover frequency $\tilde{\omega}_c$ of \tilde{L} can be calculated analytically since the characteristic equation is a polynomial of degree 2. It is given by

$$\tilde{\omega}_c = \frac{-(b_i a_r - b_r a_i - d_i c_r + d_r c_i) - \sqrt{\Delta}}{a_r^2 + a_i^2 - c_r^2 - c_i^2},$$

with

$$\begin{aligned} \Delta &= (b_i a_r - b_r a_i - d_i c_r + d_r c_i)^2 \\ &\quad - (a_r^2 + a_i^2 - c_r^2 - c_i^2)(b_r^2 + b_i^2 - d_r^2 - d_i^2), \end{aligned}$$

where a_r , a_i , b_r , b_i , c_r , c_i , d_r , and d_i are, respectively, the real and imaginary parts of a , b , c , and d .

Therefore, since \tilde{L} is an approximation of L , $\tilde{\omega}_c$ approximates ω_c more precisely, which can be used to compute the delay margin $\bar{\tau}_R$ in (6).

The approximate values of the delay margins obtained by $L(j\tilde{\omega}_c)$ and $\tilde{\omega}_c$ in (6) are illustrated in Fig. 7. On the one hand, for small values of $\frac{k_p}{k_w}$, the unity-gain crossover frequencies of the steering wheel subsystem and that of the road wheel subsystem are close, resulting in an abrupt change in the phase of the transfer function L . This change in phase generates a significant error in the estimation of the delay margin. On the other hand, when the value of $\frac{k_p}{k_w}$ is large (which is always the case in an assisted steering system), these two unity-gain crossover frequencies are far apart and, as a consequence, the unity-gain crossover frequency ω_{cw} is close to ω_c .

The assist gains k_w and k_p are fixed by the system requirement. The derivative gains ρ_w and ρ_p have a significant effect on the stability of the SBW system. However, determining an explicit expression for the values of the parameters ρ_w and ρ_p that maximizes the delay margin is difficult [10, Theorem 3.1]. Fig. 8 shows that the derivative gains ρ_w and ρ_p have a non-monotonic effect on the delay margin.

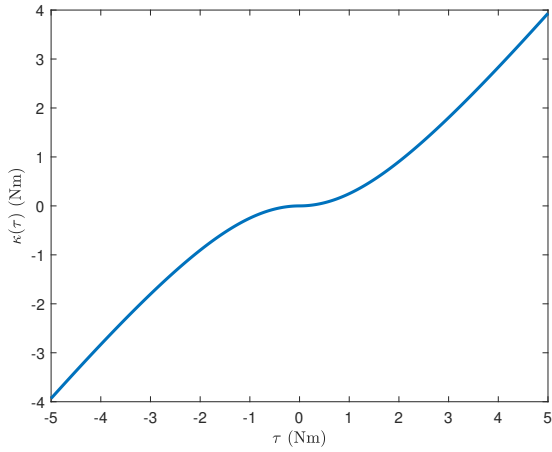

Fig. 9: Normalized nonlinear torque map.

Table 2: Simulation cases.

Delay	Case 1	Case 2	Case 3
τ_w (ms)	2.5	5	5
τ_p (ms)	2.5	5	5
τ_1 (ms)	5	5	10
τ_2 (ms)	5	5	10
$\bar{\tau}_R$ (ms)	46.04	48.47	48.47

4. SIMULATION

In this section, we compare the performance of the proposed modified Smith predictor and the conventional PD controller at same control parameter values as reported in Table 1.

We assume that the road torque is given by

$$T_r(t) = -k_r \theta_p(t) - \rho_r \dot{\theta}_p(t), \quad (7)$$

where $k_r = 300$ Nm/rad and $\rho_r = 25$ Nm.s/rad. To obtain a more realistic steering feel [11], we introduce a nonlinear torque map κ in the control law T_p ,

$$T_p(t) = k_w(\theta_w(t - \tau_1 - \tau_w) - \theta_p(t - \tau_p)) + \frac{(k_p - k_w)}{k_w} \kappa(k_w(\theta_w(t - \tau_1 - \tau_w) - \theta_p(t - \tau_p))) + \rho_p(\dot{\theta}_w(t - \tau_1 - \tau_w) - \dot{\theta}_p(t - \tau_p)),$$

where κ is illustrated in Fig. 9 and $k_p > k_w$.

We simulate the SBW system in three different cases, in which we change the values of the delays as depicted in Table 2. In each case, we consider two scenarios: the first scenario, a square-like steering torque input is applied and the control signal are examined; the second scenario, a sinusoidal steering torque input of amplitude 5 Nm and frequency of 0.1 Hz is applied and the steering wheel angle is plotted with respect to the driver steering torque. The performance of the system is measured by the *hysteresis* generated by this curve. That is, by the distance between the two intersection points with the imaginary axis at $\theta_w = 0$ deg.

For Case 1, since the values of the delays are small, the two controllers have approximately the

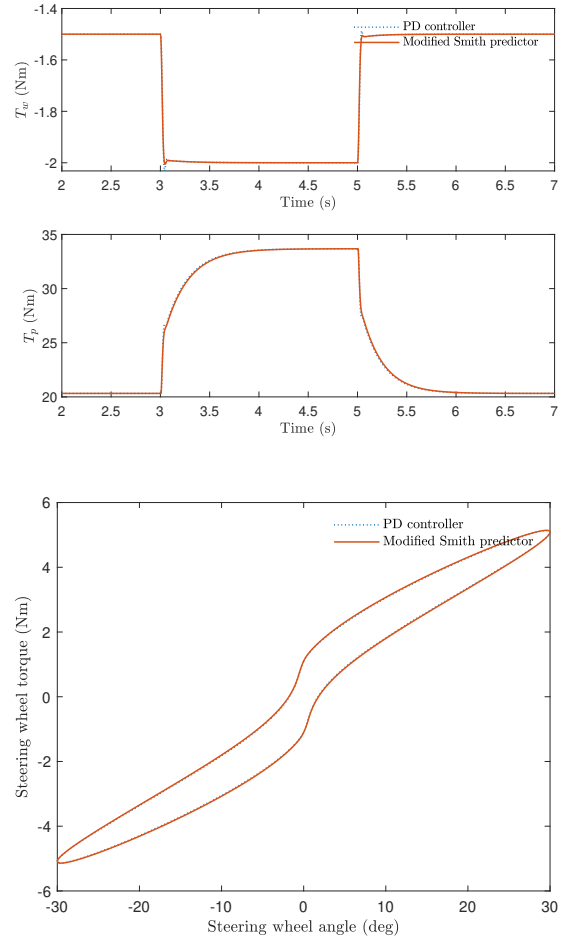

Fig. 10: Case 1: (top) Control signals for a square-like steering torque input. (bottom) SBW steering feel for a sinusoidal driver torque input.

same performance, as shown in Fig. 10. For Case 2, as shown in Fig. 11, the modified Smith predictor compensates the internal delays and performs almost as in Case 1. However, the PD controller exhibits slight vibrations. These vibrations are a result of the fact that the internal delays are still present in the feedback loop of the steering wheel and road wheel subsystems. For Case 3, where we consider larger communication delays $\tau_1 + \tau_2 + \tau_w + \tau_p = 30$ ms, as shown in Fig. 12, the modified Smith predictor starts to oscillate since we approach the delay margin $\bar{\tau}_R = 48.47$ ms.

5. CONCLUSION

This paper studied a SBW control law based on PD schemes. To circumvent their reduced delay margin, in the case of high feedback gains, a modified Smith predictor was introduced to compensate for internal delays and reduce transient oscillations. Moreover, an approximation of the delay margin based on a Padé approximation of the open-loop transfer function was proposed. Finally, to assess the performance of the proposed control laws, the “steering feel” of the system was evaluated for a specific driver input.

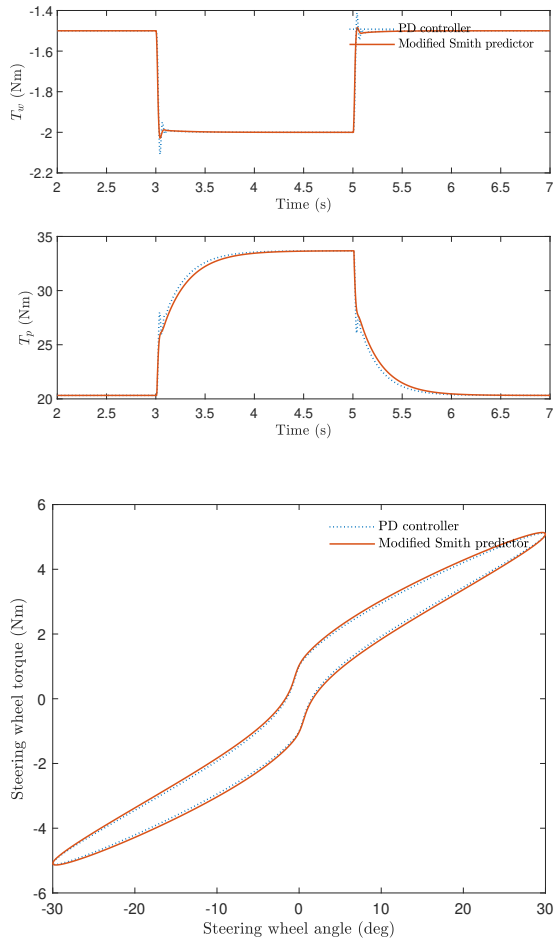

Fig. 11: Case 2: (top) Control signals for a square-like steering torque input. (bottom) SBW steering feel for a sinusoidal driver torque input.

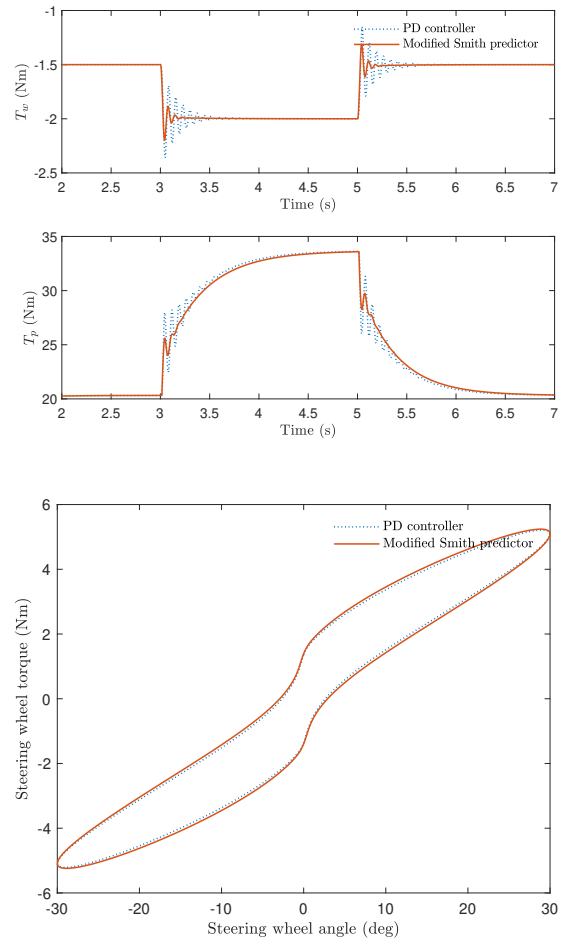

Fig. 12: Case 3: (top) Control signals for a square-like steering torque input. (bottom) SBW steering feel for a sinusoidal driver torque input.

REFERENCES

- [1] T. Van der Sande, P. Zegelaar, I. Besselink, and H. Nijmeijer. A robust control analysis for a steer-by-wire vehicle with uncertainty on the tyre forces. *Vehicle System Dynamics*, 54(9):1247–1268, 2016.
- [2] D. Lee and M. Spong. Passive bilateral teleoperation with constant time delay. *IEEE Transactions on Robotics*, 22(2):269–281, 2006.
- [3] P. Yih and J. Gerdes. Modification of vehicle handling characteristics via steer-by-wire. *IEEE Transactions on Control Systems Technology*, 13(6):965–976, 2005.
- [4] E. Nuño, I. Sarras, A. Loria, M. Maghenem, E. Cruz-Zavala, and E. Panteley. Strict Lyapunov–Krasovskii Functionals for undirected networks of Euler–Lagrange systems with time-varying delays. *Systems & Control Letters*, 135:104579, 2020.
- [5] K. Watanabe and M. Ito. A process-model control for linear systems with delay. *IEEE Transactions on Automatic control*, 26(6):1261–1269, 1981.
- [6] K. J. Astrom, C. C. Hang, and B. C. Lim. A new Smith predictor for controlling a process with an integrator and long dead-time. *IEEE transactions on Automatic Control*, 39(2):343–345, 1994.
- [7] A. Bahill. A simple adaptive Smith-predictor for controlling time-delay systems: A tutorial. *IEEE Control Systems Magazine*, 3(2):16–22, 1983.
- [8] K. Walton and J. E. Marshall. Direct method for tds stability analysis. *IEE Proceedings D-Control Theory and Applications*, 134(2):101–107, 1987.
- [9] R. H. Middleton and D. E. Miller. On the achievable delay margin using LTI control for unstable plants. *IEEE Transactions on Automatic Control*, 52(7):1194–1207, 2007.
- [10] D. Ma, J. Chen, A. Liu, J. Chen, and S. I. Niculescu. Explicit bounds for guaranteed stabilization by pid control of second-order unstable delay systems. *Automatica*, 100:407–411, 2019.
- [11] Y. Li, T. Shim, D. Wang, and T. Offerle. Study on parameters affecting steering feel of column assist electric power steering. *International Journal of Vehicle Design*, 77(3):153–179, 2018.