



HAL
open science

Stabilization of lean flames with nanosecond discharges in a gas turbine model combustor

Victorien P Blanchard, Frédéric Roqué, Philippe Scoufflaire, Christophe O
Laux, Sebastien Ducruix

► **To cite this version:**

Victorien P Blanchard, Frédéric Roqué, Philippe Scoufflaire, Christophe O Laux, Sebastien Ducruix. Stabilization of lean flames with nanosecond discharges in a gas turbine model combustor. AIAA SCITECH 2023 Forum, AIAA SCITECH 2023 Forum, American Institute of Aeronautics and Astronautics, 2023, 10.2514/6.2023-2387 . hal-03966404

HAL Id: hal-03966404

<https://centralesupelec.hal.science/hal-03966404>

Submitted on 31 Jan 2023

HAL is a multi-disciplinary open access archive for the deposit and dissemination of scientific research documents, whether they are published or not. The documents may come from teaching and research institutions in France or abroad, or from public or private research centers.

L'archive ouverte pluridisciplinaire **HAL**, est destinée au dépôt et à la diffusion de documents scientifiques de niveau recherche, publiés ou non, émanant des établissements d'enseignement et de recherche français ou étrangers, des laboratoires publics ou privés.

Stabilization of lean flames with nanosecond discharges in a gas turbine model combustor

Victorien P. Blanchard¹, Frédéric Roqué², Philippe Scoufflaire³,
Christophe O. Laux⁴, and Sébastien Ducruix⁵

*Université Paris-Saclay, Laboratoire EM2C, CNRS, CentraleSupélec, 3, rue Joliot-Curie, 91190
Gif-sur-Yvette*

This work presents an experimental study of the stabilization of lean methane-air flames by nanosecond repetitively pulsed (NRP) discharges. The experimental facility consists of a gas turbine model combustor with a Lean Premixed Prevaporized multipoint injector. The fuel is injected through two stages, each stabilized by swirl. This facility is representative of a single sector of a gas turbine combustion chamber. The NRP discharges are found to significantly extend the lean blow-off limit for a wide range of operating conditions, with flame thermal powers up to 100 kW, and with an electric power less than 0.2% of the flame thermal power.

I. Nomenclature

<i>BVB</i>	=	Bubble Vortex Breakdown
<i>CRZ</i>	=	Central Recirculation Zone
<i>CVB</i>	=	Conic Vortex Breakdown
<i>ISL</i>	=	Inner Shear Layer
<i>LBO</i>	=	Lean Blow-Off
<i>LPP</i>	=	Lean Premixed Prevaporized
<i>NRP</i>	=	Nanosecond Repetitively Pulsed
<i>OSL</i>	=	Outer Shear Layer
<i>UHC</i>	=	Unburnt Hydrocarbons

II. Introduction

The development of combustion chambers for future gas turbines and, more specifically, aircraft engines is driven by the reduction of NO_x, particulate matters, CO, and unburnt hydrocarbons (UHC) emissions, the ability to reignite in severe conditions (mainly at high-altitude and in cold environments), the improvement of combustion efficiency, and the mitigation of combustion instabilities. One strategy to tackle these challenges is to operate in the lean premixed combustion regime. It involves the design of new injector technologies relying mainly on an efficient fuel-air mixing and on the use of a swirling flow to aerodynamically stabilize the flame [1]. However, lean flames are prone to instabilities and lean extinction. Plasma discharges have produced remarkable results to efficiently sustain the combustion of lean flames [2,3]. In particular, Nanosecond Repetitively Pulsed (NRP) discharges are a promising candidate for plasma-assisted combustion in practical applications because they produce high amounts of radicals with a very low power budget [4,5]. Laboratory-scale burners dedicated to plasma-assisted combustion

¹ Ph. D. Student

² Ph. D. Student

³ Research engineer

⁴ Senior scientist, AIAA Associate Fellow

⁵ Professor, AIAA Fellow

usually operate at low power, and only a few studies focus on swirled-stabilized burners. Barbosa *et al.* [6] showed that NRP discharges applied at 30 kHz were able to drastically extend the lean blow-off (LBO) limit of propane-air flames up to 50 kW. Xiong *et al.* [7] have also shown that NRP discharges were able to stabilize the second stage chamber of a 50-kW sequential burner with only 100 W of plasma power. Lacoste *et al.* [8] showed that NRP discharges can suppress self-sustained thermo-acoustic instabilities in a lean, premixed, methane-air, swirl-stabilized burner at 4 kW. Moeck *et al.* [9] demonstrated that NRP discharges can reduce the noise level by a factor of 5 in a 43-kW lean premixed natural gas-air flame. Still, they observed that the discharges promoted strong oscillations at higher power. The effect of the pressure on plasma-assisted flames was studied by Di Sabatino and Lacoste [10]. They used NRP discharges to extend the stability domain and the LBO limit of swirl premixed methane-air flames for pressures up to 5 bar for flame thermal powers varying between 5 and 20 kW. Vignat *et al.* [11] investigated the ability of NRP discharges to extend the LBO limit of liquid fuels. Using a single swirl-stabilized burner at atmospheric pressure, perfectly premixed methane-air and sprays of liquid heptane, and liquid dodecane were injected during successive experiments into the 5-kW burner. A substantial extension of the LBO limit for the three fuels was obtained with NRP discharges. Finally, the impact on NO_x emissions of NRP discharges during flame stabilization was studied by Kim *et al.* [12]. They showed that the combustion efficiency of lean, premixed, methane-air, 6-kW flames was increased by 10% with a minimal NO_x penalty. This represents a gain of 500 W of flame thermal power for an electric power input of only 30 W. They demonstrated that a change in flame shape induced by NRP discharges significantly reduces the pressure fluctuation in the combustion chamber. They developed an active control scheme and obtained promising results. All these studies pave the way towards developing practical implementations of NRP discharges in gas turbine combustors for aeronautical propulsion or energy production. However, there is a lack of studies in higher power combustors with injectors representative of practical applications. This work seeks to investigate the performance of a 100-kW swirled burner with a two-stage Lean Premixed Prevaporized (LPP) injector stabilized by NRP discharges under lean conditions.

III. Experimental setup

A. A gas turbine model combustor for plasma-assisted combustion: BIMER-PAC facility

The burner, shown in Fig. 1, consists of a combustion chamber with a square cross-section of 15 cm x 15 cm and a length of 50 cm. It is dedicated to plasma-assisted combustion studies and has been duplicated from an existing facility [13–15]. In this study, the burner is operated with gaseous methane at atmospheric pressure. The chamber backplane, as well as its upper and lower walls, are water-cooled to ensure thermal equilibrium when operating at steady conditions. The side walls are made of silica to provide wide optical access. Two silica windows facing each other are inserted in the upper and lower walls close to the injector for laser diagnostics. K-type thermocouples are mounted in the water-cooling circuit of each wall to monitor the temperature and possibly deduce the heat flux extracted at the walls. One thermocouple is inserted in the injector downstream of the multipoint stage swirling vane to detect flame flashback. To monitor the wall surface temperature, two thermocouples are integrated in the lower wall via blind holes less than 1 mm from the wall inner surface so that the thermocouples do not receive radiation from the flame. They are located along the centerline of the wall at 25 cm and 42 cm from the chamber backplane, respectively.

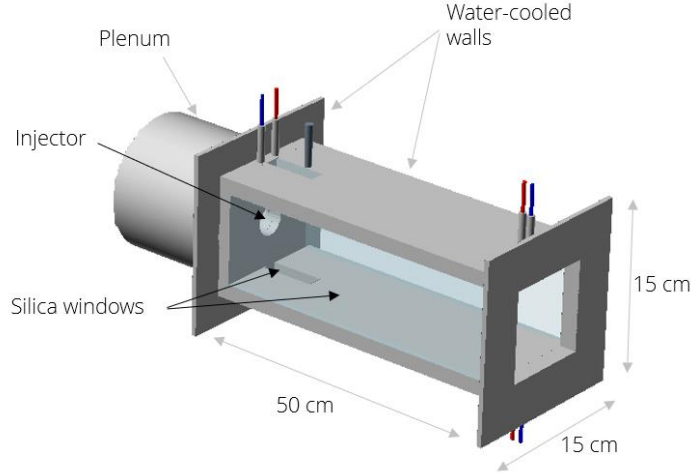

Fig. 1 Combustor of the BIMER-PAC facility, adapted from [15].

The aircraft injector mounted in the combustor is represented in Fig. 2. It comprises: i) a pilot stage with a central injection tube (4 mm in diameter) and the associated radial swirler, and ii) a multipoint stage where the fuel is fed through 15 equally spaced holes (0.7 mm in diameter) in a crossflow of air downstream of a second radial swirler to enable efficient turbulent mixing of fuel and air. This LPP injector design provides realistic air-fuel injection and an engine-like recirculation zone in the combustion chamber. The pilot stage creates a fuel-rich region to anchor the flame. The multipoint stage is designed to ensure good mixing of fuel and air to operate in lean-premixed conditions. In this study, we use gaseous methane. The methane flow rate in each stage is independently controlled to vary the fuel staging factor (Bronkhorst Cori-Flow M55-RAD-44-0-S, Bronkhorst EL-Flow F-203AC-AAD-44-V). The fuel staging factor, α , is defined as the ratio of the fuel flow rate injected through the pilot stage and of the total fuel flow rate.

$$\alpha = \frac{\dot{Q}_{CH_4,pilot}}{\dot{Q}_{CH_4,multi} + \dot{Q}_{CH_4,pilot}} \quad (1)$$

where $\dot{Q}_{CH_4,pilot}$ and $\dot{Q}_{CH_4,multi}$ are the methane flow rates through the pilot stage and the multipoint stage, respectively. The air flow rate is controlled by a single mass flow controller. Air is fed in the plenum and naturally splits into a 20-80% distribution between the co-rotating pilot and multipoint swirlers, respectively, due to head losses [13]. Depending on the air flow rate we use either a mass flow controller with a full scale of 71.5 g.s⁻¹ (Bronkhorst EL-Flow F-206BI-FA-00-V) or a mass flow controller with a full scale of 214.5 g.s⁻¹ (Bronkhorst MassStream D-6391-DR/003BI). The global equivalence ratio, denoted Φ_g , is defined as the total methane-to-air mass flow rate ratio divided by the stoichiometric methane-to-air mass flow rate ratio. Given the air distribution between the two stages and the fuel staging factor, we define the (theoretical) local equivalence ratios Φ_p and Φ_m for the pilot stage and the multipoint stage, respectively by:

$$\Phi_p = 5\alpha\Phi_g \quad (2)$$

$$\Phi_m = 1.25(1 - \alpha)\Phi_g \quad (3)$$

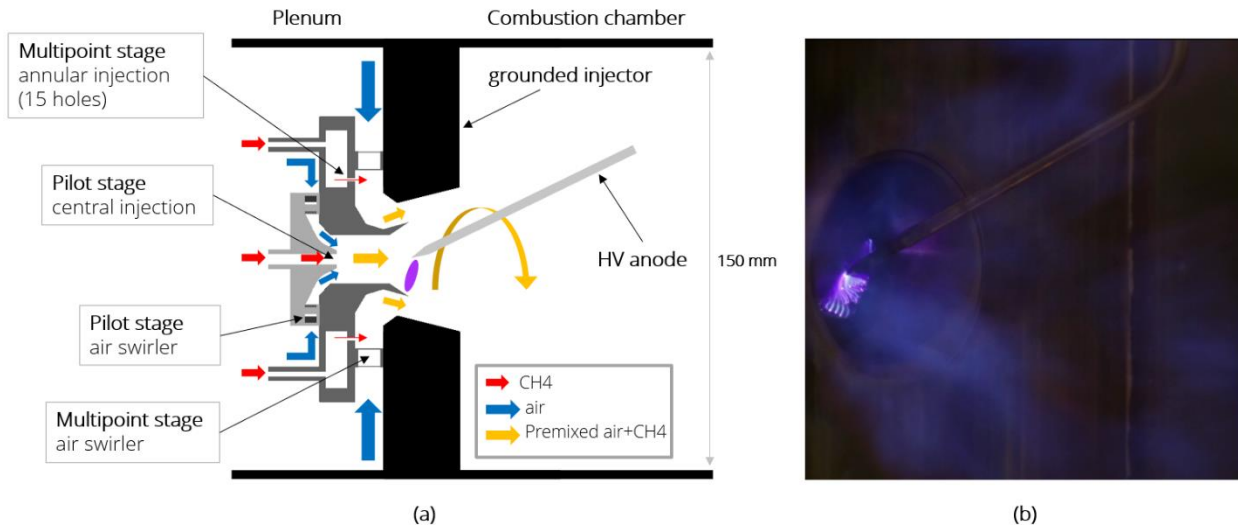

Fig. 2 (a) Schematic of the two-stage injector with the high-voltage electrode. (b) Photograph of the electrode with NRP discharges applied in a 60-kW flame. Credit Auguste & Louise SARRL.

The nanosecond discharges are produced between a water-cooled pin electrode and the rim of the grounded pilot stage, as shown in Fig. 2. The pulses are applied at repetition frequencies between 33 kHz and 77 kHz, with a maximal energy input per pulse of 4 mJ, delivered by a 10-ns-duration high-voltage pulse generator (FID Technology 15-100NM10).

An ICCD camera (Princeton Instruments, PI-MAX 4) fitted with a 50-mm lens (Nikon, AF Nikkor f/1.4) and a bandpass filter (Asahi spectra, F0101, CWL = 430 nm) centered on the CH* chemiluminescent emission facing one of the silica windows is used for flame imaging. The images presented in this article were recorded with a gate width of 200 μ s, integrated along the line of sight, and averaged over 200 samples.

B. Discharge electrical characterization

Voltage and current waveforms are measured with electric probes (Lecroy PPE 20kV, Pearson current monitor model 6585) connected to an oscilloscope (TeledyneLecroy HDO 6104) in order to monitor the energy input of each discharge. The probes are located halfway along the coaxial cable using the configuration detailed in our previous work [16]. An example of typical voltage, current, and energy traces is plotted in Fig. 3. A first pulse with an amplitude of approximately 4 kV is delivered by the pulser. Due to the impedance mismatch between the coaxial cable and the interelectrode gap, the pulse is partially reflected at the electrode. The reflection travels back to the pulser where it is again reflected. All the energy is deposited into the gas after a few reflections at the electrode and at the pulser output. Note, however, that 75% of the energy is deposited by the first incident pulse. In the end, the average plasma electric power, P_{plasma} , is obtained by multiplying the total energy deposited by the repetition frequency of the NRP discharges.

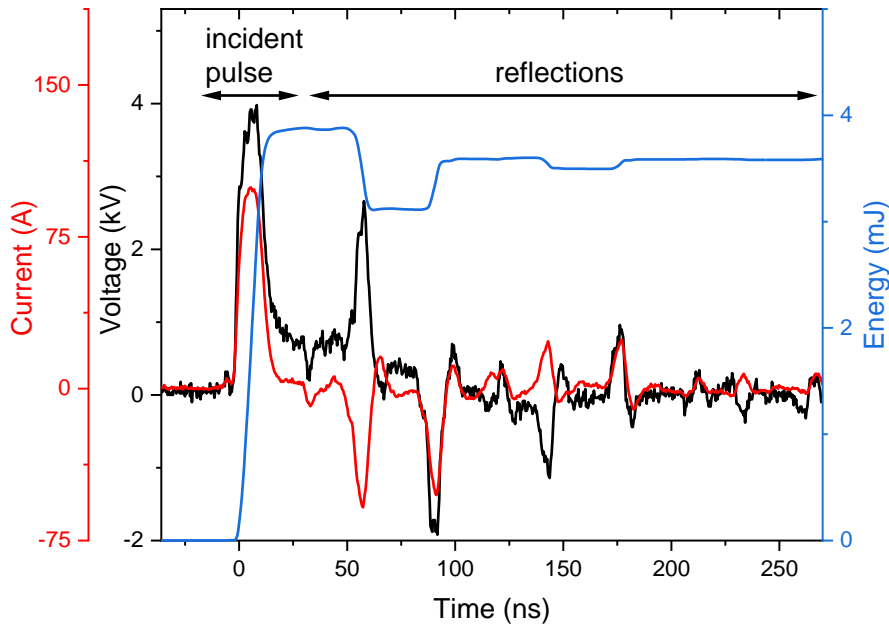

Fig. 3 Typical voltage, current, and energy traces measured during the experiments.

C. Lean blow-off limit determination

To determine the LBO limit of the burner at constant thermal power P_{flame} , we proceed as follows. First, we ignite a low power flame, and then we increase the flame power up to the targeted power at an equivalence ratio of 0.8 (or higher if the flame is not stable). To ensure reproducibility, this operating condition is maintained until the wall surface temperature, controlled with thermocouples, reaches steady state. Then, keeping the methane flow rates constant, the air flow rate is gradually increased to reduce the equivalence ratio until extinction. This procedure is repeated between 5 and 10 times for each operating condition studied. To investigate the influence of plasma on the lean blow-off, we first determine the limit without plasma and then with NRP discharges. The water-cooled electrode is always present in the chamber, whether the plasma is applied or not. When comparing the LBO limit with and without plasma, this ensures that the difference is only due to the presence of plasma.

IV. Lean blow-off extension with NRP discharges

In previous work, Barbosa *et al.* [6] used a similar burner with a two-stage multipoint injector. They showed that it is possible to extend the LBO limit of a propane-air flame with NRP discharges. They succeeded in sustaining lean flames down to a global equivalence ratio of 0.11. However, the equivalence ratio was reduced by decreasing the fuel flow rate. Hence, the flame thermal power was reduced accordingly during the experiments, and it remained below 50 kW. Moreover, most of the experiments were carried out with a fuel staging factor of 100% (pilot fuel configuration). Although these plasma-assisted combustion results are promising for practical applications, more work is needed, it is important to investigate higher flame thermal powers and other fuel staging factors. This is the objective of the present study.

A. Study of the extinction sequence without and with plasma

A typical LBO sequence without plasma is presented in Fig. 4. At 50 kW and $\alpha = 40\%$, the equivalence ratio is decreased by increasing the air flow rate while keeping the methane flow rate constant, i.e., constant thermal power. At $\Phi_g = 0.68$, we observe a stable V-shape flame. As the equivalence ratio is decreased, the emission of the flame is less intense, but the flame is still in a stable V-shape until $\Phi_g = 0.60$. Then, the flame becomes unstable, and it

abruptly blows off at $\Phi_g = 0.56$. This extinction sequence is reproducible and always exhibits the same characteristics.

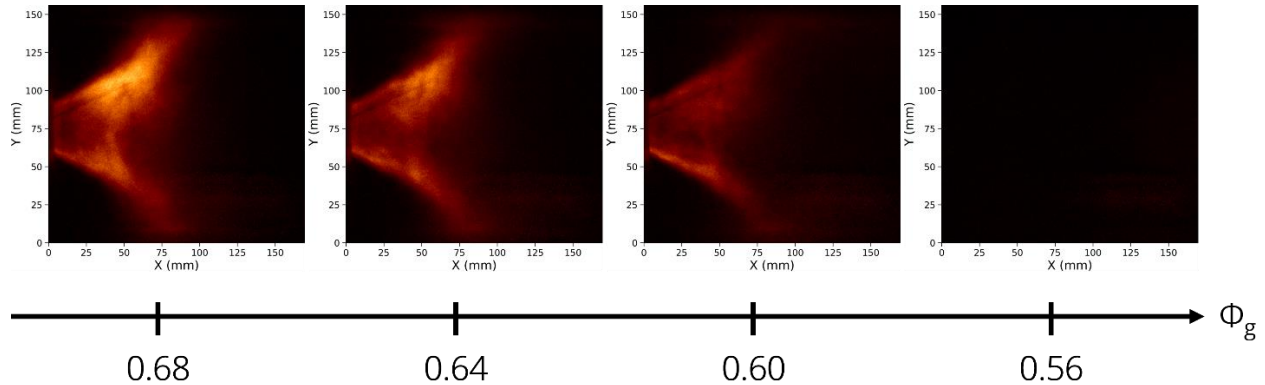

Fig. 4 CH* chemiluminescence images of the LBO sequence of a 50-kW flame at $\alpha = 40\%$, without NRP discharges.

The V-shape flame is commonly found in swirl-stabilized combustors. It was observed experimentally by Renaud *et al.* [17] using a similar combustor with the same injector designed for liquid fuel. The flame of Renaud *et al.* was numerically reproduced in Large Eddy Simulations by Mesquita *et al.* [18,19] who explained the flame topology. Such calculations have not been performed so far in our gaseous case. Still, we assume that we can draw some conclusions on the flame topology from the knowledge of the liquid case simulations [19] which were initially carried out to study flame dynamics with no link to plasma-assisted combustion.

Shear layers usually favor flame stabilization due to a reduced flow velocity and enhanced mixing. The V-shape flame basis is anchored within the pilot stage and is stabilized over the inner shear layer (ISL), delimiting the central recirculation zone (CRZ) induced by the swirl motion of the flow. The CRZ of a V-shape flame is governed by a conical vortex breakdown (CVB) mode [20,21] with the tip of the CRZ lying within the divergent of the injector. The CRZ radius increases linearly along the chamber axis, drawing the V-shape of the ISL and, thus, the shape of the flame.

We see in Fig. 4 that the flame is not perfectly axisymmetric, possibly because the electrode creates recirculation patterns. All experiments, with and without plasma, are performed with the electrode in place to solely investigate the NRP discharges effect.

The experiment was repeated under the same conditions, but this time with NRP discharges applied at 33 kHz with an average deposited energy of 3.6 mJ. The images are shown in Fig. 5. The behavior down to $\Phi_g = 0.60$ is similar to the case without plasma. When the equivalence ratio is further decreased, the flame becomes unstable, but blow-off does not occur, and the flame is sustained through this unstable region between $\Phi_g = 0.56$ and $\Phi_g = 0.48$. This instability is characterized by the oscillation of the flame between the V shape and the tulip shape. When the fuel equivalence ratio is further reduced, the flame enters again into a stable regime, with a stable tulip-shape flame between $\Phi_g = 0.44$ and $\Phi_g = 0.38$. Once the flame is in the tulip shape, it gradually attenuates until it blows off.

The tulip-shape flame differs from the V-shape flame due to a CRZ resulting from a bubble vortex breakdown (BVB) [19]. In that case, the opening of the CRZ is less pronounced, bent and exhibits a clear constriction leading to its closing. It has the appearance of a tulip. The flame is anchored within the injector, and its branches are stabilized over the ISL. An interesting feature of the tulip flame is its flow topology governed by a BVB mode similar to the cold flow, whereas the feedback of the V-flame on the flow leads to a CVB mode [19]. When decreasing the equivalence ratio by increasing the air flow rate, we thus observe the transition from a CVB mode to a BVB mode. Without plasma, this transition leads to flame extinction. However, when NRP discharges are applied, the combustion is maintained throughout the transition, and we obtain a stable tulip flame until lean extinction.

In the case without plasma, extinction is thus triggered by the transition from the V-shape to the tulip-shape flame. It is then legitimate to wonder whether the NRP discharges are useful only to sustain the flame across the transition and whether the tulip-shape flame could exist without plasma. Turning off the NRP discharges once the flame is in the tulip shape leads to a non-immediate blow-off. However, this tulip flame without NRP discharges has a reduced lifetime; it lasts from a few seconds up to a couple of minutes but always extinguishes. The NRP

discharges are thus crucial in this extinction sequence first by avoiding flame blow-off during the transition and by stabilizing the tulip flame down to the LBO limit.

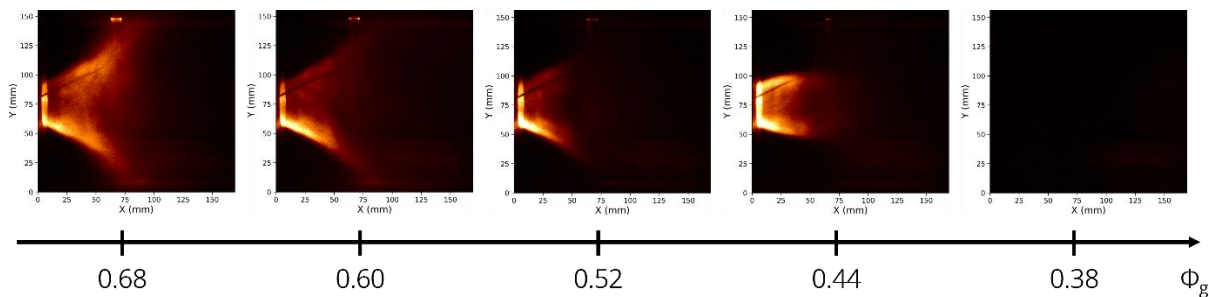

Fig. 5 CH* chemiluminescence images of the LBO sequence of a 50-kW flame at $\alpha = 40\%$ with 3.6-mJ NRP discharges applied at 33 kHz.

Moreover, the evolution of the flame shape with the equivalence ratio does not exhibit any hysteresis cycle. Increasing the equivalence ratio from $\Phi_g = 0.40$ to $\Phi_g = 0.68$, we observe the same region of existence for the tulip-shape flame, the transition, and the V-shape flame as what we observed when decreasing the equivalence ratio from $\Phi_g = 0.68$ to $\Phi_g = 0.40$.

B. LBO performance up to 100 kW

Three distinct extinction mechanisms are encountered: V-shape flame blow-off, tulip-shape flame blow-off, and lifting of the V-shape flame followed by the growth of the lift-off height until extinction. In the latter case, the lift-off height of the flame potentially extends to 40 cm, which means that there is still a burning region almost at the outlet of the combustion chamber. A typical example of a lifted flame is shown in Fig. 6. These lifted flames are not desired in practical applications because the combustion chamber should be as compact as possible, and the flame lift-off height is not precisely controlled. Such flames were observed by Renaud *et al.* [17] and simulated by Mesquita *et al.* [22]. The lifted flame has a flow topology characterized by a CRZ resulting from a BVB mode. In that case, the flame is stabilized over the outer shear layer (OSL) and is not anchored within the injector. Mesquita *et al.* concluded that they are not suitable for stage-injection combustors compared to other types of stabilized flame. In all the following experiments, the blow-off limit is defined as the point where the flame stops burning, or stops being anchored within the injector. We thus consider lifted flames as blown off.

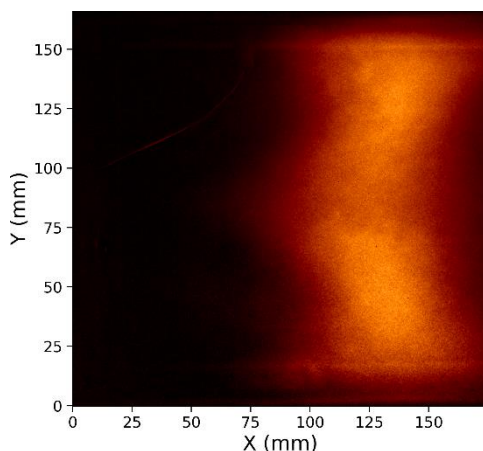

Fig. 6 CH* chemiluminescence image of a lifted flame: 50 kW, $\alpha = 0\%$, $\Phi_g = 0.8$, without NRP discharges.

The gain in the LBO limit with NRP discharges for 50-kW and 100-kW flames is quantified and represented in Fig. 7. The LBO limit of 50-kW flames is investigated for fuel staging factors, α , varying from 0% to 100%. For each flame, the global equivalence ratio at blow-off, Φ_{LBO} , is quantified without and with plasma following the procedure described in Section III.C. A value of $\alpha = 0\%$ corresponds to a methane injection through the multipoint stage only, and conversely, $\alpha = 100\%$ corresponds to a methane injection through the pilot stage only. For instance,

the LBO equivalence ratio of the pilot-only flame is 0.53 and 0.93 for the multipoint-only flame. This difference is explained by the extinction mechanisms at stake in these two cases. For the pilot-only flame, the V-shape flame without plasma is blown off, whereas for the multipoint-only flame, $\Phi_{\text{LBO}} = 0.93$ corresponds to the transition between the V-shape flame and the lifted flame. We observe that without plasma (black squares), the domain of existence of the flame in the lean regime increases as the fraction of methane through the pilot stage is higher.

For all experiments with plasma, the NRP discharges are applied at a repetition frequency of 33 kHz for the 50-kW flames. The discharge energy is between 3 and 3.7 mJ, resulting in a plasma electric power between 100 and 120 W. The evolution of the equivalence ratio at LBO with the fuel staging is similar to the case without plasma: a greater value of α leads to a better extension of the LBO limit. Moreover, we note that with the NRP discharges the domain of existence of lean flames is dramatically extended. For α between 20% and 100%, Φ_{LBO} is divided by a factor between 1.5 and 1.9. Moreover, the extinction sequences without and with plasma for all these values of α are similar to the case at $\alpha = 40\%$ presented in Section IV.A. Without plasma, the V-shape flame blows off while with plasma, there is a transition to the stable tulip-shape flame that blows off when the equivalence ratio is further decreased. At $\alpha = 0\%$, the extension of Φ_{LBO} with plasma is less pronounced. The flame lift-off is slightly delayed, but it is not possible to anchor the flame as the equivalence ratio is further reduced.

The 100-kW flames exhibit a behavior very similar to the 50-kW ones. The ability of NRP discharges to stabilize lean flames is strongly correlated to the change of flame shape. It is however necessary to apply the discharges at a higher repetition frequency to maintain the flame during the V-to-tulip flame transition. Interestingly, the repetition frequency also depends on the fuel staging factor. At $\alpha = 40\%$, 3.9-mJ discharges applied at 50 kHz are sufficient to stabilize the lean flame, but at $\alpha = 100\%$ the NRP discharges are applied at 77 kHz. This trend needs further investigation, but it indicates that the required plasma power decreases with the fuel staging, which is desirable as this injector is meant to operate with small values of α .

In summary, the plasma-to-flame power ratio for the 50-kW and 100-kW flames is between 0.19% and 0.3%. Since we did not perform any optimization on the energy deposition, these already low plasma power requirements are promising for future practical applications.

A single experiment at 150 kW and $\alpha = 40\%$ showed that the equivalence ratio at LBO can be extended from 0.56 without plasma to 0.42 with plasma. However, at such high power, we reached the safety limit for this facility.

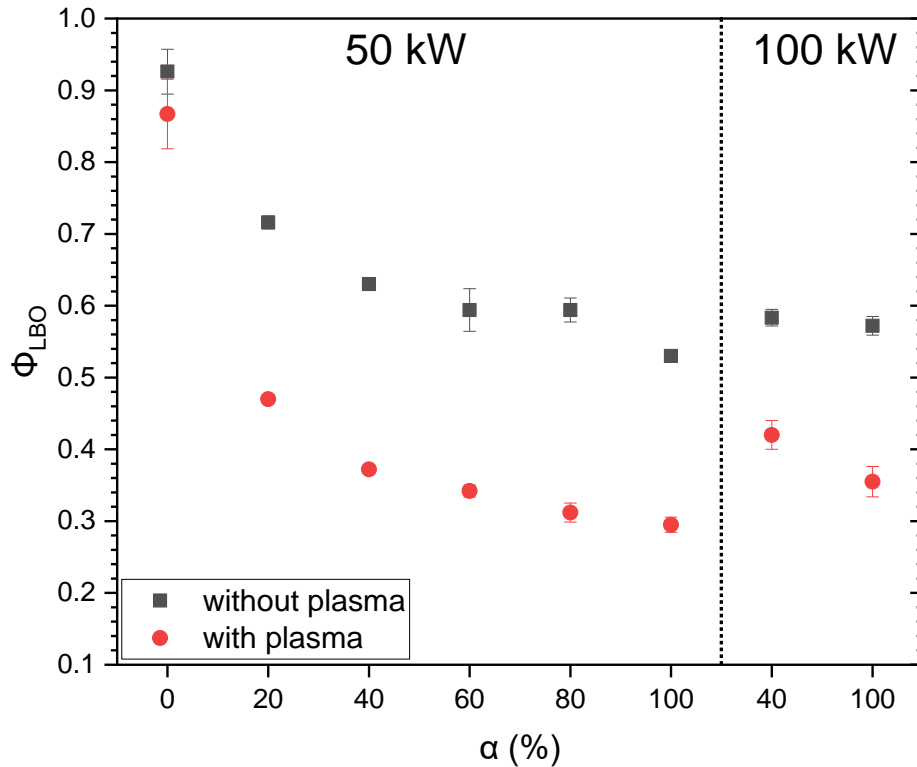

Fig. 7 Stability map of the burner with and without NRP discharges for different fuel staging factors and flame thermal powers. Error bars correspond to the standard deviation on the 5 measurements performed at each condition.

V. Conclusion

This study shows that NRP discharges are a promising candidate for widening the operability range and improving the performance of gas turbine engines. This work is novel in that it demonstrates the stabilization of lean flames up to 100 kW in a gas turbine model combustor with a two-stage LPP injector. The lean blow-off limit of swirl-stabilized flames is extended down to an equivalence ratio of 0.3, with a plasma-to-flame power ratio of only 0.19% without optimizing the energy deposited by the plasma.

In future work, gas analysis measurements will be performed to determine the combustion efficiency, CO, UHC, and NO_x emissions of the lean flames assisted by NRP discharges. Another objective will be to find a relevant electrode geometry and location to stabilize the flame when the burner operates in multipoint-only injection ($\alpha = 0\%$). The ultimate goal would be to suppress the pilot stage, which always locally creates non-premixed conditions, and keep only the multipoint stage that ensures a fully premixed lean combustion. Moreover, an optimization could also be carried out to minimize the plasma-to-flame power ratio while improving the combustion efficiency and minimizing the pollutant emissions. Finally, numerical simulations of plasma-assisted combustion in this burner, as done in [23,24], would help improve the understanding of the mechanisms at stake and thus optimize the combustor. This work will be useful to provide guidelines for the integration of NRP discharges in plasma-assisted combustors.

Acknowledgments

This work was funded by the French ANR grant PASTEC ANR16-CE22-0005 and the EU ERC grant GreenBlue ID: 101021538. A CC-BY public copyright license has been applied by the authors to the present document and will be applied to all subsequent versions up to the Author Accepted Manuscript arising from this submission, in accordance with the grant's open access conditions. The authors would like to thank Erika Jean-Bart, Yannick Le Teno, Hubert Jubeau, and Koro Sokhona for technical assistance with the experimental facility.

References

- [1] Huang Y and Yang V 2009 Dynamics and stability of lean-premixed swirl-stabilized combustion *Prog. Energy Combust. Sci.* **35** 293–364
- [2] Starikovskiy A and Aleksandrov N 2013 Plasma-assisted ignition and combustion *Prog. Energy Combust. Sci.* **39** 61–110
- [3] Ju Y and Sun W 2015 Plasma assisted combustion: Dynamics and chemistry *Prog. Energy Combust. Sci.* **48** 21–83
- [4] Starikovskaia S M 2014 Plasma-assisted ignition and combustion: Nanosecond discharges and development of kinetic mechanisms *J. Phys. D. Appl. Phys.* **47**
- [5] Laux C O 2022 Applications of Plasma Discharges to Combustion *J. Combust. Soc. Japan* **64** 257–64
- [6] Barbosa S, Pilla G, Lacoste D A, Scouflaire P, Ducruix S, Laux C O and Veynante D 2015 Influence of nanosecond repetitively pulsed discharges on the stability of a swirled propane/air burner representative of an aeronautical combustor *Philos. Trans. R. Soc. A Math. Phys. Eng. Sci.* **373** 20140335
- [7] Xiong Y, Schulz O, Bourquard C, Weilenmann M and Noiray N 2019 Plasma enhanced auto-ignition in a sequential combustor *Proc. Combust. Inst.* **37** 5587–94
- [8] Lacoste D A, Moeck J P, Durox D, Laux C O and Schuller T 2013 Effect of Nanosecond Repetitively Pulsed Discharges on the Dynamics of a Swirl-Stabilized Lean Premixed Flame *J. Eng. Gas Turbines Power* **135**
- [9] Moeck J P, Lacoste D A, Laux C O and Paschereit C O 2013 Control of combustion dynamics in a swirl-stabilized combustor with nanosecond repetitively pulsed discharges *51st AIAA Aerosp. Sci. Meet. Incl. New Horizons Forum Aerosp. Expo. 2013* 1–11
- [10] Di Sabatino F and Lacoste D A 2020 Enhancement of the lean stability and blow-off limits of methane-air swirl flames at elevated pressures by nanosecond repetitively pulsed discharges *J. Phys. D. Appl. Phys.* **53** 355201
- [11] Vignat G, Minesi N, Soundararajan P R, Durox D, Renaud A, Blanchard V, Laux C O and Candel S 2021 Improvement of lean blow out performance of spray and premixed swirled flames using nanosecond repetitively pulsed discharges *Proc. Combust. Inst.* **38** 6559–66
- [12] Kim W, Snyder J and Cohen J 2015 Plasma assisted combustor dynamics control *Proc. Combust. Inst.* **35** 3479–86
- [13] Barbosa S 2008 *Étude Expérimentale De La Dynamique De Combustion D'Un Injecteur Multipoint Étagé De Turbine À Gaz* (Ecole Centrale Paris)
- [14] Providakis T 2013 *Etude de la dynamique de flamme swirlée dans un injecteur diphasique multipoints étagé*
- [15] Renaud A 2016 *High-speed diagnostics for the study of flame stabilization and transient behaviour in a swirled burner with variable liquid-fuel distribution* (Ecole Centrale Paris)
- [16] Minesi N Q, Blanchard V P, Pannier E, Stancu G D and Laux C O 2022 Plasma-assisted combustion with nanosecond discharges. I: Discharge effects characterization in the burnt gases of a lean flame *Plasma Sources Sci. Technol.* **31** 045029
- [17] Renaud A, Ducruix S, Scouflaire P and Zimmer L 2015 Flame shape transition in a swirl stabilised liquid fueled burner *Proc. Combust. Inst.* **35** 3365–72
- [18] Mesquita L C C, Aymeric V, Zimmer L and Ducruix S 2020 Numerical analysis of flame shape bifurcation in a two-stage swirled liquid burner using Large Eddy Simulation *Proc. Combust. Inst.* **000** 1–8
- [19] Cunha Caldeira Mesquita L 2021 *Simulation and analysis of the shape, performance, and stability of flames in a two-stage lean-burn aeronautical combustor* (CentraleSupélec, Université Paris-Saclay)
- [20] Santhosh R, Miglani A and Basu S 2014 Transition in vortex breakdown modes in a coaxial isothermal unconfined swirling jet *Phys. Fluids* **26** 043601
- [21] Rajamanickam K and Basu S 2018 Insights into the dynamics of conical breakdown modes in coaxial swirling flow field *J. Fluid Mech.* **853** 72–110
- [22] Mesquita L C C, Vié A and Ducruix S 2022 Flashback-induced flame shape transition in a two-stage LPP aeronautical combustor *Proc. Combust. Inst.* **000** 1–10
- [23] Blanchard V P, Minesi N, Bechane Y, Fiorina B and Laux C O 2022 Experimental and numerical characterization of a lean premixed flame stabilized by nanosecond discharges *AIAA SCITECH 2022 Forum* (Reston, Virginia: American Institute of Aeronautics and Astronautics) pp 1–14
- [24] Bechane Y and Fiorina B 2022 Numerical analysis of turbulent flame enhancement by nanosecond repetitively pulsed plasma discharges *Proc. Combust. Inst.* **000** 1–12