



HAL
open science

Ferroelectrics for multi-energy harvesting

Matthieu Fricaudet, Maja Koblar, Katarina Žiberna, Samir Salmanov,
Sharath Kattemanne Chandrashekar, Delong He, Jens Kreisel, Brahim Dkhil,
Tadej Rojac, Mojca Otoničar, et al.

► **To cite this version:**

Matthieu Fricaudet, Maja Koblar, Katarina Žiberna, Samir Salmanov, Sharath Kattemanne Chandrashekar, et al.. Ferroelectrics for multi-energy harvesting. International Symposium on Applications of Ferroelectrics (ISAF), Jun 2022, Tours, France. hal-04089992

HAL Id: hal-04089992

<https://centralesupelec.hal.science/hal-04089992v1>

Submitted on 5 May 2023

HAL is a multi-disciplinary open access archive for the deposit and dissemination of scientific research documents, whether they are published or not. The documents may come from teaching and research institutions in France or abroad, or from public or private research centers.

L'archive ouverte pluridisciplinaire **HAL**, est destinée au dépôt et à la diffusion de documents scientifiques de niveau recherche, publiés ou non, émanant des établissements d'enseignement et de recherche français ou étrangers, des laboratoires publics ou privés.

Context/Introduction

Available energy in the environment



Power generation and consumption¹

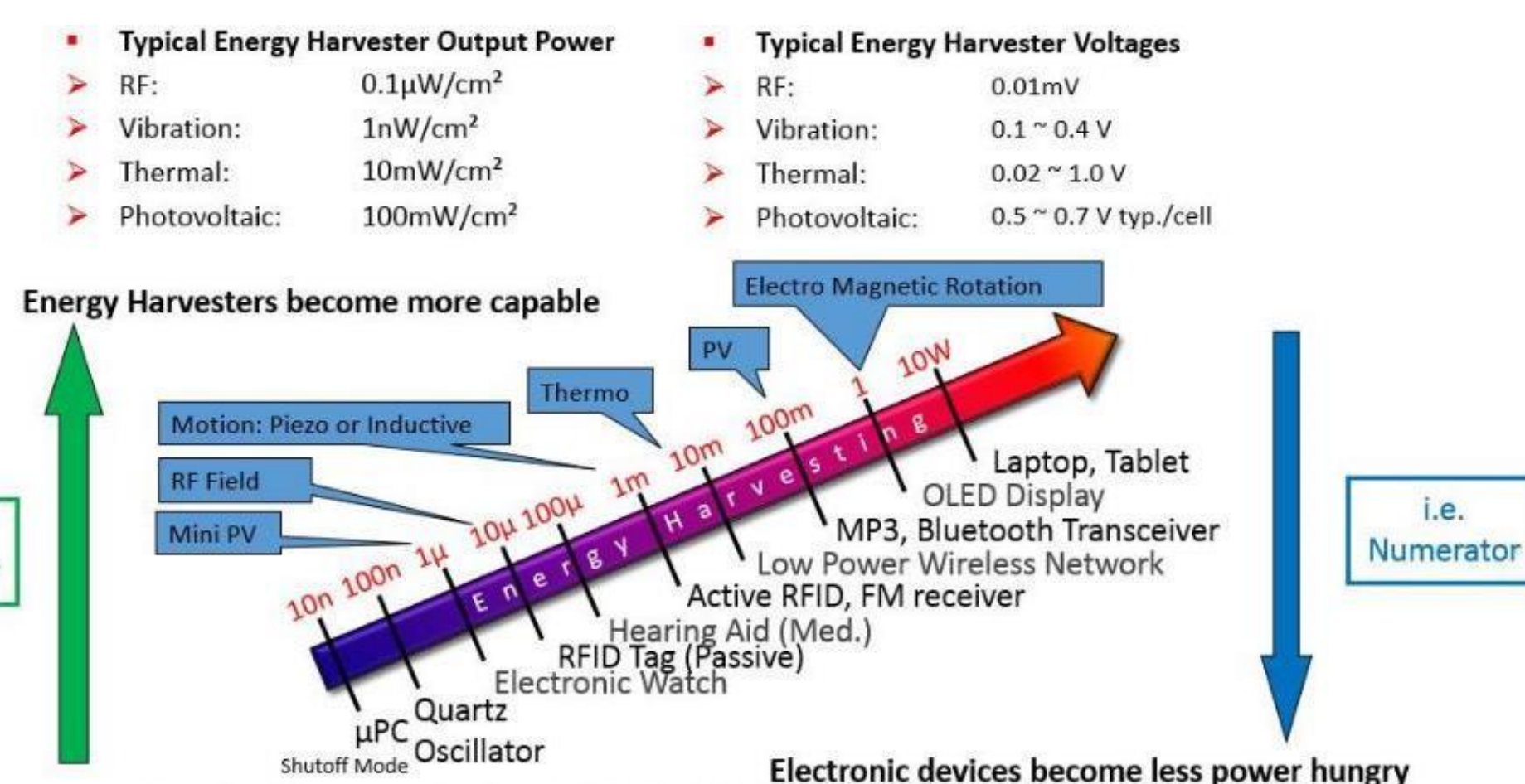

- A lot of free energy is available in the environment:
- Wind
 - Water flows
 - Body heat
 - Exhaust heat and vibrations
 - Light
 - Human movements
 - Human and animal heat

Energy consumption of sensors and small actuators are now in the same range as the energy available through energy harvesting methods.

Interest of ferroelectrics

Energy conversion methods

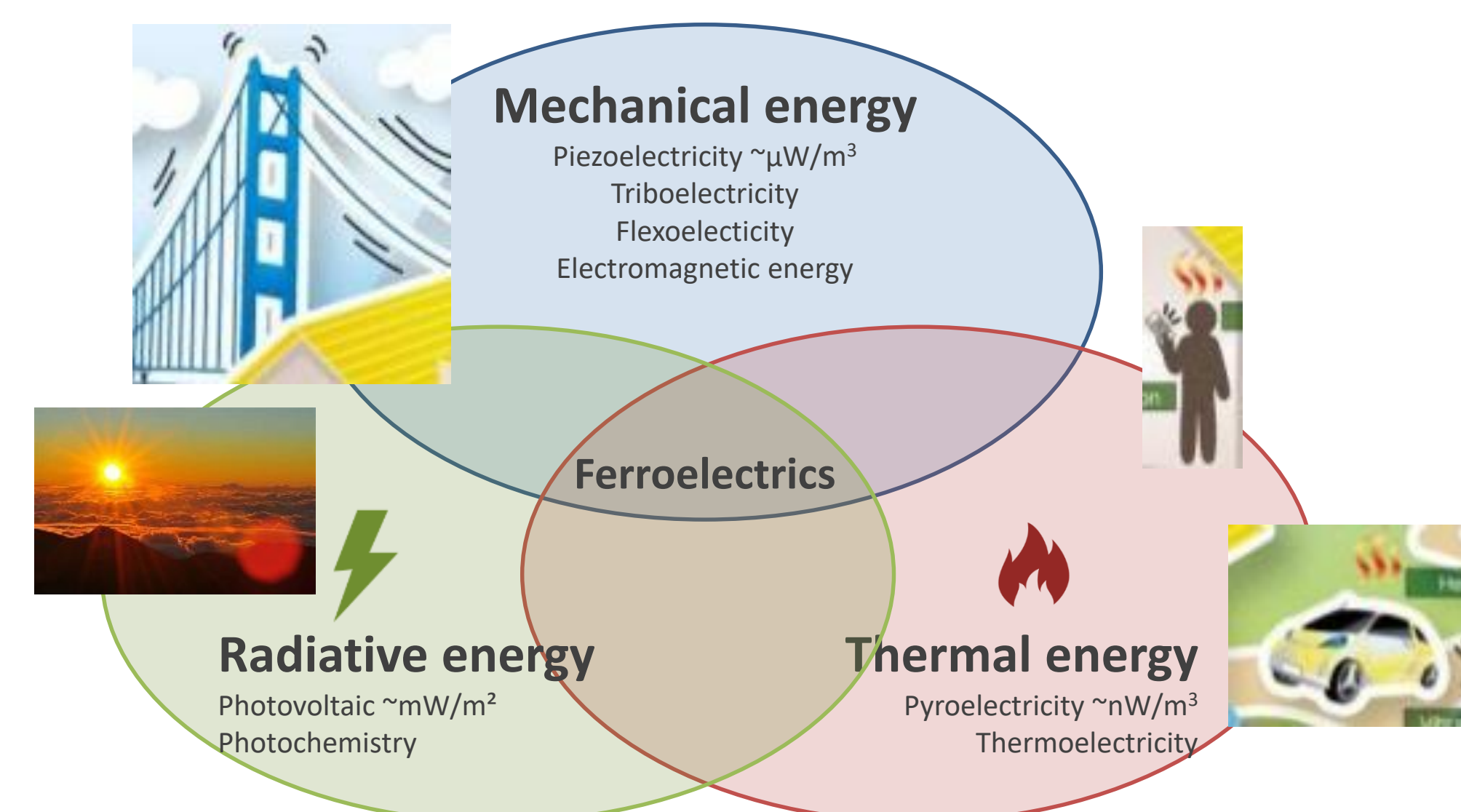

PVDF-based polymers²

Structure and microstructure

Polymer
-CH₂-CF₂- (PVDF)

180° rotation of molecular chains

Compositions

Notation	VDF (wt %)	TrFE (wt %)	CFE (wt %)
80/20	79.6	20.4	/
75/25	75.1	24.9	/
70/30	70	30	/
55/45	54.5	45.5	/
CFE	64.6	26.2	9.2

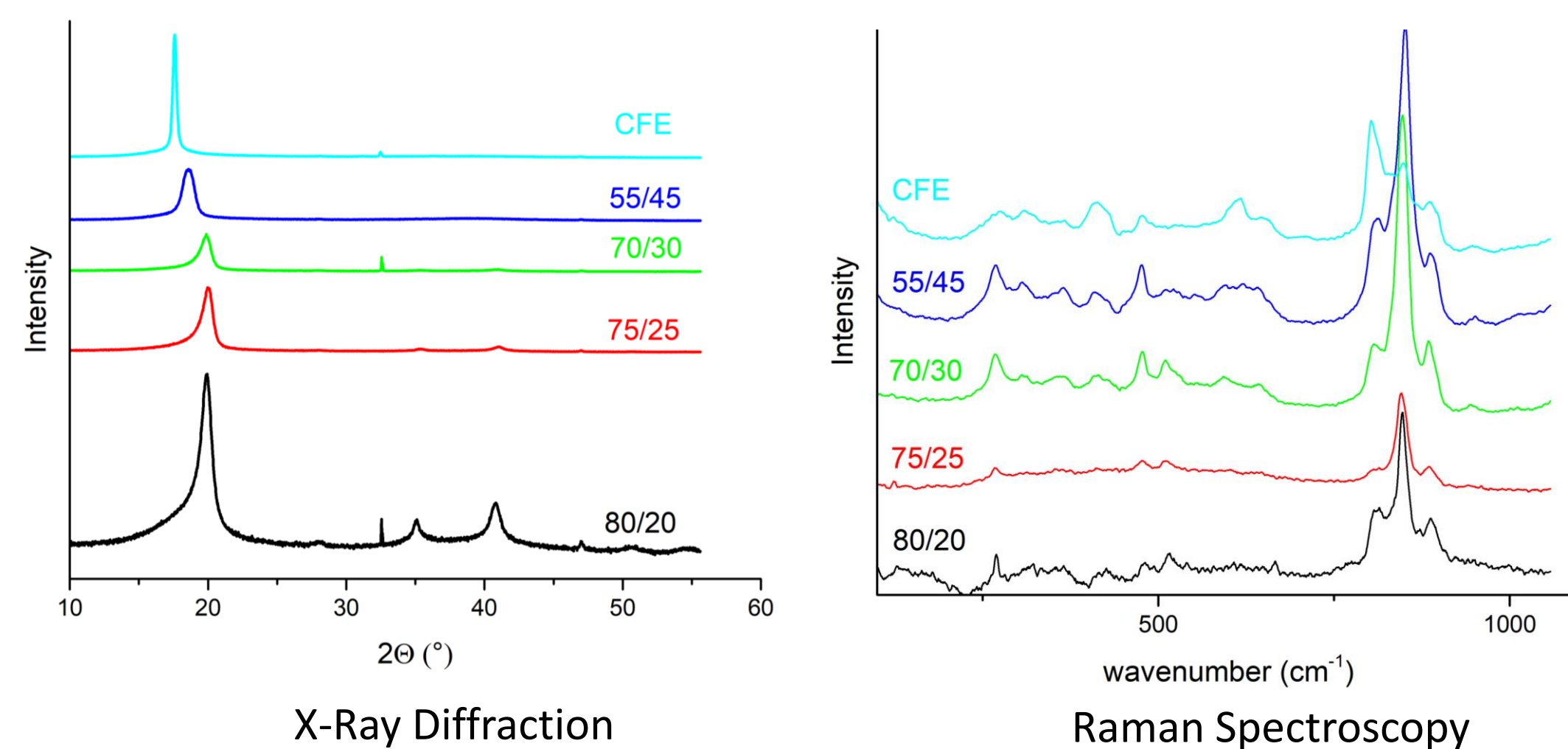

Scanning Electron Microscopy

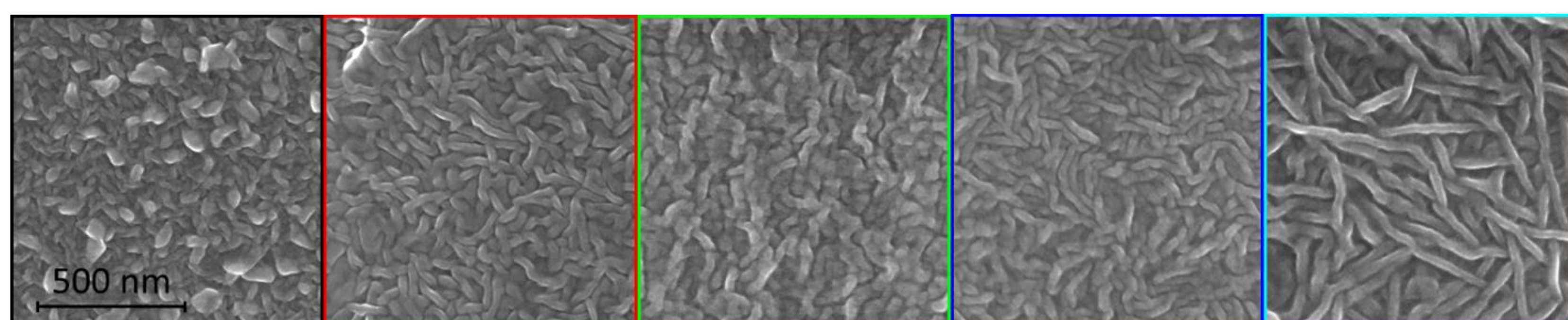

PVDF-TrFE/BiFeO₃ composites³

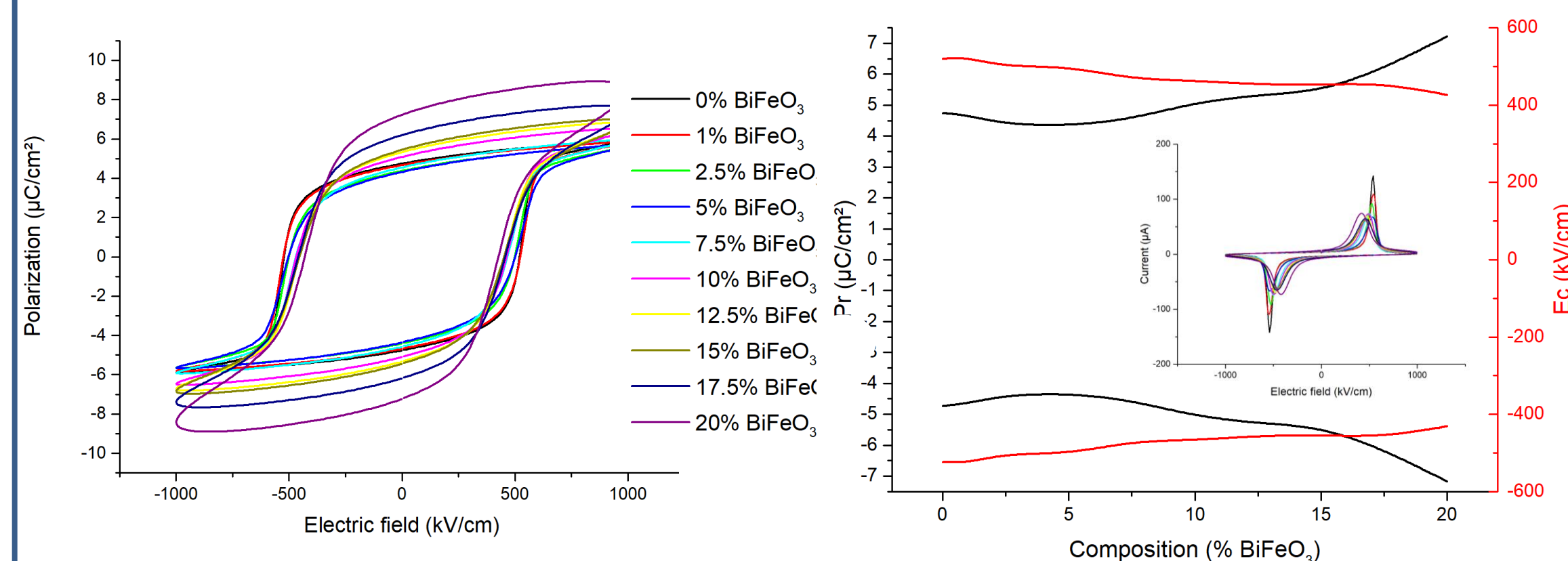
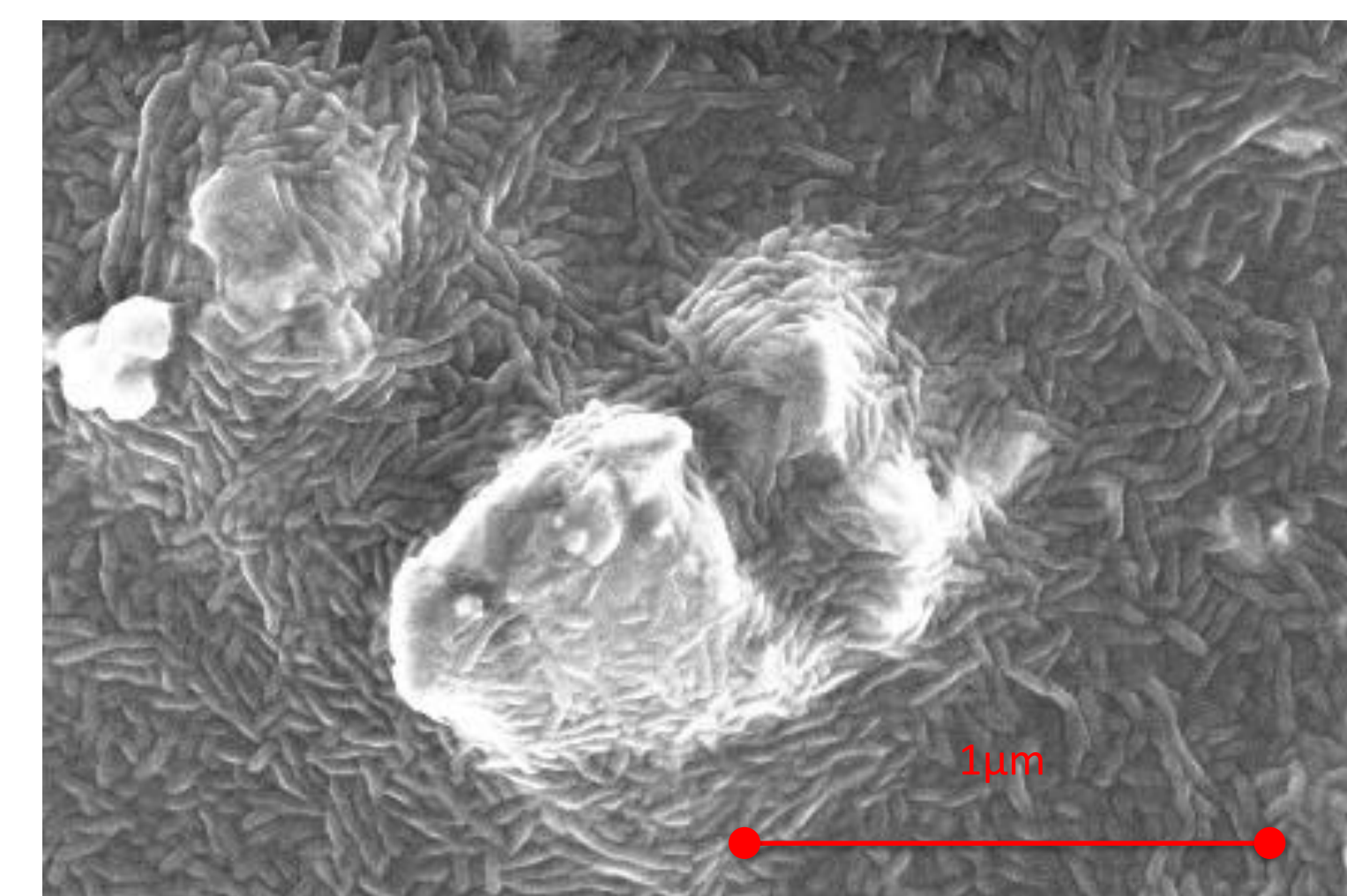

Piezoelectric response

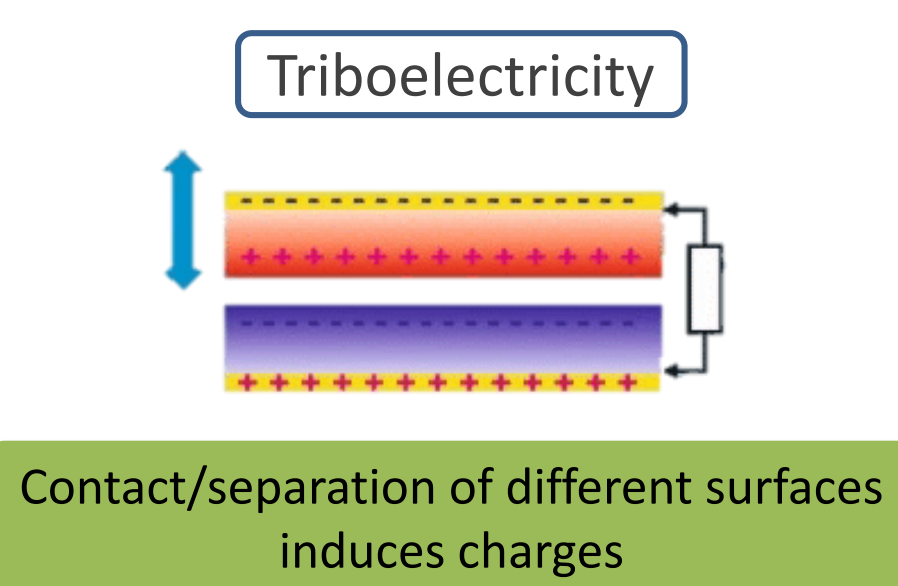
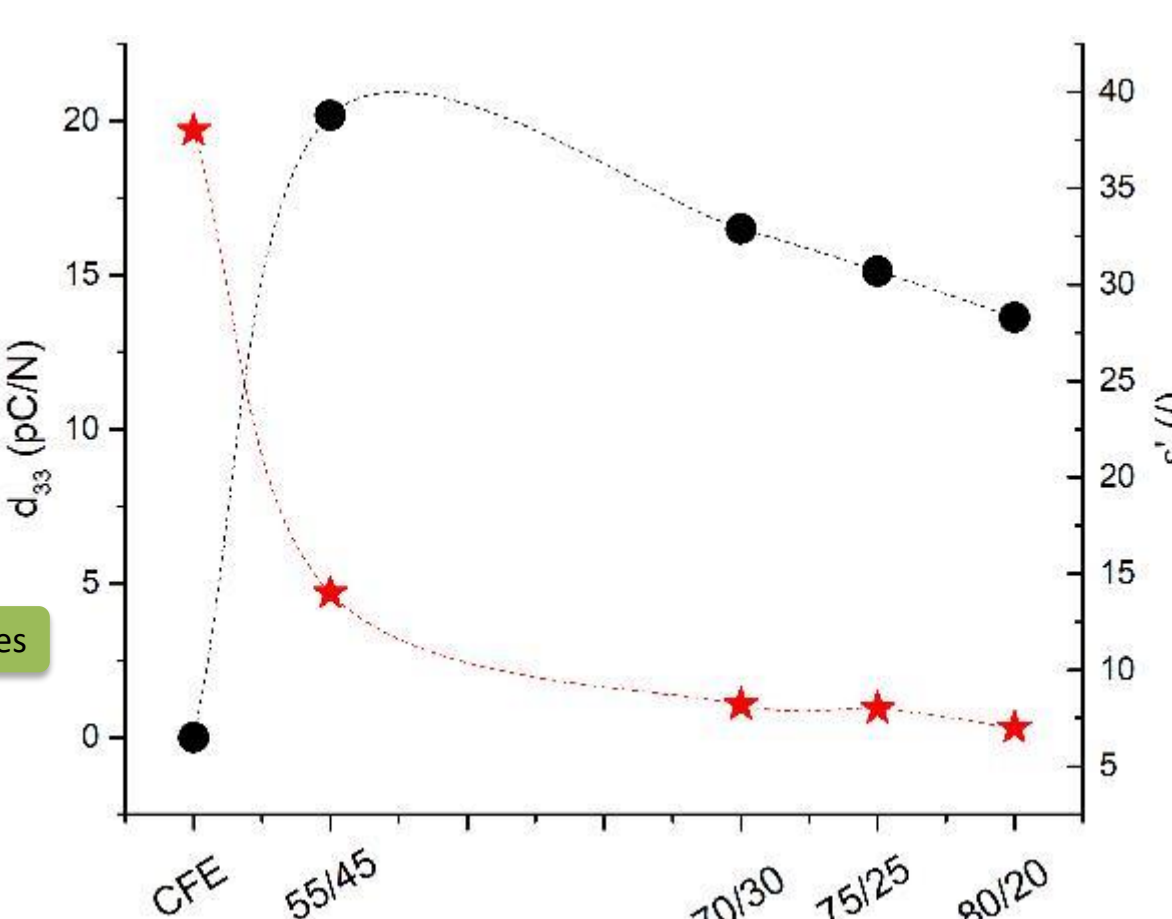
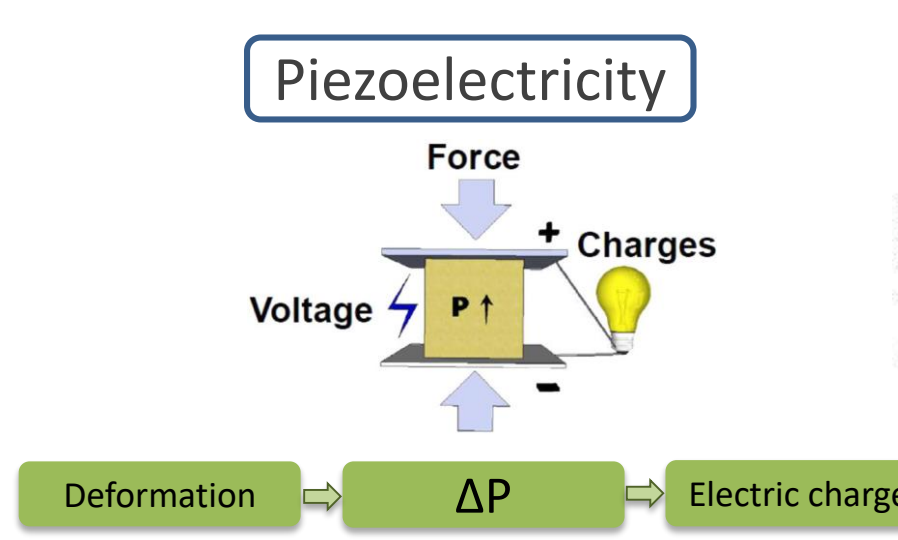

Triboelectrically induced signal excited in contact-separation mode.

Triboelectric response

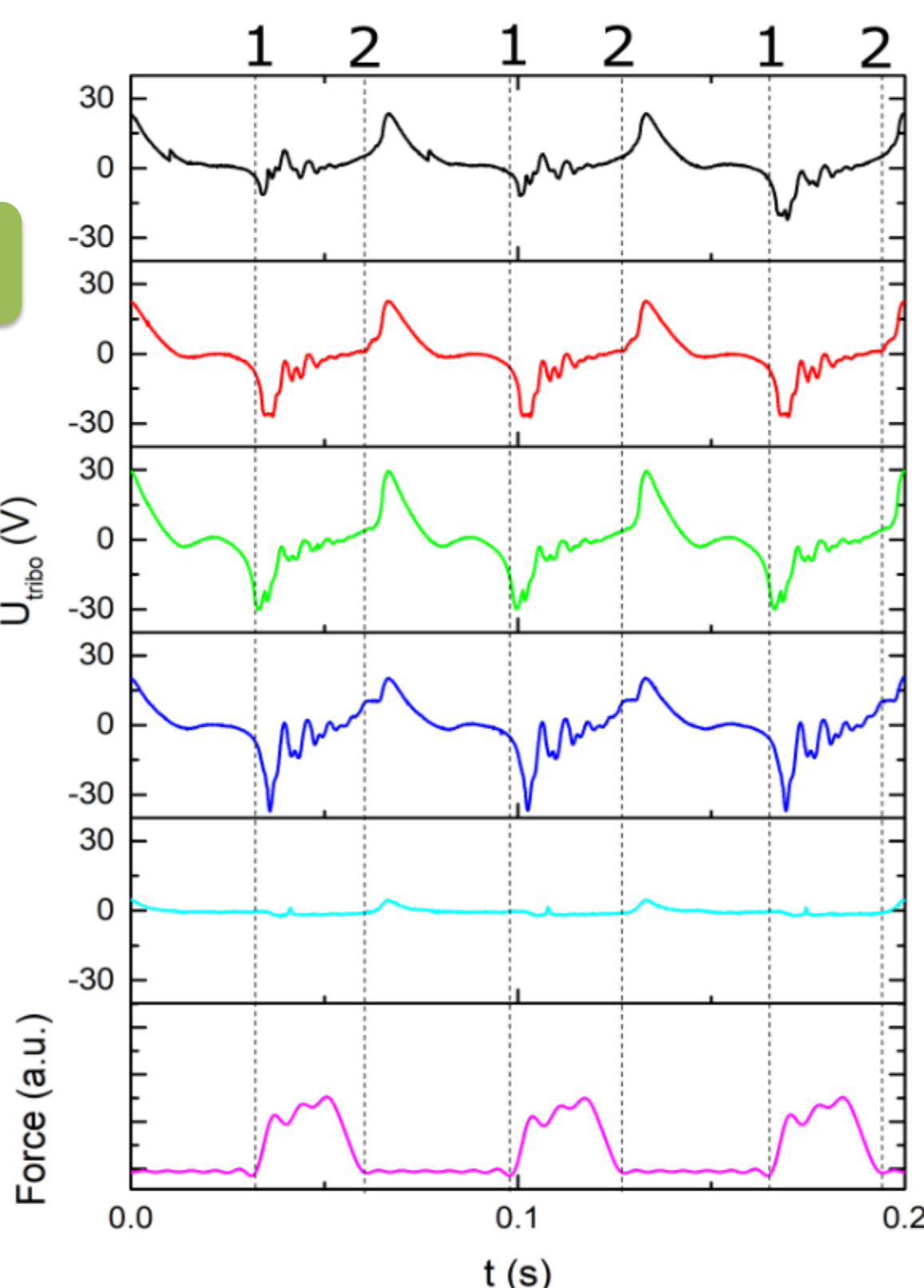

Pyroelectricity

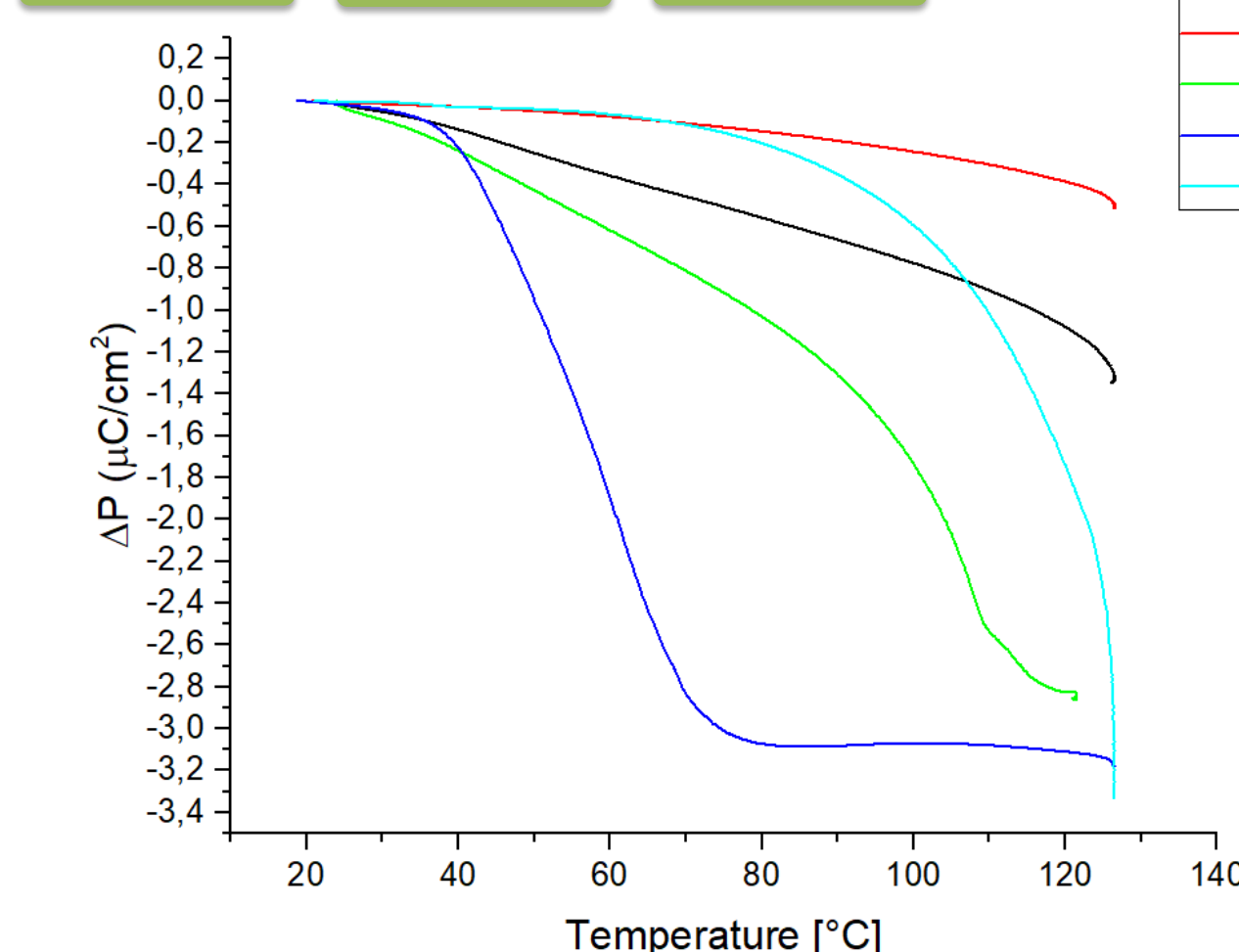
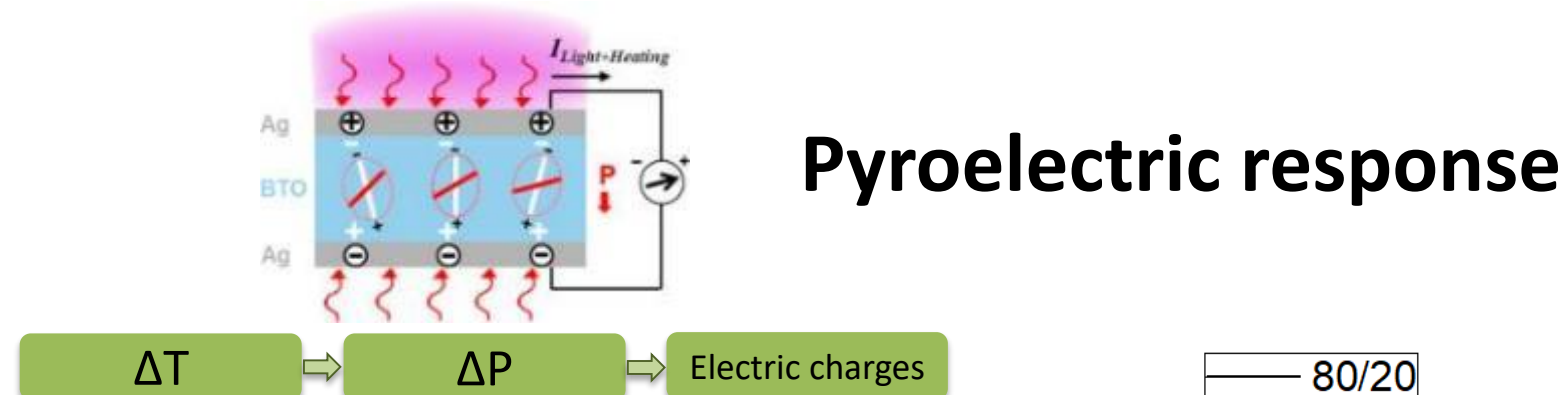

Temperature dependence of polarization

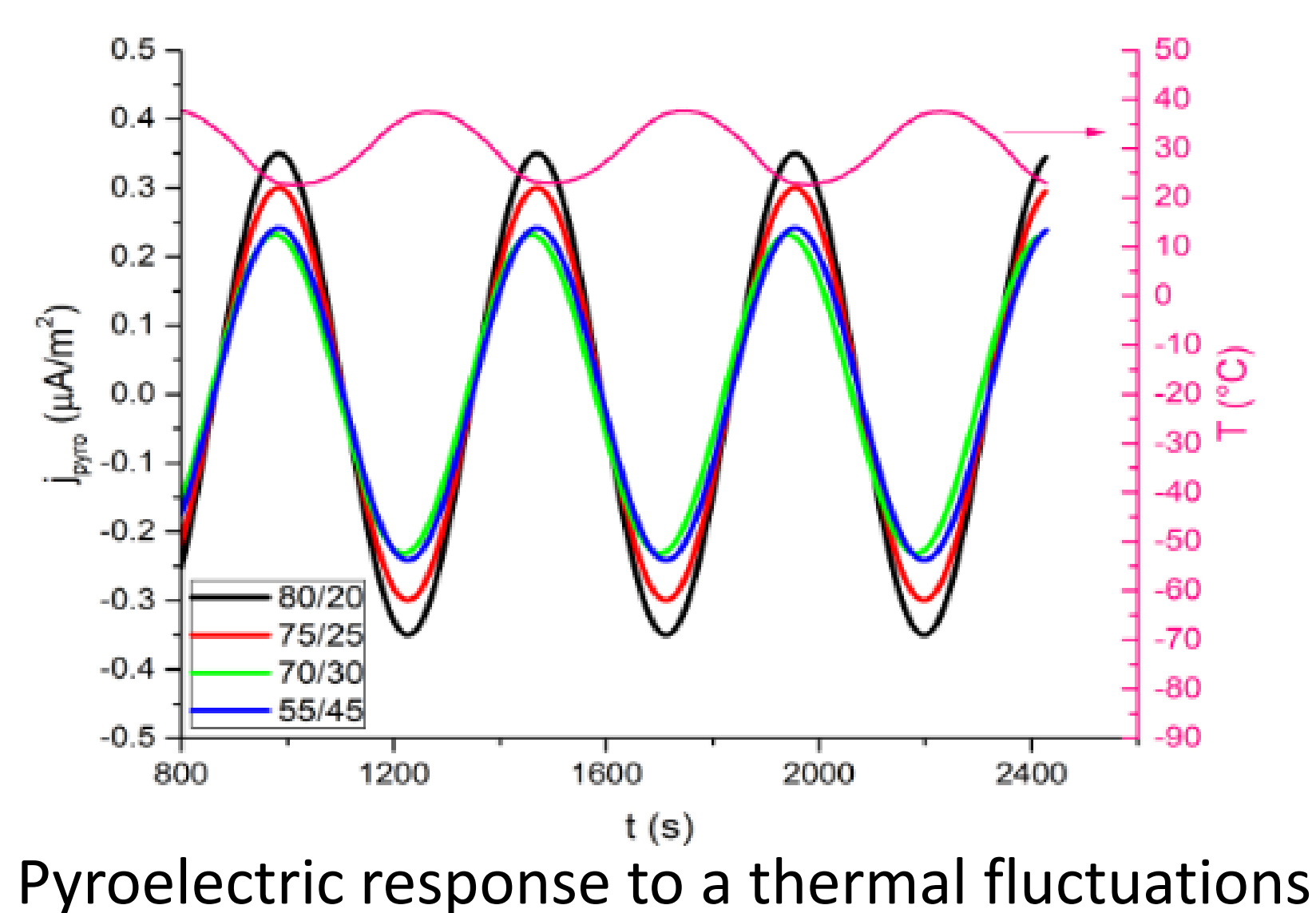

Pyroelectric response

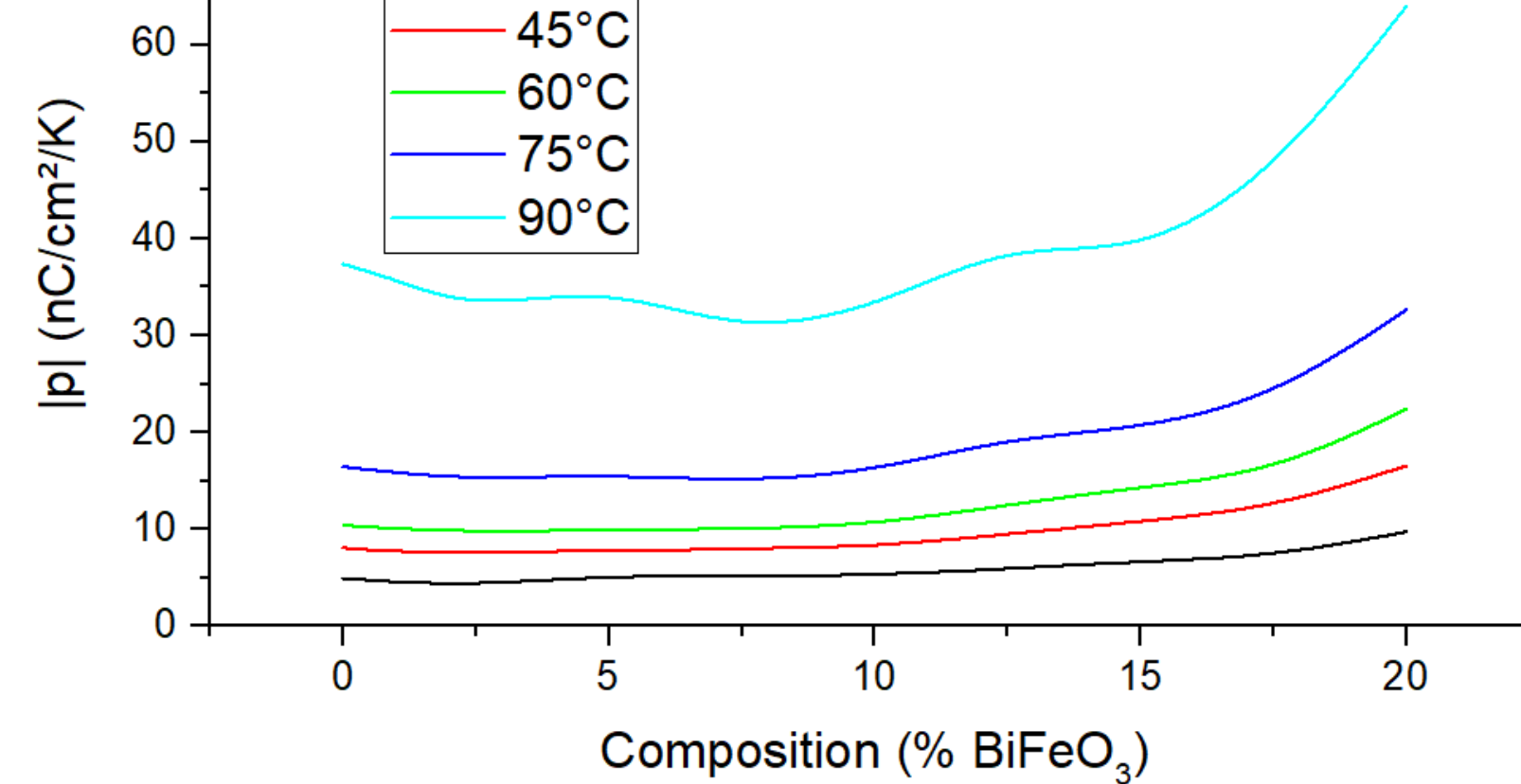

Piezoelectric response

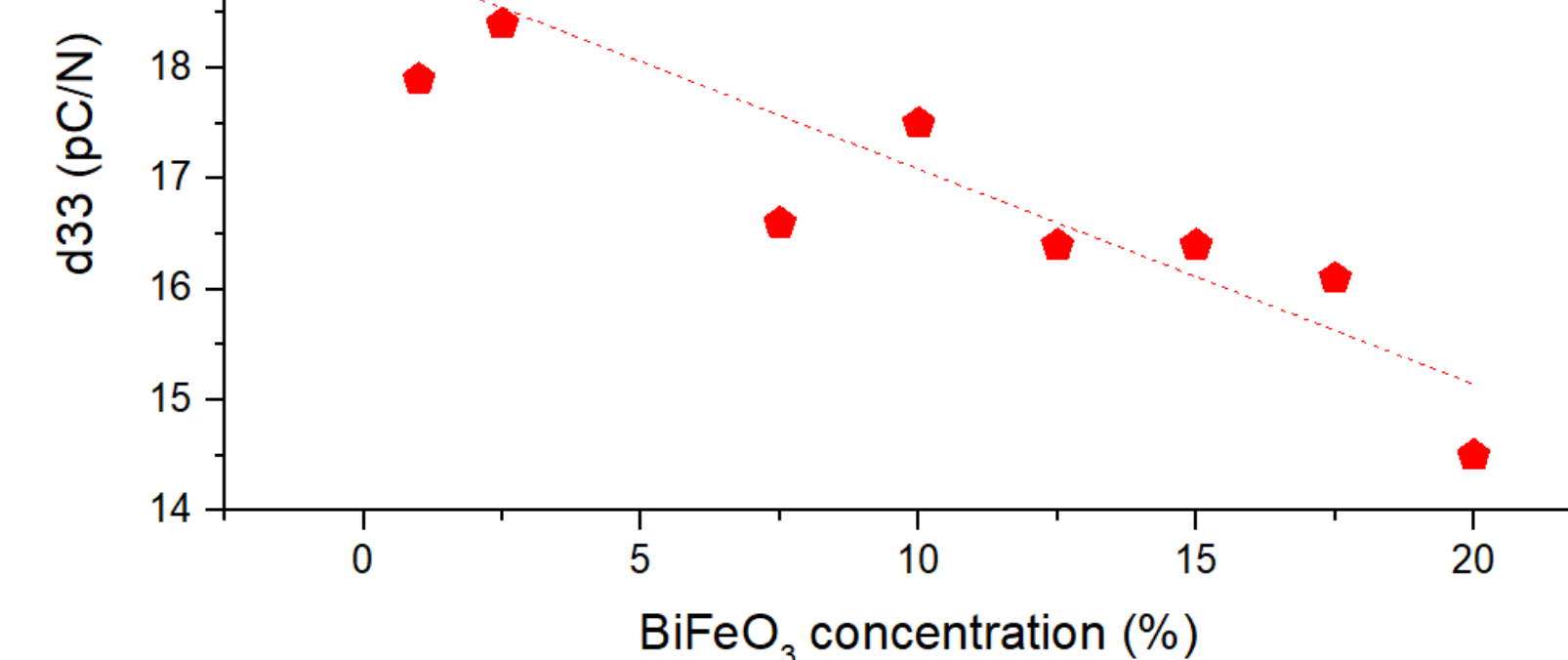

Work in progress

- We have identified at least three ways we can use sequentially or simultaneously to harvest energy with ferroelectrics: **piezoelectricity, pyroelectricity and triboelectricity.**
- We have fabricated various systems (PVDF-based polymers, oxide-polymer-based composites, etc.) and studied their **functional properties.**

References

- [1] M. Hayes, "Synergies between energy harvesting and power electronics, Tyndall National Institute, IEEE PELS Young professionals webinar, Oct. 20, 2016
- [2] M. Fricaudet et al., submitted
- [3] M. Fricaudet et al., to be published